

2024

Specification  
Guide

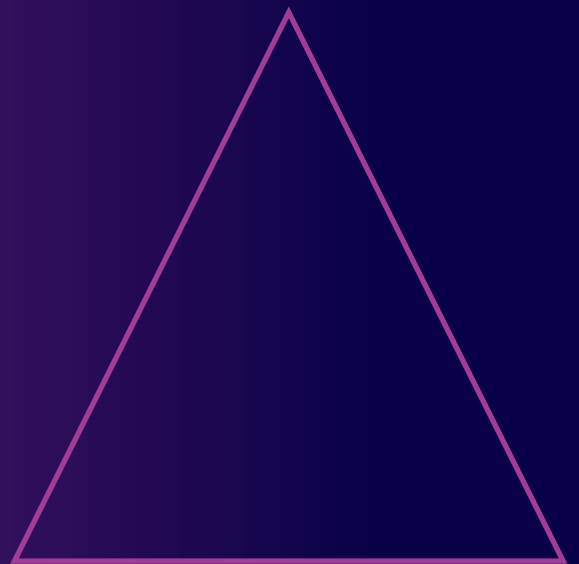



# INNOVATION THROUGH ILLUMINATION™









## Color Key



### 12VDC

Lighting that uses 12VDC power supplies.



### 24VDC

Lighting that uses 24VDC power supplies.



### 120V

Lighting that uses standard 120V wall outlets.



### White Tunable

Lighting that enables users to adjust the color temperature.



### RGB Tunable

Lighting that enables users to adjust the hue of lights.



### Required Accessories

Accessories required for the light to work.



### Optional Accessories

Accessories that add functionality but not required for the light to work.

# Table of Contents

About Us.....11

## SINGLE COLOR LIGHTING

Puck Lighting ..... 24

### 12VDC

3W Power Pockit® .....26  
 5W Power Pockit® .....28  
 Pockit® Point .....30  
 Pockit® Spot .....32  
 Pockit® Adapt.....34  
 3W EquiLine Puck .....36

### 120V

Pockit® 120-M.....38

Linear Lighting ..... 46

### 12VDC

FineLine 2.0 .....48  
 SimpLED 2.0 .....50  
 Eurolinx.....52  
 Elli® Series .....54  
 EquiLine FineLine .....56

### 120V

T5 Trescent® LED.....58

Tape Lighting ..... 66

### 12VDC

FlexTape® .....68  
 Edge Emitting FlexTape® .....74  
 EquiLine Tape LED.....75  
 COB FlexTape® .....78

### 24VDC

COB FlexTape® .....80

Flexible Silicone Lighting..... 87

### 12VDC

Side-Emitting Neoloop.....88  
 Top-Emitting Neoloop.....90

### 24VDC

Side-Emitting Neoloop.....92  
 Top-Emitting Neoloop.....94

Panel Lighting..... 98

### 12VDC

Etch.....100

### 24VDC

Snap .....106

Snip.....110

## TUNABLE LIGHTING

White Tunable ..... 114

### 12VDC

12VDC White Tunable FlexTape® .....116

### 24VDC

24VDC White Tunable FlexTape® .....118

4W CCT Power Pockit® .....120

RGB Tunable..... 124

### 12VDC

12VDC RGB Balance Tunable FlexTape® .....126

### 24VDC

24VDC RGB Balance Tunable FlexTape® .....128

24VDC RGB Standard Tunable FlexTape® .....130

Extrusions ..... 134

Infinex.....136

Components ..... 148

Power Supplies .....150

Controllers.....160

Install Accessories.....176

Technology ..... 180

Swidget .....182

Sales Support on page 192

# Layout Design Services

The increasingly popular application of LED lighting is new to many design professionals. Let our Lighting Layout Assistance Program guide you in specifying the ideal product and wiring schematic for your next residential or commercial project.

Typical Setup:

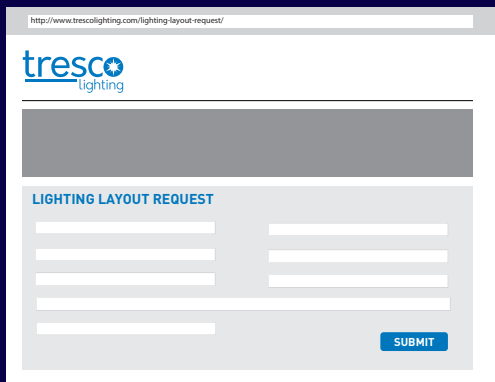

Visit: [trescolighting.com/layout](http://www.trescolighting.com/layout)



Fill out the form and upload your drawings.

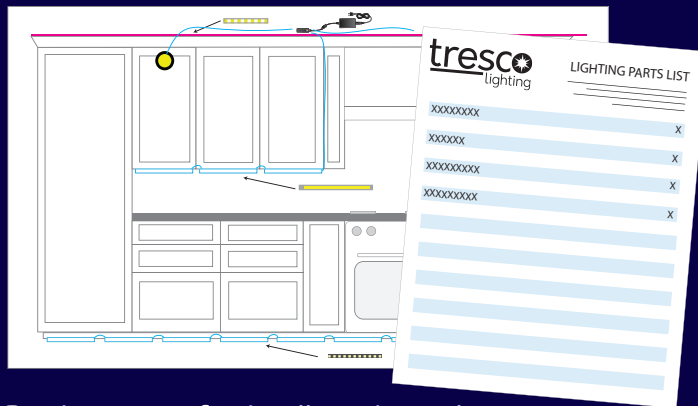

Receive your professionally engineered schematic and matching parts list.

GET STARTED  
TODAY



[trescolighting.com/layout](http://trescolighting.com/layout)

# Product Information

## Product Color Finishes

Tresco's lighting products are available in eight standard color finishes: White, Black, Chrome, Gold, Nickel, Antique Brass, Aluminum and Oil-Rubbed Bronze. Please refer to the individual Product Sections for color availability of each product.



White (WH)



Black (BL)



Chrome (CH)



Gold (GD)

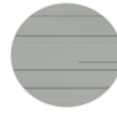

Nickel (NI)  
(Brushed)

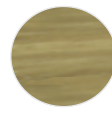

Antique Brass (AB)



Aluminum (AL)  
(Mill)



Oil-Rubbed  
Bronze (ORB)

## ETL, UL, and QPS-Testing, Inspection and Certification

- ETL is the largest worldwide
- UL is the largest in the USA
- Both are Nationally Recognized Testing Laboratories (NRTL) as recognized by OSHA
- Both are recognized by local inspectors throughout North America
- No mark is better than the other



Intertek

### Tresco Products Tested and Certified for Canada and the United States

ETL or UL marks serve as proof of product compliance to Canadian and U.S. standards. When products bear these marks, this indicates to the consumer that the products have passed a complete and thorough set of tests and certification requirements.



All TRESKO® lighting systems carry UL, ETL or QPS safety certifications. In addition, a majority of our individual lighting components (lights, power supplies, and accessories) are also registered and certified by ETL and/or UL.



### UL's Recognized Component Mark

The UL Recognized Component Mark is used on components that are a part of larger products or systems. It is certified by UL to both Canadian and U.S. requirements.

### CE Mark



CE Marking permits a product to be sold throughout the European Union. It is a conformity mark noting the product complies with all applicable European Directives.

\* The ETL Mark is a registered trademark of Intertek.  
The UL Mark and Recognized Component Mark are registered trademarks of Underwriters Laboratories Inc.  
All product dimensions and specifications are subject to change without prior notice.

# Lighting 101

## Diode Life:

LEDs fade as opposed to abruptly burning out. "End of Life" refers to the number of hours until the LED has completely faded out, although it will have been too dim to use for many hours leading up until that point. "Useful Life", on the other hand, refers to the number of hours until the LED reaches 70% of its initial light output, which is a much more practical indicator for the consumer (defined as L70).

50,000 Hours = 17 Years (8 hours a day)

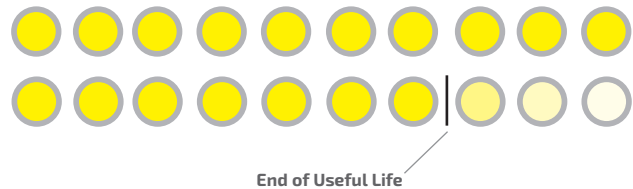

## Color Consistency:

LEDs, as a natural result of the manufacturing process, have inconsistent color from one diode to the next. Top brand LED suppliers, like the ones used by Tresco®, combat this by means of a process known as "binning" - inspecting each individual diode and matching them to ensure consistency.

Tresco:



Cheap LEDs:



## Lumen Output:

Lumen is the measure of visible light output emitted from a fixture. For under cabinet lighting, where the goal is to illuminate a workspace to perform specific tasks, the brighter, the better. For soffit, toe kick or other accent lighting, a moderate output is better.

**TASK:** 150+ LUMENS

**ACCENT:** UNDER 150 LUMENS

## Beam Spreads:

Using puck lights with tight beam spreads under wall cabinets can create unsightly dark spots on the backsplash between lights. Beam spreads of 90 degrees or greater will reduce the dark spots. For spotlight applications, such as in-cabinet or display lighting, a beam spread of 20-40 degrees is desirable.

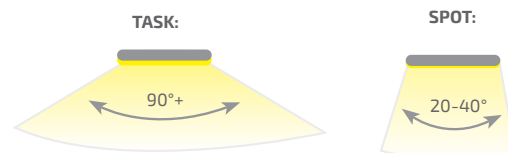



# Color Temperature

Color temperature is the rating a particular color renders on the Kelvin scale. These color temperatures alter how an object or room is perceived when illuminated, and Tresco® offers a wide range to choose from. To find the appropriate color temperature for your application, please reference the table below:

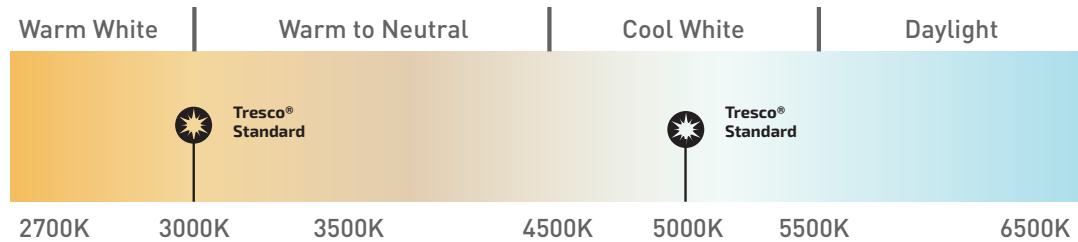

**2700K**  
**Warm White**  
 Recommended for Earth Tones  
 Mimics Incandescent  
 Highlights Wood Grains  
 Primarily for Residential Use  
 Not Recommended for White



**3000K**  
**Warm White**  
 Recommended for Earth Tones  
 Slightly "Whiter" Than Incandescent  
 Highlights Wood Grains  
 Primarily for Residential Use  
 Not Recommended for White



**3500K**  
**Warm to Neutral**  
 Transitional Between Warm and Cool  
 Will Equally Highlight Earth Tones and Cool Tones  
 Recommended for Residential and Commercial Use  
 Will Give White an Off-White Look



**5000K**  
**Cool White**  
 Highlights Whites/Blue/Cool Tones  
 Primarily For Commercial Use  
 Recommended for White  
 Not Recommended for Wood Grain/Earth Tones



**6500K**  
**Daylight**  
 Has Bluish Tint (Sky Color)  
 Primarily Used for Backlighting/Signs  
 Not Recommended for Residential Use



# What is Luniform?

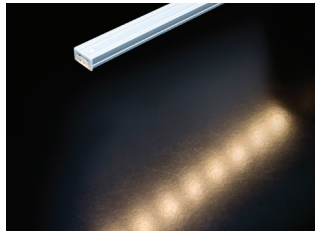

"Dotted" appearance

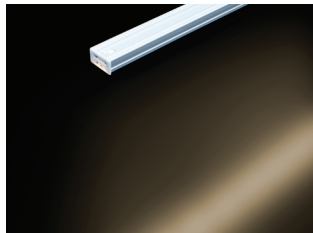

Luniform



**luniform** (loo-nuh-fawrm) n.  
The technology to eliminate "dotted" appearances and reduce unwanted glare within light emitting diode fixtures.



Eurolinx

## Secondary Optics

Secondary optics are lighting components uniquely designed to diffuse LED diodes and reduce glare, such as special lenses and proprietary films.

## Chip-On-Board Technology

Chip-On-Board technology allows for up to 10X the amount of LED diodes on a single circuit board or substrate, resulting in greater light output and a uniform beam spread.



Power Pockit® 5W

# WHO WE ARE







## Leader in LED Lighting

Tresco® Lighting is the leader in premier lighting solutions for store fixtures, commercial applications, residential cabinetry, laboratory and hospitality furniture. With over 30 years of "Innovation Through Illumination" we proudly design and manufacture a full line of superior quality LED lighting options that are UL/ETL listed. Tresco® Lighting is the trusted brand for all your project needs.

Tresco® was founded in 1989 to meet a growing demand for quality cabinet and casework lighting. In 1992, we designed and offered the first UL-listed, under cabinet track lighting system in North America. This ingenuity and success led to the rapid development and expansion of product lines targeting different segments of business. 30 years later, our goal remains the same: provide innovative, functional and design savvy products for the office, laboratory, hospitality, furniture, store fixture, millwork and kitchen industries. We welcome you to browse our catalog and learn more about our company and product offering.

## The Company We Keep

We are members in good standing with the most respected names in the business. Our customers can be confident that they're dealing with a professional, reputable, and reliable leader in the LED lighting industry.



# History

**1989**

Tresco® International opens operations

**1993**

Launched first product - Under Cabinet Track System UL issues first safety listing ever for a non-wall or ceiling track system to Tresco®

**1996**

Launched Lumaflex, one of the first rope lighting systems in the USA

**2003**

Construction on a modern facility begins that doubles our size

**2008**

Patent issued for Elli® Linkable Light System

**2009**

Patent issued for Modular Light Rail Light System

**2010**

Patent issued for iMAGine® Shelf Light System

**2011**

Tresco® acquired by Rev-A-Shelf®, LLC

**2013**

Patent issued for SimpLED Linear LED System

**2014**

Construction of new 300,000 square foot building

**2015**

Introduced Infinex, a custom extrusion lighting solution

**2016**

Introduced FREEDiM Series of wireless controllers

**2017**

Patents issued for Infinex extrusion system and FREEDiM wireless controllers

**2017**

Snap panel lighting wins KBIS "Best of Show"

**2019**

Patent issued for Etch panel



Tresco® International launches first product. (Halogen Track Light, 1993)

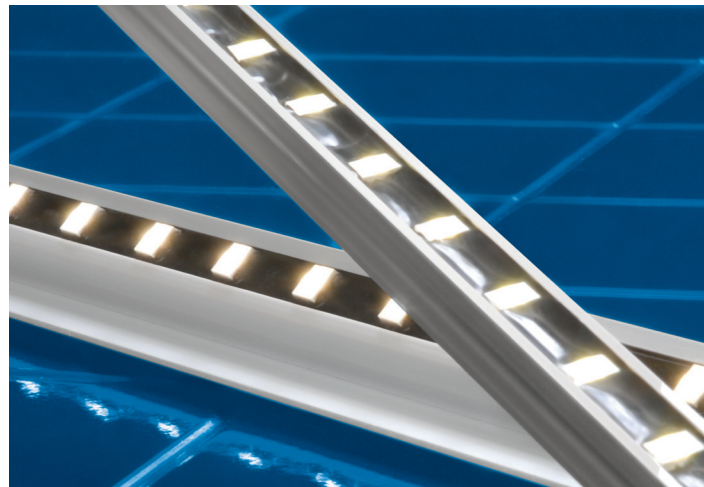

First of many U.S. patents awarded to Tresco®. (Elli® Series, 2008)

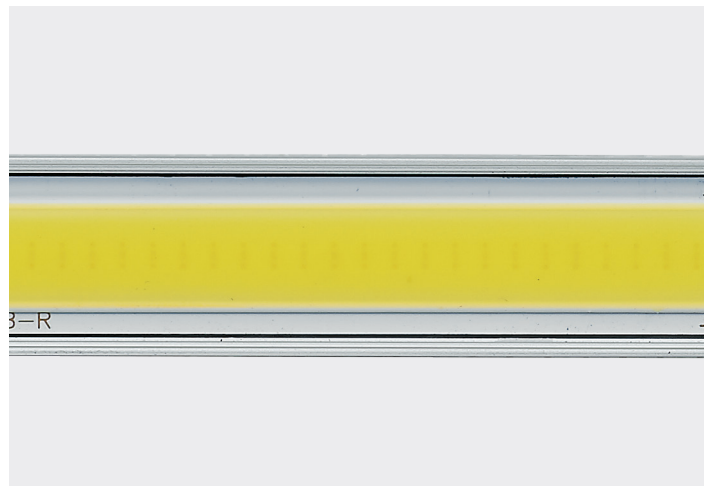

Tresco® launches new Luniform LED Technology. (SimpLED 2.0, 2014)

# WHAT WE DO

## Linear Lighting

Tresco® linear or "strip" lights are available in a range of styles, price points, outputs, and color temperatures.



## Pocket® Lighting

Tresco Pocket® or "puck" lights are available in a variety of configurations. Large or small, spot or accent, metal or plastic, linkable or non-linkable, Tresco® has a "Pocket®" light for you.

## Panel Lighting

Take your designs to new levels with panel lighting. From countertops and shelves to artwork and signs, backlighting provides both decorative and utility lighting in one application.



## Flexible Lights

With Tresco®'s FlexTape® or flexible silicone lighting, you can have the flexibility you need without sacrificing the quality you demand. Whether Backlighting a sign, edge lighting a display, or accent lighting Air Force One, Tresco®'s line of flexible lights are all you need.







## Store Fixtures

Tresco® products are the perfect addition to your store fixture lighting. If we don't stock what you need, we can custom design it for you. Tresco® Lighting is the solution.



## Commercial Furniture

From desks to shelves, high quality Tresco® products provide ideal lighting for the office at a low price.



## Hospitality

Whether the relaxing glow of a hotel room or the inviting radiance of a restaurant, lighting is an essential part of our lives and especially important when creating an atmosphere. Tresco® is here to help you create an enjoyable guest experience, accentuate your brand, and save you money.





## Residential Cabinets

Adding lighting to your residential cabinetry is easier than ever with Tresco® Lighting. Our standard power supply and connectors work with the entire line of LED lighting — no more trying to find what connector works with what power supply. Tresco® Lighting is easy as 1-2-3.



## Institutional

Warrantied, safety tested, and built to withstand demanding environments, Tresco® products are ideal for institutional locations. Whatever your application, our lights provide optimum task visibility at a minimal operational cost for cafeterias, libraries, hospitals, or laboratories.



## Residential Furniture

Incorporating lighting into your furniture raises the bar on the consumer experience for your brand. Worried about safety? So are we. That is why Tresco® Lighting products are UL or ETL listed.

**WHY  
CHOOSE  
US**





## Quality

Superior components ensure Tresco® lights are brighter with a wider light spread than the competition. We use world-renowned suppliers who employ static and dust-free clean rooms, proper binning, and use of high-grade phosphors to achieve efficiency, high lumen, and color consistency.

When it comes to LED, the diode makes the difference. That is why we use brands like Nichia and Cree.



## Independent Testing

We don't just say our lights are better — we prove it. Independent testing certification available for TM21, LM80, and LM79 photometrics to provide specification charts. Charts are printed next to our lights for proper specification of our products.

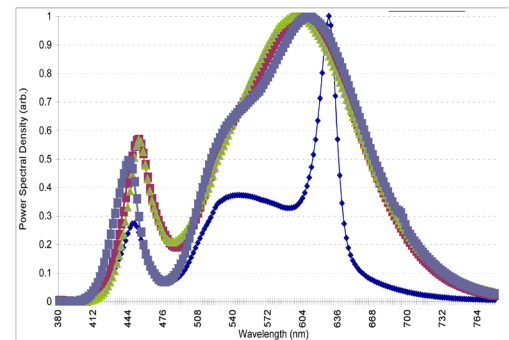

\*D Module Power Spectral Density.

## Safety Listings

At Tresco®, safety is a top priority. All of our products carry UL, ETL or QPS safety certifications for the United States and Canada.

CE marking permits a product to be sold throughout the European Union. It is a conformity mark noting the product complies with all applicable European directives.



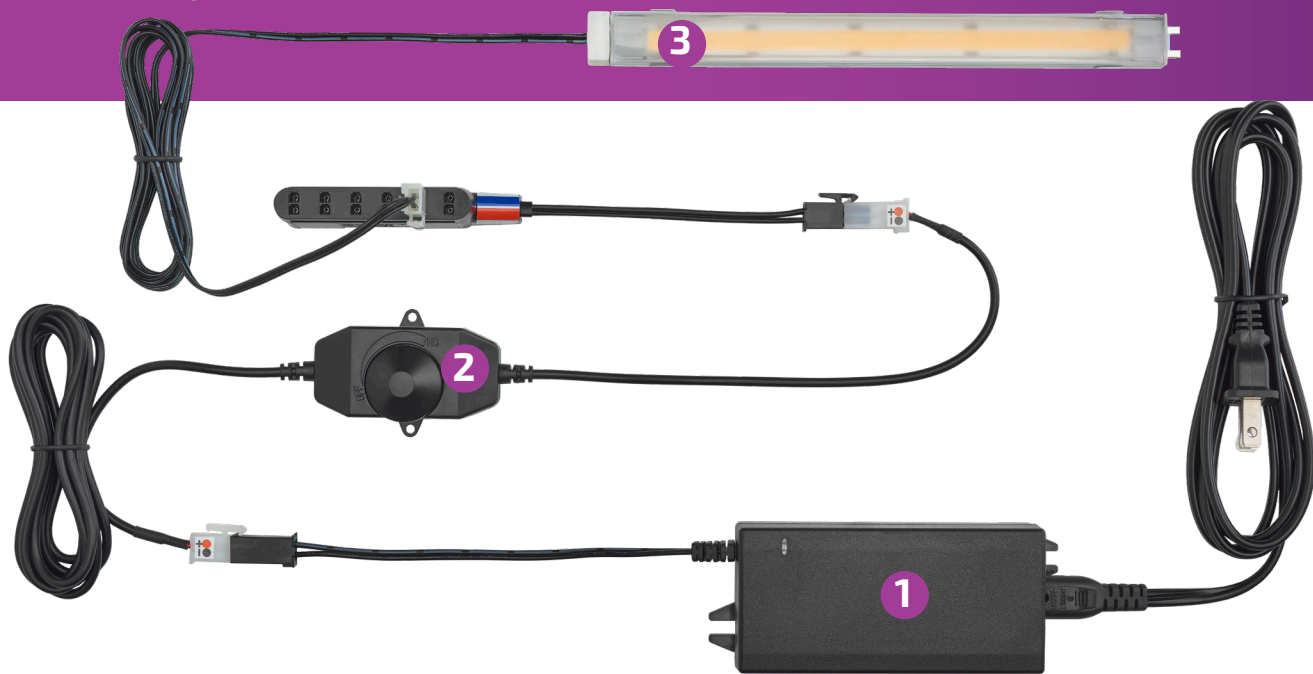

## We Make Lighting Easy

### Easy as 1 - 2 - 3.

- 1) Universal power supply
- 2) Controller connects to the power supply
- 3) Light fixture connects to the controller

### Universal System

Tresco®'s in-house design and manufacturing teams create LED lights to work with one power source. Other products require different power supplies for different lights, but Tresco®'s LED lights are designed to work with a single 12VDC or 24VDC power supply. No more wiring nightmares.

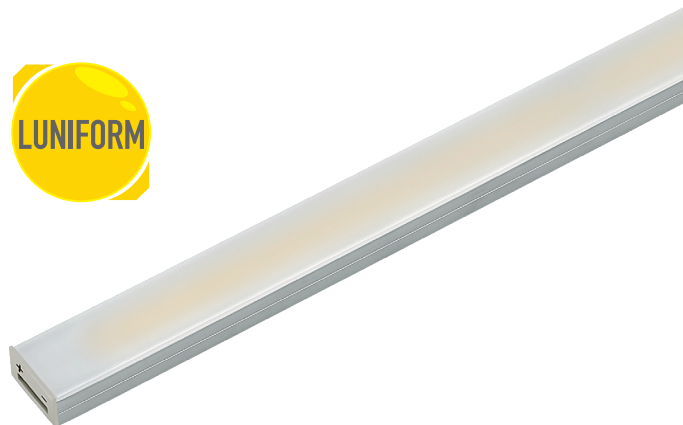

## In-House Design

We are not your typical lighting company. From art to part, we design and manufacture custom lighting solutions based on your specific needs.

## Luniform

Luniform is the technology to eliminate "dotted" appearances and reduce unwanted glare within light emitting diode fixtures.

**See Page 10 for more information.**

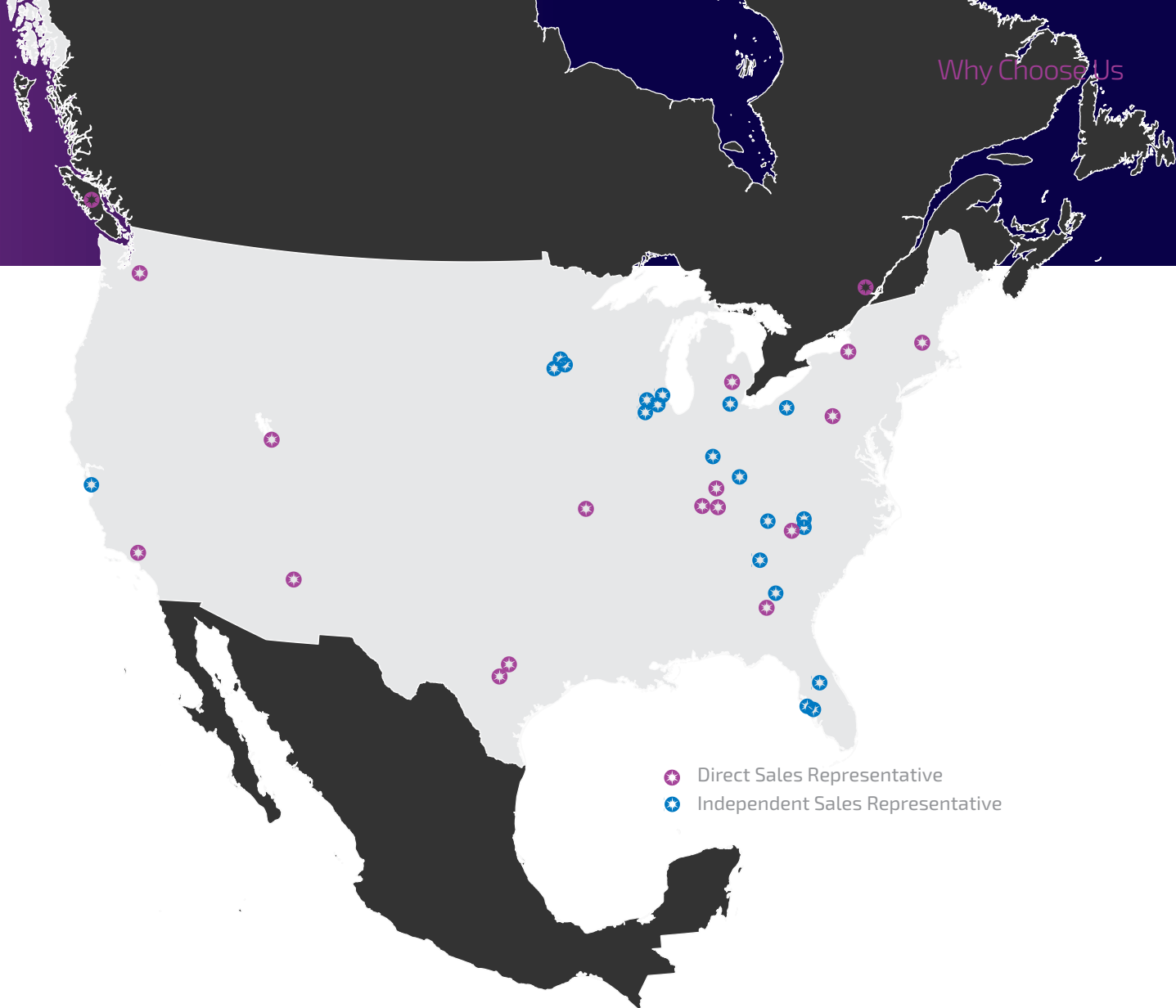

## Distribution Network

Tresco® products are stocked with over 100 distributors in North America, giving you same day or next day delivery.

## OEM Network

Our OEM network includes some of the largest and most respected manufacturers in the business. This helps us achieve economies of scale that result in cost savings for you.

## Our Team

Representatives from the Tresco® Lighting Sales and Customer Service teams are in the field and ready to help you find the right product for your application.









12VDC

120V

# PUCK



# Power Pockit® 3W

12VDC



3W	234 Lumens	<p>120°</p>
<p>The Power Pockit® 3W is a versatile choice offering flood and task lighting that can be used for interior cabinets, under cabinets and store displays. This 3W energy efficient LED provides a crisp, uniform wash over illuminated objects.</p>		

### Features:

- Slim Profile – 1/4" (7 mm)
- Wide 120° beam spread
- High output (234 lumens)
- Luniform output – no "dots"
- Durable milled aluminum construction
- Recess or surface mount

### Typical Applications:

- Displays
- Store fixtures
- Interior/under cabinets
- Task lighting
- Closets (UL listed for use within closet storage spaces)

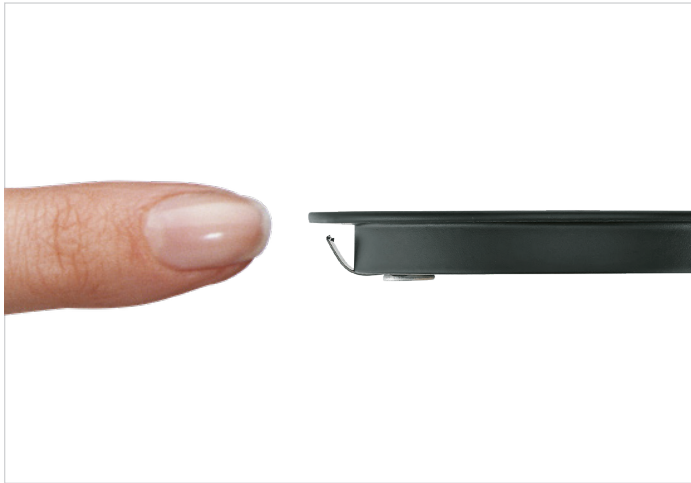

Thin profile: Just 1/4" (7 mm) depth when recessing  
3/8" (10 mm) when surface mounting



### Available Finishes:

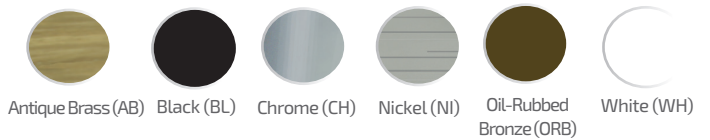

Antique Brass (AB) Black (BL) Chrome (CH) Nickel (NI) Oil-Rubbed Bronze (ORB) White (WH)

### Dimensions:

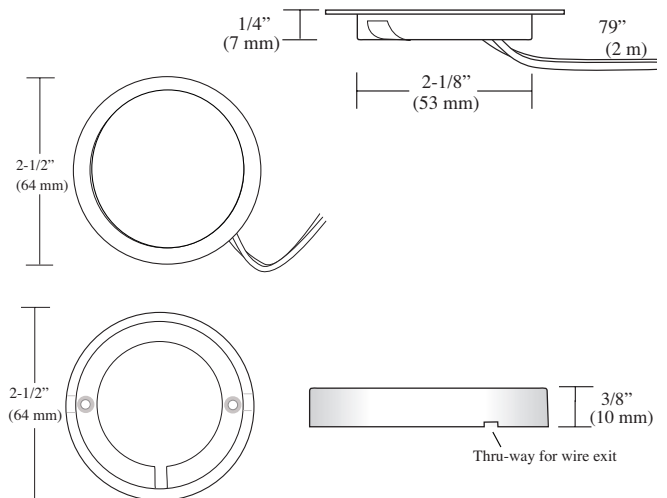

Available in multiple finishes with milk lens



Recess or surface mount

Typical Setup:

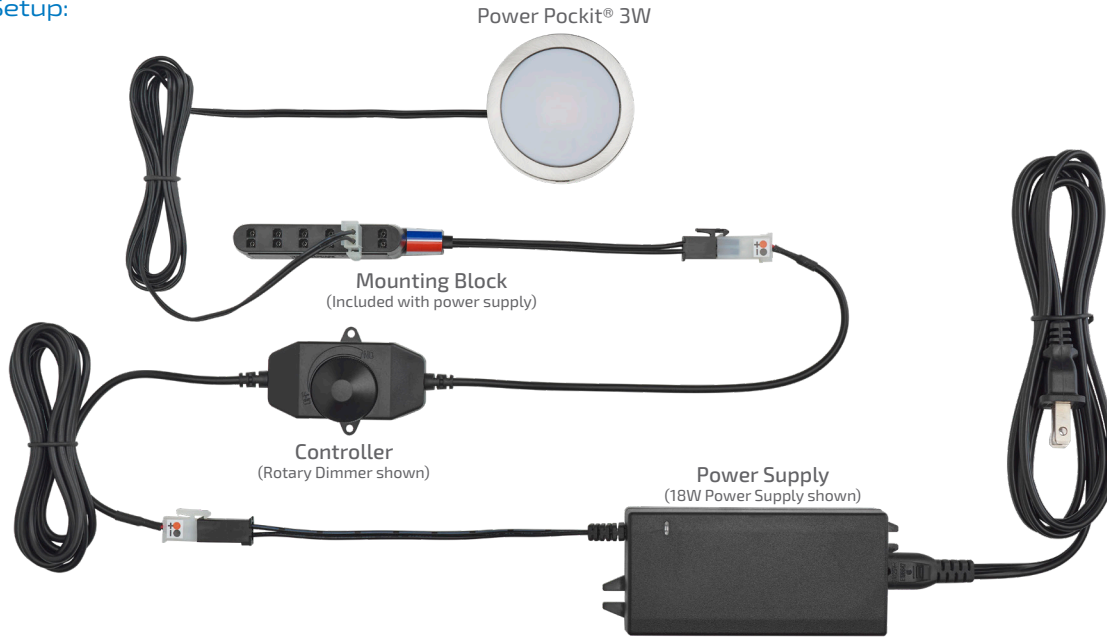

- Required
- Optional

Accessories:



**Power Supplies**  
see power supply section

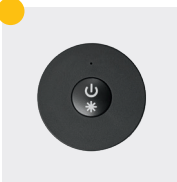

**Controllers**  
see controller section

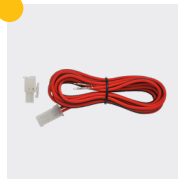

**Starter Cord / Link Cords**  
L-LED-LINKD-8-1  
L-LED-LINKD-15-1  
L-LED-LINKD-25-1  
L-LED-LINKD-60-1  
L-LED-LINKD-120-1  
L-LED-LINKD-180-1  
L-LED-LINKD-245-1

Specifications:

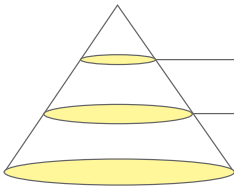
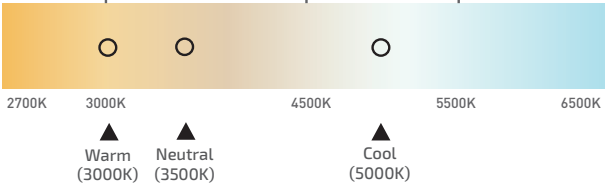
Wattage	Lumens	Efficacy (lm/W)	Input Voltage	Diode Life	Max Per 60W Power Supply	Mounting	Warranty	Beam Angle
3W	234	78	12VDC	50,000 Hours	20 Fixtures	Recess/ Surface	5 Year	
Photometric Data					Color Temperature			
		<b>Height</b>	<b>Light Output</b>	<b>Beam Area</b>	<div style="display: flex; justify-content: space-between;"> <span>Warm White</span> <span>Warm to Neutral</span> <span>Cool White</span> <span>Daylight</span> </div>  <div style="display: flex; justify-content: space-around; margin-top: 5px;"> <span>▲ Warm (3000K)</span> <span>▲ Neutral (3500K)</span> <span>▲ Cool (5000K)</span> </div>			
		1ft (.3 m)	81.30Fc (875.1lx)	3.1ft L x 3.1ft W (1 m L x 1 m W)				
		3ft (.9 m)	9.03Fc (97.2lx)	9.2ft L x 9.2ft W (2.8 m L x 2.8 m W)				
6ft (1.8 m)	2.26Fc (24.3lx)	18.4ft L x 18.4ft W (5.6 m L x 5.6 m W)						
L-POC-3LEDSFR-C Tested								

See page 40 for part numbers and descriptions

# Power Pockit® 5W

12VDC



<b>5W</b>	<b>500 Lumens</b>	<b>100°</b>
<p>The next generation of Power Pockit® is an astounding 25% more output than our original industry leading 3W version. With Luniform technology, 290 lumens of light are evenly distributed and eliminate the "dotted" appearance on surfaces. At only 1/4" (6 mm) depth, the Power Pockit® 5W has the the maximum illumination required in a small package.</p>		

### Features:

Slim Profile – 1/4" (7 mm)

Wide 100° beam spread

High output (290 lumens)

Luniform output – no "dots"

Durable milled aluminum construction

Recess or surface mount

### Typical Applications:

Displays or store furniture

Task or flood lighting

Interior cabinets/shelving

Under cabinets



Thin profile: Just 1/4" (7 mm) depth when recessing  
3/8" (10 mm) when surface mounting



### Available Finishes:

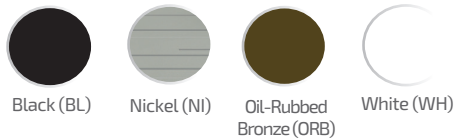

### Dimensions:

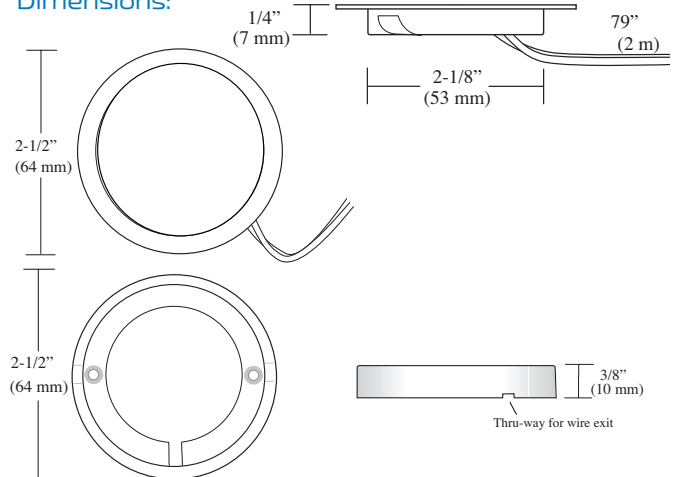

Available in multiple finishes with clear lens



Recess or surface mount

Typical Setup:

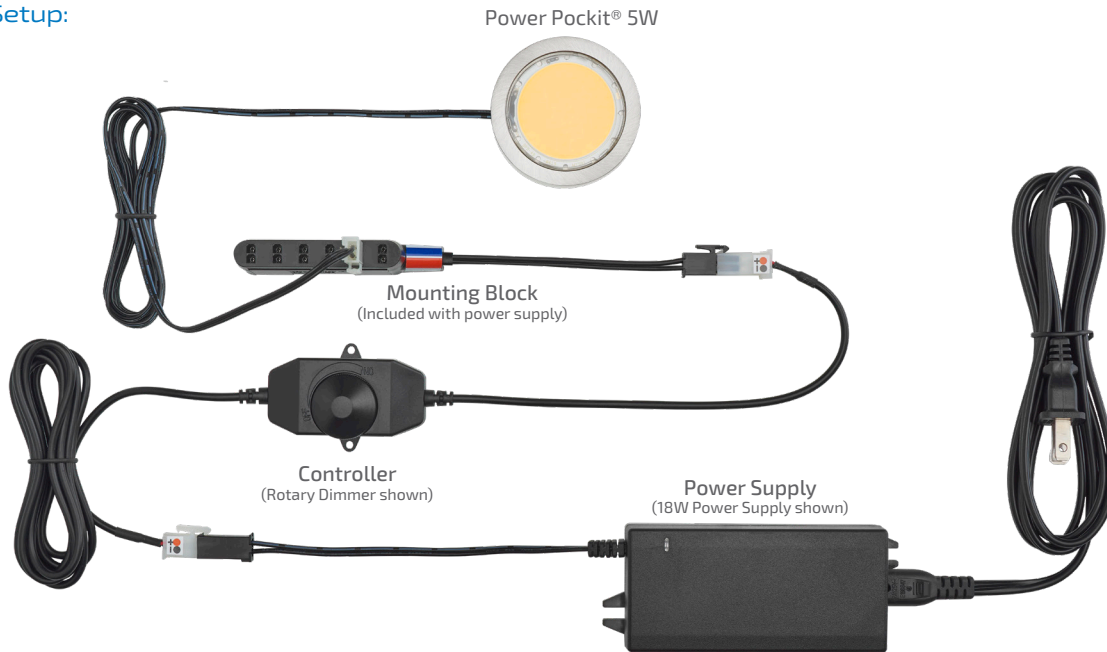

- Required
- Optional

Accessories:

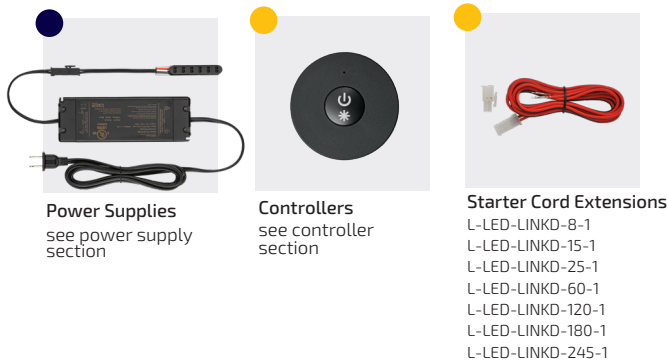

**Power Supplies**  
see power supply section

**Controllers**  
see controller section

**Starter Cord Extensions**  
 L-LED-LINKD-8-1  
 L-LED-LINKD-15-1  
 L-LED-LINKD-25-1  
 L-LED-LINKD-60-1  
 L-LED-LINKD-120-1  
 L-LED-LINKD-180-1  
 L-LED-LINKD-245-1

Specifications:

Wattage	Lumens	Efficacy (lm/W)	Input Voltage	Diode Life	Max Per 60W Power Supply	Mounting	Warranty	Beam Angle										
5W	290	58	12VDC	50,000 Hours	12 Fixtures	Recess/ Surface	5 Year											
Photometric Data					Color Temperature													
		<table border="1"> <thead> <tr> <th>Height</th> <th>Light Output</th> <th>Beam Area</th> </tr> </thead> <tbody> <tr> <td>1ft (.3 m)</td> <td>115.90Fc (1247.5lx)</td> <td>2.4ft L x 2.5ft W (.73 m L x .76 m W)</td> </tr> <tr> <td>3ft (.9 m)</td> <td>12.88Fc (138.6lx)</td> <td>7.3ft L x 7.4ft W (2.2 m L x 2.3 m W)</td> </tr> <tr> <td>6ft (1.8 m)</td> <td>3.22Fc (34.7lx)</td> <td>14.6ft L x 14.8ft W (4.5 m L x 4.5 m W)</td> </tr> </tbody> </table>	Height	Light Output	Beam Area	1ft (.3 m)	115.90Fc (1247.5lx)	2.4ft L x 2.5ft W (.73 m L x .76 m W)	3ft (.9 m)	12.88Fc (138.6lx)	7.3ft L x 7.4ft W (2.2 m L x 2.3 m W)	6ft (1.8 m)	3.22Fc (34.7lx)	14.6ft L x 14.8ft W (4.5 m L x 4.5 m W)				
Height	Light Output	Beam Area																
1ft (.3 m)	115.90Fc (1247.5lx)	2.4ft L x 2.5ft W (.73 m L x .76 m W)																
3ft (.9 m)	12.88Fc (138.6lx)	7.3ft L x 7.4ft W (2.2 m L x 2.3 m W)																
6ft (1.8 m)	3.22Fc (34.7lx)	14.6ft L x 14.8ft W (4.5 m L x 4.5 m W)																
L-POC-5LED-C Tested																		

See page 40 for part numbers and descriptions

# Pockit® Point

12VDC

1W

69 Lumens



1W Pockit® Point is the smallest LED spotlight on the market. Its small diameter and focused light are perfect for highlighting items in tight spaces.

The Pockit® Point features a very low profile with a recess depth of only 1/2" (13 mm), a collar spring for quick recessing and a 79" (2 m) starter cord attached with a loose AMP® connector for easier wire routing.



### Features:

1" (25 mm) recess diameter, 1/2" (13 mm) recess depth

90° beam spread

Nearly 70 lumens of output

Spring clip mounted

Recess mount

### Typical Applications:

Displays or store fixtures

Museum cases

Accent lighting

Interior cabinets and shelving

Small light boxes

Closets (UL listed for use within closet storage spaces)



Tiny 1" (25 mm) recessed diameter



### Available Finishes:

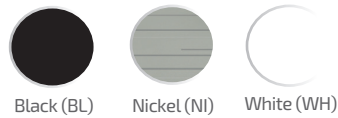

### Dimensions:

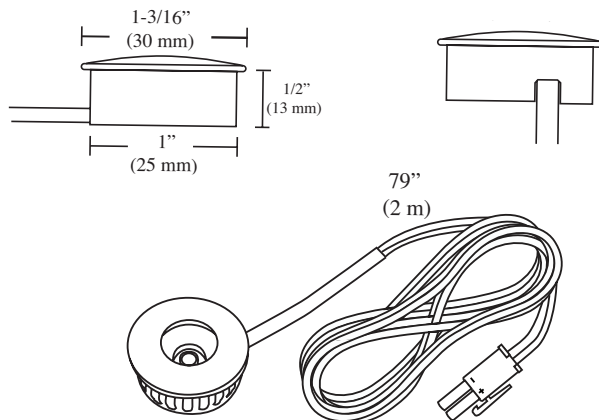

Available in 3 finishes



1-3/16" (30 mm) overall diameter

Typical Setup:

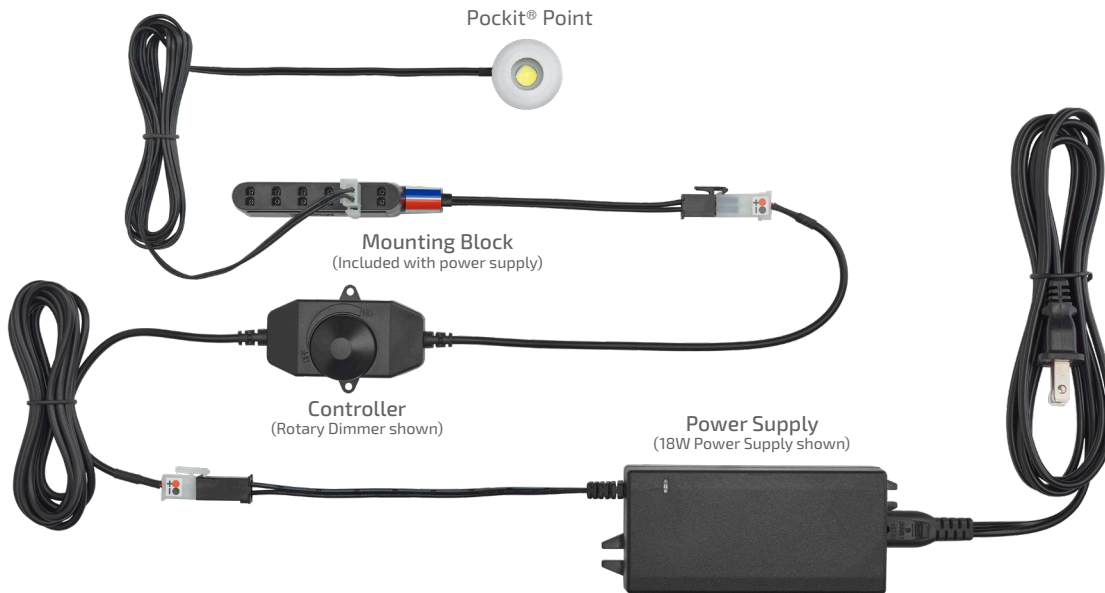

- Required
- Optional

Accessories:



**Power Supplies**  
see power supply section

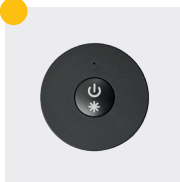

**Controllers**  
see controller section

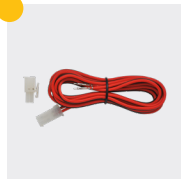

**Starter Cord Extensions**  
L-LED-LINKD-8-1  
L-LED-LINKD-15-1  
L-LED-LINKD-25-1  
L-LED-LINKD-60-1  
L-LED-LINKD-120-1  
L-LED-LINKD-180-1  
L-LED-LINKD-245-1

Specifications:

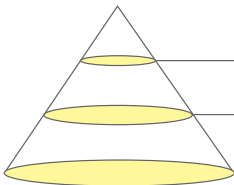
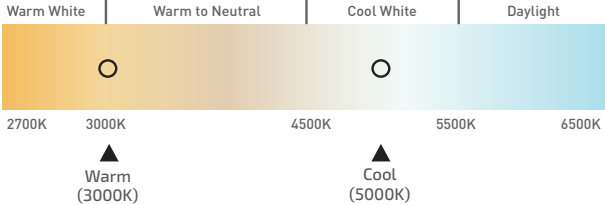
Wattage	Lumens	Efficacy (lm/W)	Input Voltage	Diode Life	Max Per 60W Power Supply	Mounting	Warranty	Beam Angle										
1W	69	69	12VDC	30,000 Hours	50 Fixtures	Recess	1 Year											
Photometric Data					Color Temperature													
		<table border="1"> <thead> <tr> <th>Height</th> <th>Light Output</th> <th>Beam Area</th> </tr> </thead> <tbody> <tr> <td>1ft (.3 m)</td> <td>37.60Fc (404.7lx)</td> <td>19ft L x 1.9ft W (.58 m L x .58 m W)</td> </tr> <tr> <td>3ft (.9 m)</td> <td>4.18Fc (45lx)</td> <td>5.8ft L x 5.8ft W (1.8 m L x 1.8 m W)</td> </tr> <tr> <td>6ft (1.8 m)</td> <td>1.04Fc (11.2lx)</td> <td>11.6ft L x 11.5ft W (3.5 m L x 3.5 m W)</td> </tr> </tbody> </table>	Height	Light Output	Beam Area	1ft (.3 m)	37.60Fc (404.7lx)	19ft L x 1.9ft W (.58 m L x .58 m W)	3ft (.9 m)	4.18Fc (45lx)	5.8ft L x 5.8ft W (1.8 m L x 1.8 m W)	6ft (1.8 m)	1.04Fc (11.2lx)	11.6ft L x 11.5ft W (3.5 m L x 3.5 m W)				
Height	Light Output	Beam Area																
1ft (.3 m)	37.60Fc (404.7lx)	19ft L x 1.9ft W (.58 m L x .58 m W)																
3ft (.9 m)	4.18Fc (45lx)	5.8ft L x 5.8ft W (1.8 m L x 1.8 m W)																
6ft (1.8 m)	1.04Fc (11.2lx)	11.6ft L x 11.5ft W (3.5 m L x 3.5 m W)																
L-LED-1EB-C Tested																		

See page 41 for part numbers and descriptions



# Pockit<sup>®</sup> Spot

12VDC

3W

298 Lumens



The 3W Pockit<sup>®</sup> Spot performs like a spotlight with a high focus output beam to keep countertops, kiosks and displays center stage. The fixture features an exceptionally low profile and two large springs for recess mounting in a depth of only 1-1/8" (29 mm). The 3W Pockit<sup>®</sup> Spot has the ability to swivel in either direction.

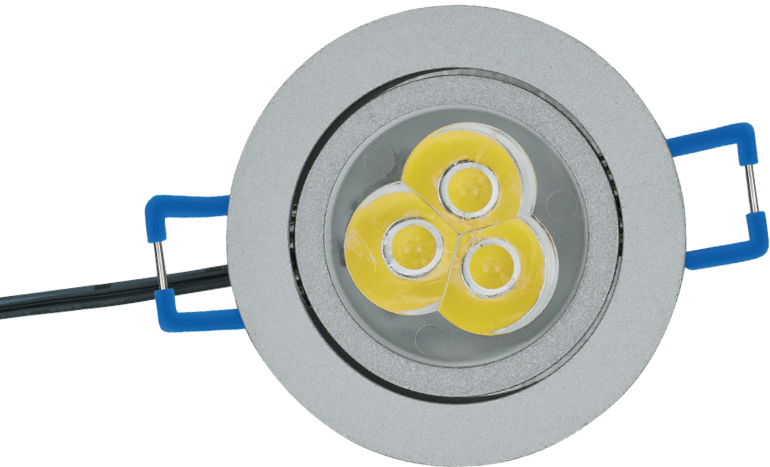

### Features:

Compact 1-1/8" (29 mm) depth

Focused 30° beam spread with 12° of swivel

Extremely efficient at approximately 100 lumens per watt

All metal construction

Recess mount

### Typical Applications:

Kiosks

Displays or store fixtures

Murphy beds

Elevators



Focused 30° beam spread



### Available Finishes:



Black (BL)



Nickel (NI)

### Dimensions:



Available in black or nickel



Spotlight your collectibles without the worry of heat or UV damage

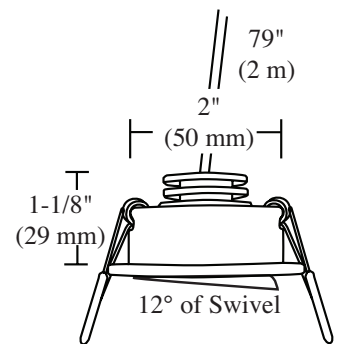
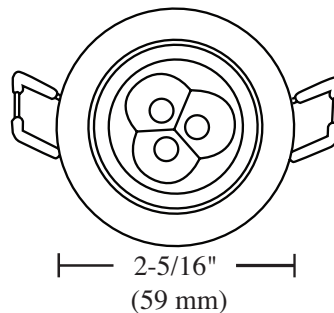

Typical Setup:

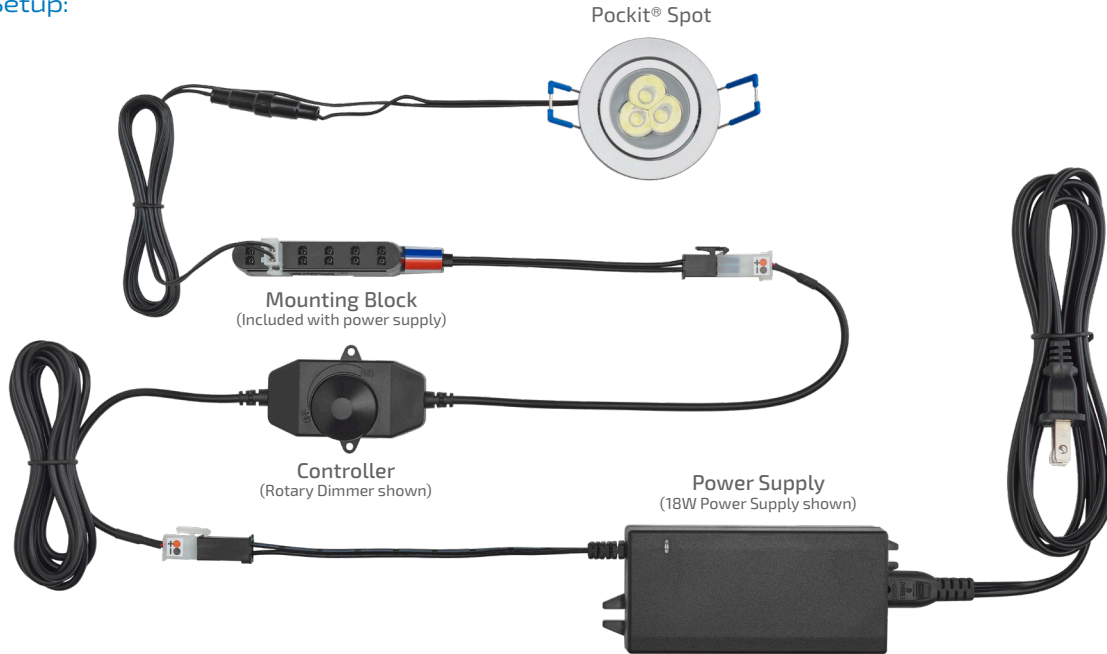

- Required
- Optional

Accessories:



**Power Supplies**  
see power supply section

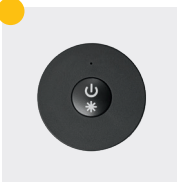

**Controllers**  
see controller section

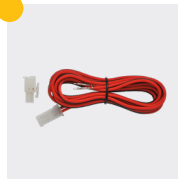

**Starter Cord Extensions**  
L-LED-LINKD-8-1  
L-LED-LINKD-15-1  
L-LED-LINKD-25-1  
L-LED-LINKD-60-1  
L-LED-LINKD-120-1  
L-LED-LINKD-180-1  
L-LED-LINKD-245-1

Specifications:

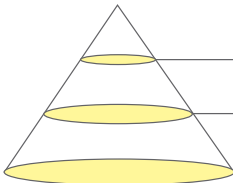
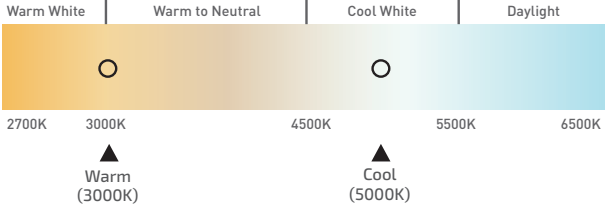
Wattage	Lumens	Efficacy (lm/W)	Input Voltage	Diode Life	Max Per 60W Power Supply	Mounting	Warranty	Beam Angle												
3W	298	99	12VDC	50,000 Hours	20 Fixtures	Recess	5 Year													
Photometric Data					Color Temperature															
 <table border="1"> <thead> <tr> <th>Height</th> <th>Light Output</th> <th>Beam Area</th> </tr> </thead> <tbody> <tr> <td>1ft (.3 m)</td> <td>1,134Fc (12217.0lx)</td> <td>4ft L x .4ft W (.12 m L x .12 m W)</td> </tr> <tr> <td>3ft (.9 m)</td> <td>126Fc (1356.3lx)</td> <td>1.3ft L x 1.3ft W (.4 m L x .4 m W)</td> </tr> <tr> <td>6ft (1.8 m)</td> <td>31.5Fc (339.1lx)</td> <td>2.6ft L x 2.6ft W (.79 m L x .79 m W)</td> </tr> </tbody> </table> <p>L-LED-3DSP-C Tested</p>					Height	Light Output	Beam Area	1ft (.3 m)	1,134Fc (12217.0lx)	4ft L x .4ft W (.12 m L x .12 m W)	3ft (.9 m)	126Fc (1356.3lx)	1.3ft L x 1.3ft W (.4 m L x .4 m W)	6ft (1.8 m)	31.5Fc (339.1lx)	2.6ft L x 2.6ft W (.79 m L x .79 m W)	 <p>Warm White   Warm to Neutral   Cool White   Daylight</p> <p>2700K 3000K 4500K 5500K 6500K</p> <p>▲ Warm (3000K)      ▲ Cool (5000K)</p>			
Height	Light Output	Beam Area																		
1ft (.3 m)	1,134Fc (12217.0lx)	4ft L x .4ft W (.12 m L x .12 m W)																		
3ft (.9 m)	126Fc (1356.3lx)	1.3ft L x 1.3ft W (.4 m L x .4 m W)																		
6ft (1.8 m)	31.5Fc (339.1lx)	2.6ft L x 2.6ft W (.79 m L x .79 m W)																		

See page 41 for part numbers and descriptions



# Pockit<sup>®</sup> Adapt

12VDC



5W	250 Lumens	
<p>As the name suggests, this Pockit<sup>®</sup> is adaptable to specific applications using one of three included lenses. Whether your application calls for a narrow or wide angle spot, only a simple change of the lens is needed. The 5/8" (16 mm) depth makes this one of the lowest profile spotlights in the industry while generating a staggering 250 lumen output.</p>		

### Features:

3 beam-angle changing lenses included: 25°, 45°, 60°

High output (250 lumens)

Aluminum die cast construction

Recess or surface mount – minimal 5/8" (16 mm) depth

### Typical Applications:

Kiosks and displays

Flyovers

Cabinets and soffits

Murphy beds

Elevators

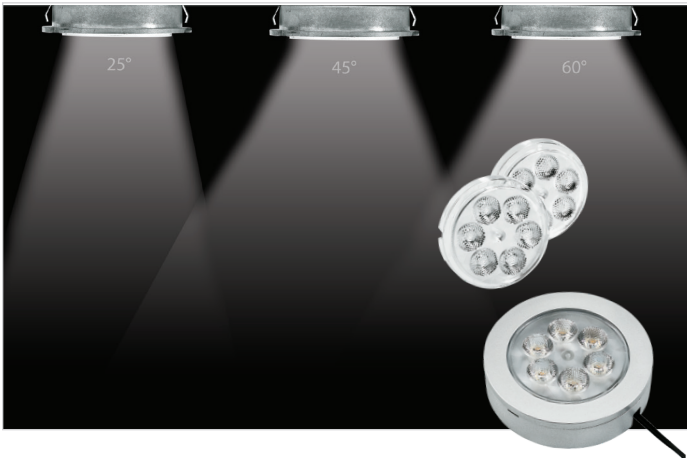

3 beam-angle changing lenses included



### Available Finishes:



### Dimensions:

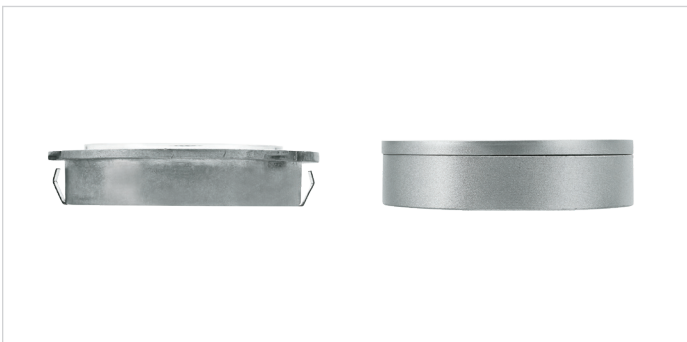
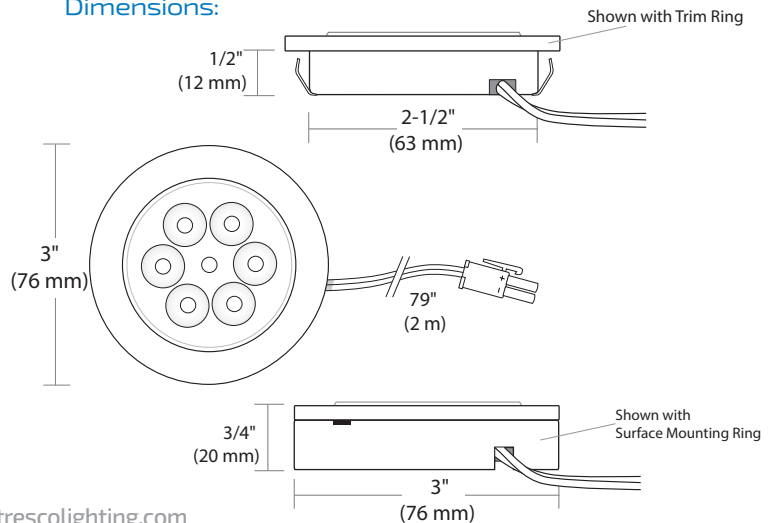

Recess or surface mount

Typical Setup:

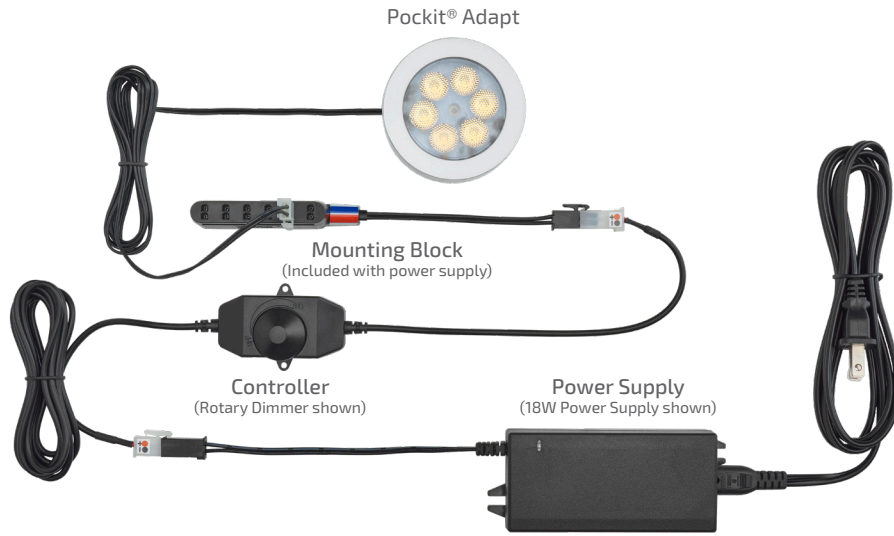

- Required
- Optional

Accessories:



**Power Supplies**  
see power supply section



**Pockit® Adapt Trim Kit**  
L-ADJTKIT-BL-1  
L-ADJTKIT-NI-1  
L-ADJTKIT-WH-1

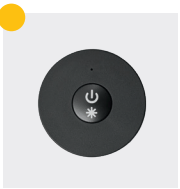

**Controllers**  
see controller section



**Starter Cord Extensions**  
L-LED-LINKD-8-1  
L-LED-LINKD-15-1  
L-LED-LINKD-25-1  
L-LED-LINKD-60-1  
L-LED-LINKD-120-1  
L-LED-LINKD-180-1  
L-LED-LINKD-245-1

Specifications:

Wattage	Lumens	Efficacy (lm/W)	Input Voltage	Diode Life	Max Per 60W Power Supply	Mounting	Warranty	Beam Angle
5W	250	50	12VDC	50,000 Hours	12 Fixtures	Recess/ Surface	5 Year	

Photometric Data

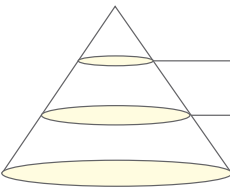
	Height	Light Output (60° Lens)	Light Output (45° Lens)	Light Output (25° Lens)	Beam Area (60° Lens)	Beam Area (45° Lens)	Beam Area (25° Lens)
	1ft (.3 m)	201.20Fc (2165.70lx)	456.80Fc (4916.95lx)	854.00Fc (9192.38lx)	1.1ft L x 1.1ft W (.34 m L x .34 m W)	.7ft L x .7ft W (.21 m L x .21 m W)	.5ft L x .5ft W (.15 m L x .15 m W)
	3ft (.9 m)	22.36Fc (240.68lx)	50.76Fc (546.38lx)	94.89Fc (1021.39lx)	3.4ft L x 3.3ft W (1 m L x 1 m W)	2ft L x 2ft W (.61 m L x .61 m W)	1.4ft L x 1.4ft W (.43 m L x .43 m W)
	6ft (1.8 m)	5.59Fc (60.17lx)	12.69Fc (136.59lx)	23.72Fc (255.32lx)	6.8ft L x 6.7ft W (2.1 m L x 2 m W)	4ft L x 4ft W (1.22 m L x 1.22 m W)	2.8ft L x 2.8ft W (.85 m L x .85 m W)

L-POC-5ADJ-C Tested

Color Temperature

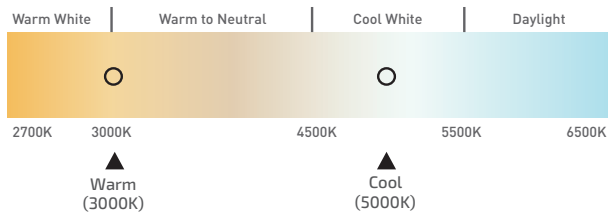

See page 41 for part numbers and descriptions

Economy Series

12VDC

# 3W EquiLine Puck

3W

218 Lumens

100°

With recessed or surface mount ability, EquiLine LED Pucks are perfect for use in a wide range of applications. Designed for the economically conscious, they feature a slim profile and a 79" (2 m) starter cord attached with an unattached AMP® connector for easy wire routing.



### Features:

1/2" (13 mm) recessed depth

100° beam spread

Luniform output – no "dots"

Metal heatsink for cool operation

Recess or surface mount

### Typical Applications:

Furniture

Desk

Headboards

Cabinets and light boxes

Closets (UL listed for use within closet storage spaces)



Slim 1/2" (13 mm) recess profile



### Available Finishes:



Black (BL)



Nickel (NI)

### Dimensions:

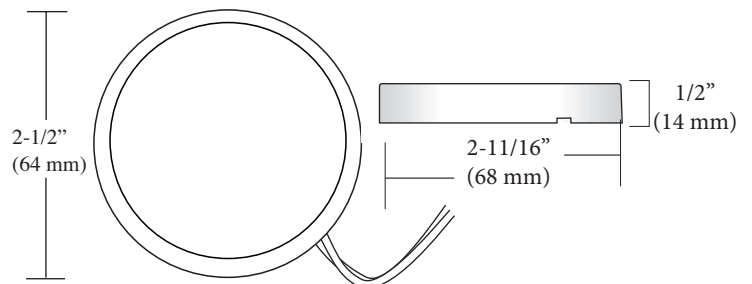
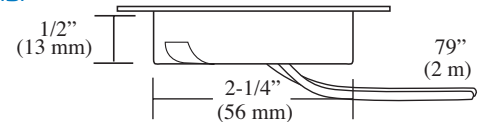

Available in Black or Nickel



Surface mount ring sold separately

Typical Setup:



- Required
- Optional

Accessories:



**Power Supplies**  
see power supply section

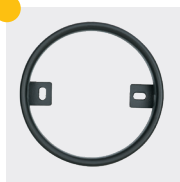

**EquiLine Puck Surface Ring**  
L-SMR-2LED-BL-1  
L-SMR-2LED-NI-1

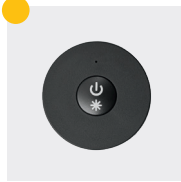

**Controllers**  
see controller section

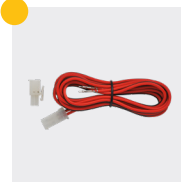

**Starter Cord Extensions**  
L-LED-LINKD-8-1  
L-LED-LINKD-15-1  
L-LED-LINKD-25-1  
L-LED-LINKD-60-1  
L-LED-LINKD-120-1  
L-LED-LINKD-180-1  
L-LED-LINKD-245-1

Specifications:

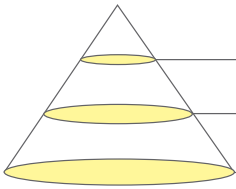
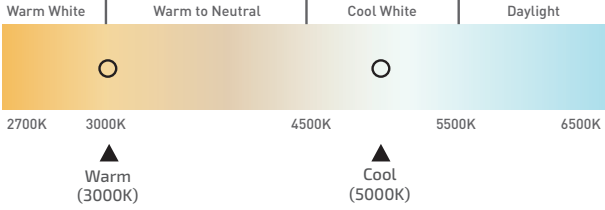
Wattage	Lumens	Efficacy (lm/W)	Input Voltage	Diode Life	Max Per 60W Power Supply	Mounting	Warranty	Beam Angle												
3W	218	73	12VDC	25,000 Hours	20 Fixtures	Recess/ Surface	2 Year													
Photometric Data					Color Temperature															
 <table border="1" style="margin-left: auto; margin-right: auto;"> <thead> <tr> <th>Height</th> <th>Light Output</th> <th>Beam Area</th> </tr> </thead> <tbody> <tr> <td>1ft (.3 m)</td> <td>89.00Fc (958lx)</td> <td>2ft diameter (.6 m diameter)</td> </tr> <tr> <td>3ft (.9 m)</td> <td>9.89Fc (106.5lx)</td> <td>7ft diameter (2.1 m diameter)</td> </tr> <tr> <td>6ft (1.8 m)</td> <td>2.47Fc (26.6lx)</td> <td>14ft diameter (4.3 m diameter)</td> </tr> </tbody> </table> <p style="text-align: center; font-size: small;">L-POC-3EQFR-C Tested</p>					Height	Light Output	Beam Area	1ft (.3 m)	89.00Fc (958lx)	2ft diameter (.6 m diameter)	3ft (.9 m)	9.89Fc (106.5lx)	7ft diameter (2.1 m diameter)	6ft (1.8 m)	2.47Fc (26.6lx)	14ft diameter (4.3 m diameter)	 <p style="text-align: center; font-size: small;"> <span>Warm White</span>   <span>Warm to Neutral</span>   <span>Cool White</span>   <span>Daylight</span>                  2700K 3000K 4500K 5500K 6500K                  ▲ Warm (3000K)      ▲ Cool (5000K)             </p>			
Height	Light Output	Beam Area																		
1ft (.3 m)	89.00Fc (958lx)	2ft diameter (.6 m diameter)																		
3ft (.9 m)	9.89Fc (106.5lx)	7ft diameter (2.1 m diameter)																		
6ft (1.8 m)	2.47Fc (26.6lx)	14ft diameter (4.3 m diameter)																		

See page 42 for part numbers and descriptions

# Pocket® 120-M

120V



Linkable up to 45 fixtures



True plug-and-play: no transformer or power supply required



Recess or surface mount (ring included)

4W	270 Lumens	
<p>The Pocket® 120-M is the next generation of our popular Pocket® 120 linkable series. Featuring a smaller size, each fixture has a built-in dimmable driver and the commercial grade, all-metal construction provides optimal heatsinking with more than double the light output of the original Pocket® 120-L. No external power supply needed, just plug in and start linking away!</p>		

### Features:



- High output (270 lumens)
- Lunifrom output – no “dots”
- Dimmable to 50% by standard LED wall dimmers
- Linkable up to 45 fixtures
- No power supply required
- Die cast construction

### Typical Applications:

- Displays
- Task lighting/flood lighting
- Interior cabinets/shelving
- Under cabinets



### Available Finishes:

-  Black (BL)
-  Nickel (NI)
-  White (WH)

### Dimensions:

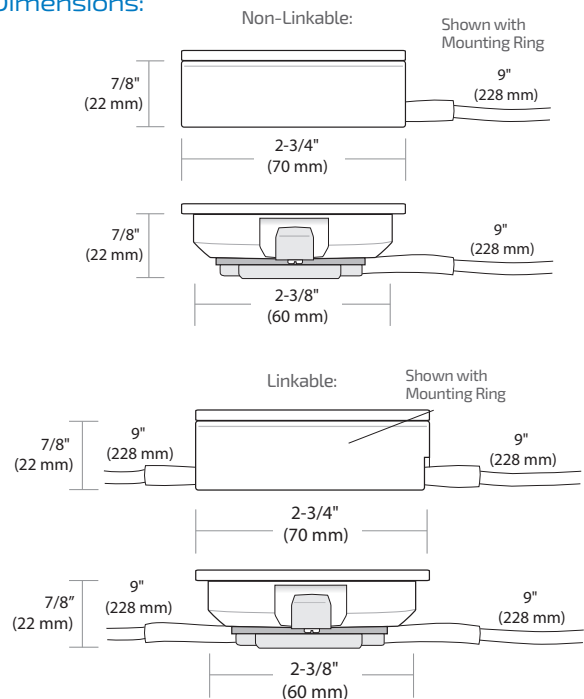

Typical Setup:

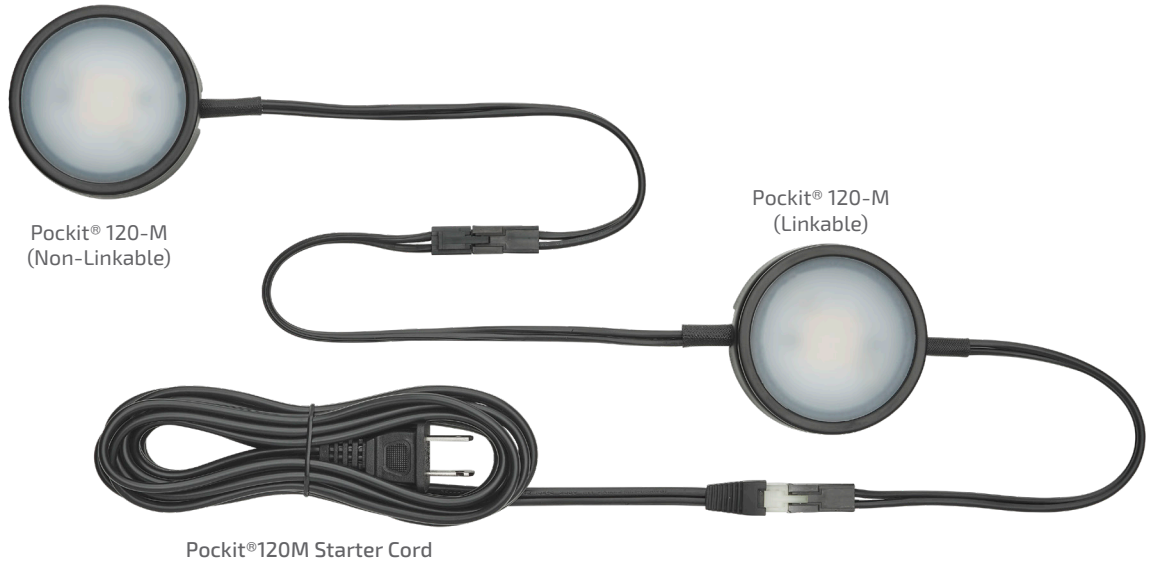

- Required
- Optional

Accessories:



**Pockit® 120-M Starter Cord**  
 L-MPOC-PKT8-BL-1  
 L-MPOC-PKT8-WH-1



**Link Cord/Extension**  
 L-FPOC-LINKA-25-BL-1  
 L-FPOC-LINKA-25-WH-1  
 L-FPOC-LINKA-60-BL-1  
 L-FPOC-LINKA-60-WH-1  
 L-FPOC-LINKA-120-BL-1  
 L-FPOC-LINKA-120-WH-1  
 L-FPOC-LINKA-180-BL-1  
 L-FPOC-LINKA-180-WH-1



**Round Switch - 120V**  
 L-RDSW-1M-120-BL-1  
 L-RDSW-1M-120-WH-1  
 L-RDSW-2M-120-BL-1  
 L-RDSW-2M-120-WH-1



**Hardwire Boxes**  
 L-HWB-BL-T5-1  
 L-HWB-WH-T5-1  
 L-HWB-BL-T5-S-1  
 L-HWB-WH-T5-S-1



**Pockit® 120-L/M Adaptor for Hardwire Box**  
 L-FPOC-HWB-ADP-BL-1  
 L-FPOC-HWB-ADP-WH-1

Specifications:

Dimmable up to 50%

Wattage	Lumens	Efficacy (lm/W)	Input Voltage	Diode Life	Max Continuous Run	Mounting	Warranty	Beam Angle												
4W	270	67.5	120V	30,000 Hours	45 Fixtures	Recess/ Surface	3 Year													
Photometric Data					Color Temperature															
<table border="1"> <thead> <tr> <th>Height</th> <th>Light Output</th> <th>Beam Area</th> </tr> </thead> <tbody> <tr> <td>1ft (3m)</td> <td>110.5Fc (1189.4lx)</td> <td>2.3ft L x 2.3ft W (.7 m L x .7 m W)</td> </tr> <tr> <td>3ft (9m)</td> <td>12.28Fc (132.2lx)</td> <td>6.9ft L x 6.9ft W (2.1 m L x 2.1 m W)</td> </tr> <tr> <td>6ft (1.8 m)</td> <td>3.07Fc (33.0lx)</td> <td>13.9ft L x 13.8ft W (4.2 m L x 4.2 m W)</td> </tr> </tbody> </table> <p>L-MPOC-4W-120NL-C Tested</p>					Height	Light Output	Beam Area	1ft (3m)	110.5Fc (1189.4lx)	2.3ft L x 2.3ft W (.7 m L x .7 m W)	3ft (9m)	12.28Fc (132.2lx)	6.9ft L x 6.9ft W (2.1 m L x 2.1 m W)	6ft (1.8 m)	3.07Fc (33.0lx)	13.9ft L x 13.8ft W (4.2 m L x 4.2 m W)	<p>Warm White   Warm to Neutral   Cool White   Daylight</p> <p>2700K 3000K 4500K 5500K 6500K</p> <p>▲ Warm (3000K)      ▲ Cool (5000K)</p>			
Height	Light Output	Beam Area																		
1ft (3m)	110.5Fc (1189.4lx)	2.3ft L x 2.3ft W (.7 m L x .7 m W)																		
3ft (9m)	12.28Fc (132.2lx)	6.9ft L x 6.9ft W (2.1 m L x 2.1 m W)																		
6ft (1.8 m)	3.07Fc (33.0lx)	13.9ft L x 13.8ft W (4.2 m L x 4.2 m W)																		

See page 43 for part numbers and descriptions



- Required
- Optional

● 12VDC 3W Power Pockit® Series

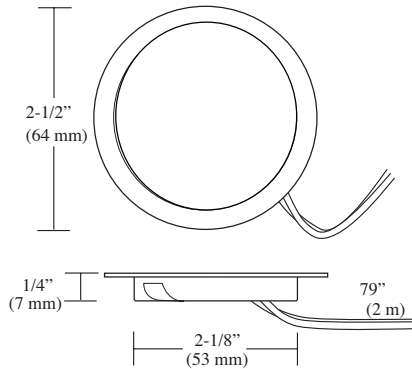

Part #	Description
L-POC-3LEDSFR-CAB-1	3W 5000K Antique Brass LED Pockit® Light
L-POC-3LEDSFR-CBL-1	3W 5000K Black LED Pockit® Light
L-POC-3LEDSFR-CCH-1	3W 5000K Chrome LED Pockit® Light
L-POC-3LEDSFR-CNI-1	3W 5000K Nickel LED Pockit® Light
L-POC-3LEDSFR-CWH-1	3W 5000K White LED Pockit® Light
L-POC-3LEDSFR-NNI-1	3W 3500K Nickel LED Pockit® Light
L-POC-3LEDSFR-NBL-1	3W 3500K Black LED Pockit® Light
L-POC-3LEDSFR-WAB-1	3W 3000K Antique Brass LED Pockit® Light
L-POC-3LEDSFR-WBL-1	3W 3000K Black LED Pockit® Light
L-POC-3LEDSFR-WCH-1	3W 3000K Chrome LED Pockit® Light
L-POC-3LEDSFR-WNI-1	3W 3000K Nickel LED Pockit® Light
L-POC-3LEDSFR-WORB-1	3W 3000K Oil-Rubbed Bronze LED Pockit® Light
L-POC-3LEDSFR-WWH-1	3W 3000K White LED Pockit® Light

Surface Mount Ring is included with each light.

2-1/4" (57 mm) hole required for recessed mounting; 1/4" (6 mm) recessed depth. Power Pockit® includes Surface Mount Ring, AMP® Connector, and 79" (2 m) of input lead.

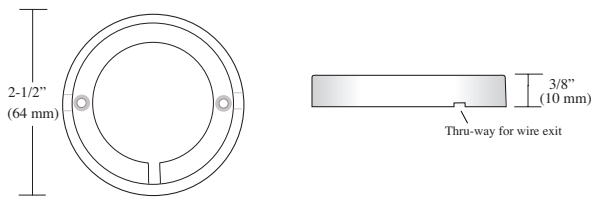

● 12VDC 5W Power Pockit®

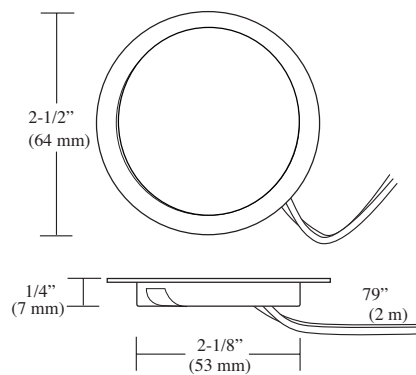

Part #	Description
L-POC-5LEDSCL-CBL-1	5W 5000K Black LED Pockit® Light
L-POC-5LEDSCL-CNI-1	5W 5000K Nickel LED Pockit® Light
L-POC-5LEDSCL-CWH-1	5W 5000K White LED Pockit® Light
L-POC-5LEDSCL-WBL-1	5W 3000K Black LED Pockit® Light
L-POC-5LEDSCL-WNI-1	5W 3000K Nickel LED Pockit® Light
L-POC-5LEDSCL-WORB-1	5W 3000K Oil-Rubbed Bronze LED Pockit® Light
L-POC-5LEDSCL-WWH-1	5W 3000K White LED Pockit® Light

Surface Mount Ring is included with each light.

2-1/4" (57 mm) hole required for recessed mounting; 1/4" (6 mm) recessed depth. Power Pockit® includes Surface Mount Ring, AMP® Connector, and 79" (2 m) input lead.

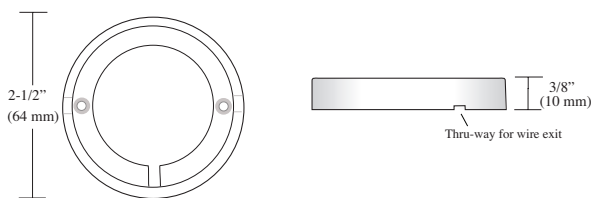

COMPONENTS: POWER SUPPLIES, CONTROLLERS AND MORE SEE PAGE 150.

● 12VDC Pockit® Point LED Series

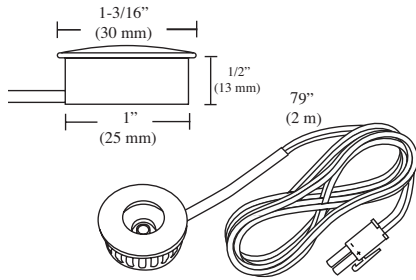

Part #	Description
L-LED-1EB-CBL-1	1W 12VDC Pockit® Point, 5000K, Black
L-LED-1EB-CNI-1	1W 12VDC Pockit® Point, 5000K, Nickel
L-LED-1EB-CWH-1	1W 12VDC Pockit® Point, 5000K, White
L-LED-1EB-WBL-1	1W 12VDC Pockit® Point, 3000K, Black
L-LED-1EB-WNI-1	1W 12VDC Pockit® Point, 3000K, Nickel
L-LED-1EB-WWH-1	1W 12VDC Pockit® Point, 3000K, White

1" (25 mm) hole required for recessed mounting; 7/16" (11 mm) recessed depth. Collar Spring, 79" (2 m) Starter Cord, and AMP® Connector are included with each light.

● 12VDC Pockit® Spot

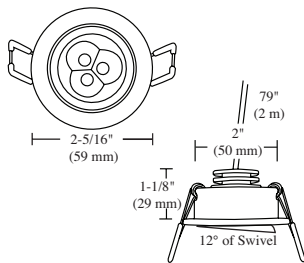

Part #	Description
L-LED-3DSP-CBL-1	3W 5000K Black Recess Pockit® Swivel Spot
L-LED-3DSP-CNI-1	3W 5000K Satin Nickel Recess Pockit® Swivel Spot
L-LED-3DSP-WBL-1	3W 3000K Black Recess Pockit® Swivel Spot
L-LED-3DSP-WNI-1	3W 3000K Satin Nickel Recess Pockit® Swivel Spot

2-1/8" (54 mm) hole required for recessed mounting; 1" (26 mm) recessed depth. Starter Cord 79" (2 m), and AMP® Connector are included with each light.

● 12VDC Pockit® Adapt

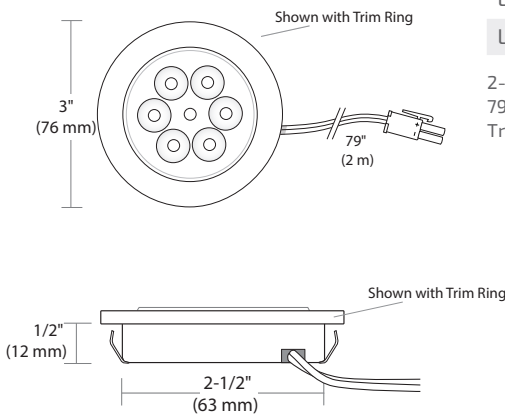

Part #	Description
L-POC-5ADJ-C-1	12VDC 5W Pockit® Adapt, 5000K
L-POC-5ADJ-W-1	12VDC 5W Pockit® Adapt, 3000K

2-5/8" (67 mm) hole required for recessed mounting; 5/8" (16 mm) recessed depth. 79" (2 m) Starter Cord, and AMP® Connector are included with each light. Trim kit purchased separately.

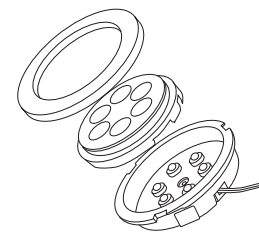

● 12VDC Pockit® Adapt Trim Kit

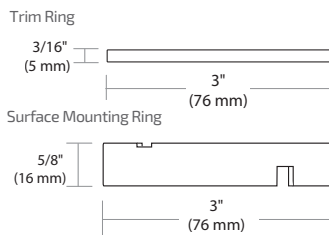

Part #	Description
L-ADJTKIT-BL-1	Pockit® Adapt Trim Kit, Black
L-ADJTKIT-NI-1	Pockit® Adapt Trim Kit, Nickel
L-ADJTKIT-WH-1	Pockit® Adapt Trim Kit, White



COMPONENTS: POWER SUPPLIES, CONTROLLERS AND MORE SEE PAGE 150.

## ● 12VDC EquiLine Puck Light

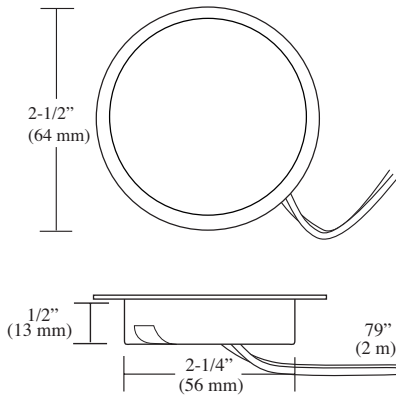

Part #	Description
L-POC-3EQFR-CBL-1	3W EquiLine Puck 5000K, Black
L-POC-3EQFR-CNI-1	3W EquiLine Puck 5000K, Nickel
L-POC-3EQFR-WBL-1	3W EquiLine Puck 3000K, Black
L-POC-3EQFR-WNI-1	3W EquiLine Puck 3000K, Nickel

2-1/4" (57 mm) hole required for recessed mounting; 1/2" (13 mm) recessed depth. EquiLine includes starter cord 79" (2 m) and AMP® Connector with each light. Surface mount ring sold separately.

## ● 12VDC EquiLine Puck Surface Ring

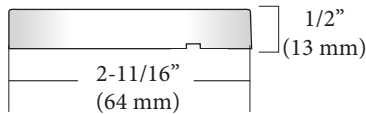

Part #	Description
L-SMR-2LED-BL-1	EquiLine Puck Surface Ring Black
L-SMR-2LED-NI-1	EquiLine Puck Surface Ring Nickel

## ● 12VDC Power Supplies



Part #	Description
L-DC-SLELT30-1	30W 12VDC Power Supply w/6 Snap Mounting Block*
L-DC-SLELT60-1	60W 12VDC Power Supply w/6 Snap Mounting Block*
L-DC-ELT6WP-CON-1	6W 12VDC Wall Mount Power Supply w/3 Snap Block*
L-DC-ELT15WP-CON-1	15W 12VDC Wall Mount Power Supply w/6 Snap Block*
L-DC-EQ30-1	30W 12VDC Equiline Power Supply w/6 Snap Block*
L-DC-EQ60-1	60W 12VDC Equiline Power Supply w/6 Snap Block*
L-DCE30D-CON-1	30W 12VDC Hardwire Dimmable LED Power Supply†
L-DCE60D-CON-1	60W 12VDC Hardwire Dimmable LED Power Supply†
L-12DCH60X1-1	60W 12VDC Commercial/Industrial Metal Hardwire Dimmable Power Supply‡
L-12DCH60X3-1	180W 12VDC Commercial/Industrial Metal Hardwire Dimmable Power Supply‡
L-12DCH60X5-120-277V-1	300W 12VDC Commercial Hardwire 0-10V Dimmable Power Supply

\* Dimmable on trailing edge (12VDC side). Mounting block and power cord are included.

† Dimmable by LED line voltage (120V) wall dimmers. Mounting block included.

‡ Dimmable by LED line voltage (120V) wall dimmers. Mounting block not included.

All hardwire power supplies require an electrician for install.



**COMPONENTS: POWER SUPPLIES, CONTROLLERS AND MORE SEE PAGE 150.**

● 12VDC Starter Cord Extensions

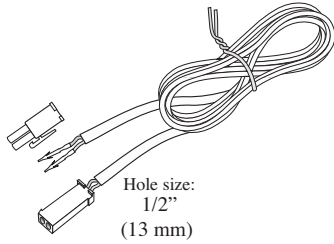

Part #	Description
L-LED-LINKD-8-1	8 cm (3") 12VDC Starter/Link/Extension Cord
L-LED-LINKD-15-1	15 cm (6") 12VDC Starter/Link/Extension Cord
L-LED-LINKD-25-1	25 cm (10") 12VDC Starter/Link/Extension Cord
L-LED-LINKD-60-1	60 cm (24") 12VDC Starter/Link/Extension Cord
L-LED-LINKD-120-1	120 cm (48") 12VDC Starter/Link/Extension Cord
L-LED-LINKD-180-1	180 cm (72") 12VDC Starter/Link/Extension Cord
L-LED-LINKD-245-1	245 cm (96") 12VDC Starter/Link/Extension Cord

● 120V Pockit® 120-M-Non-Linkable

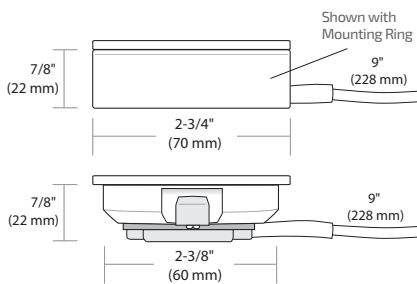

Part #	Description
L-MPOC-4W-120NL-CBL-1	120V Pockit® 120-M Non-Linkable, Cool, Black
L-MPOC-4W-120NL-CNI-1	120V Pockit® 120-M Non-Linkable, Cool, Nickel
L-MPOC-4W-120NL-CWH-1	120V Pockit® 120-M Non-Linkable, Cool, White
L-MPOC-4W-120NL-WBL-1	120V Pockit® 120-M Non-Linkable, Warm, Black
L-MPOC-4W-120NL-WNI-1	120V Pockit® 120-M Non-Linkable, Warm, Nickel
L-MPOC-4W-120NL-WWH-1	120V Pockit® 120-M Non-Linkable, Warm, White

2-3/8" (60 mm) hole required for recessing.  
Surface mount ring included with each light.  
Dimmable to 50% by standard LED wall dimmers.

● 120V Pockit® 120-M-Linkable

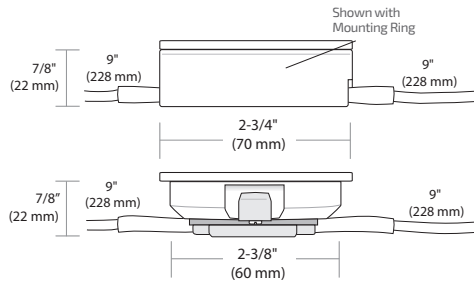

Part #	Description
L-MPOC-4W-120L-CBL-1	120V Pockit® 120-M Linkable, Cool, Black
L-MPOC-4W-120L-CNI-1	120V Pockit® 120-M Linkable, Cool, Nickel
L-MPOC-4W-120L-CWH-1	120V Pockit® 120-M Linkable, Cool, White
L-MPOC-4W-120L-WBL-1	120V Pockit® 120-M Linkable, Warm, Black
L-MPOC-4W-120L-WNI-1	120V Pockit® 120-M Linkable, Warm, Nickel
L-MPOC-4W-120L-WWH-1	120V Pockit® 120-M Linkable, Warm, White

2-3/8" (60 mm) hole required for recessing.  
Surface mount ring included with each light.  
Dimmable to 50% by standard LED wall dimmers.

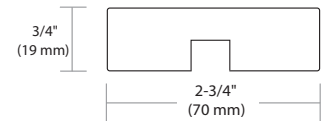

● 120V Pockit® 120-M Starter Cord

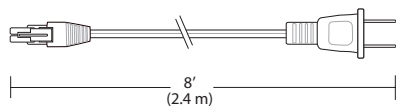

Part #	Description
L-MPOC-PKT8-BL-1	120V Pockit® 120-M, 8 ft. (2.4 m) Starter Cord, Black
L-MPOC-PKT8-WH-1	120V Pockit® 120-M, 8 ft. (2.4 m) Starter Cord, White



COMPONENTS: POWER SUPPLIES, CONTROLLERS AND MORE SEE PAGE 150.



● 120V Link Cord/Extension

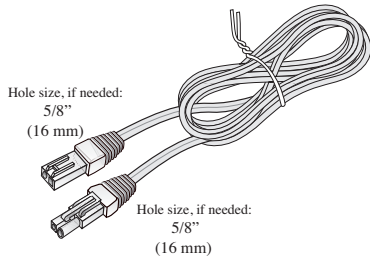

Part #	Description
L-FPOC-LINKA-25-BL-1	10" (25 cm) Black Pockit® 120-L/M Linking Cord
L-FPOC-LINKA-25-WH-1	10" (25 cm) White Pockit® 120-L/M Linking Cord
L-FPOC-LINKA-60-BL-1	24" (60 cm) Black Pockit® 120-L/M Linking Cord
L-FPOC-LINKA-60-WH-1	24" (60 cm) White Pockit® 120-L/M Linking Cord
L-FPOC-LINKA-120-BL-1	48" (120 cm) Black Pockit® 120-L/M Linking Cord
L-FPOC-LINKA-120-WH-1	48" (120 cm) White Pockit® 120-L/M Linking Cord
L-FPOC-LINKA-180-BL-1	72" (180 cm) Black Pockit® 120-L/M Linking Cord
L-FPOC-LINKA-180-WH-1	72" (180 cm) White Pockit® 120-L/M Linking Cord

● 120V Round Switch

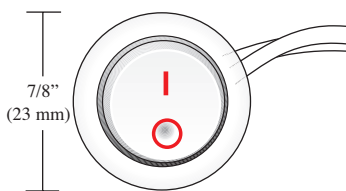

Part #	Description
L-RDSW-1M-120-BL-1	120V Black Round Rocker Switch w/ 39" (1 m) Lead
L-RDSW-1M-120-WH-1	120V White Round Rocker Switch w/ 39" (1 m) Lead
L-RDSW-2M-120-BL-1	120V Black Round Rocker Switch w/ 79" (2 m) Lead
L-RDSW-2M-120-WH-1	120V White Round Rocker Switch w/ 79" (2 m) Lead

3/4" (19 mm) hole required.

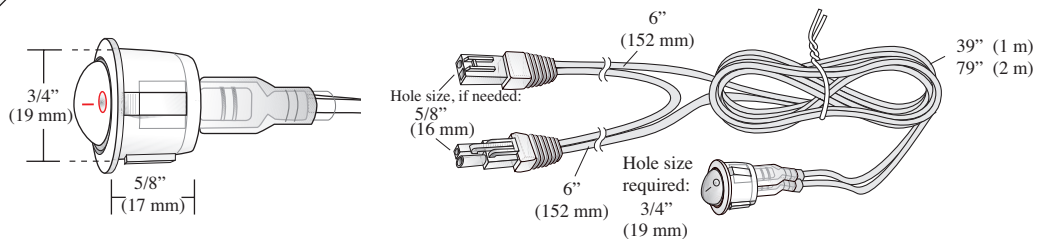

● 120V Hardwire Boxes

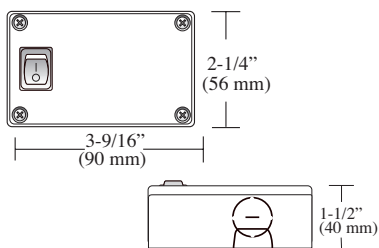

Part #	Description
L-HWB-BL-T5-1	T5 Black Hardwire Box, without Switch
L-HWB-WH-T5-1	T5 White Hardwire Box, without Switch
L-HWB-BL-T5-S-1	T5 Black Hardwire Box, with Switch
L-HWB-WH-T5-S-1	T5 White Hardwire Box, with Switch

Maximum (10) light fixtures per hardwire box.  
**Must use Pockit® 120L/M Adaptor.**



**COMPONENTS: POWER SUPPLIES, CONTROLLERS AND MORE SEE PAGE 150.**

● **120V Pockit® 120-L/M Adaptor for Hardwire Box**

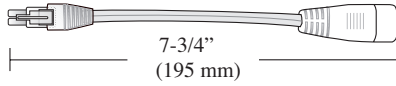

Part #	Description
L-FPOC-HWB-ADP-BL-1	Pockit® 120-M Adaptor for Hardwire Box, Black
L-FPOC-HWB-ADP-WH-1	Pockit® 120-M Adaptor for Hardwire Box, White

Required when using Hardwire Box.

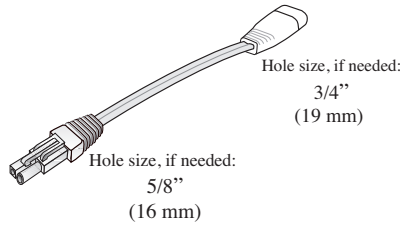

**NOTE: Must use hardwire box when used with a wall dimmer. Do not dim a receptacle.**

**How to Connect Using Hardwire Box:**

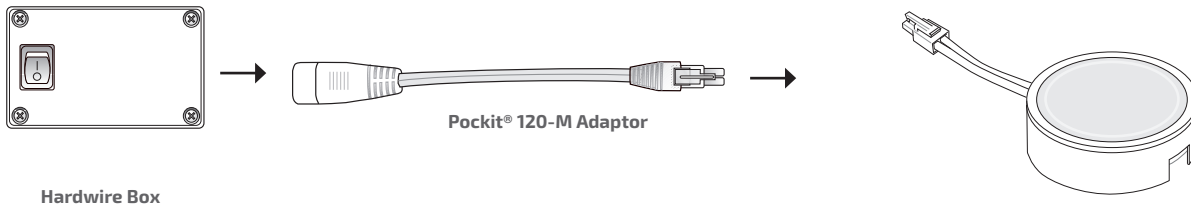

● **120V LED Wall Controllers**



Part #	Description
L-DVCL-153P-WH-1	Lutron Diva® C-L™ 150W Dimmer w/o Plate
L-CTCL-153P-WH-1	Lutron Skylark Contour C-L™ 150W Dimmer w/o Plate
L-DSL06-1LZ-1	Leviton Decora 300W LED Dimmer w/WH-IV-LA Kit

● **120V Wi-Fi Enabled LED Wall Controllers**

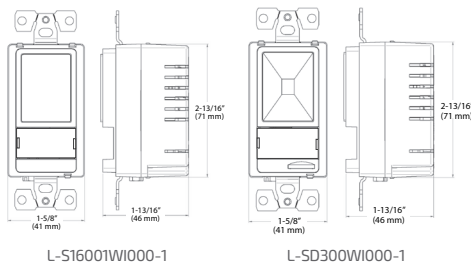

Part #	Description
L-S1600WI000-1	120VAC 300W/600W Swidget Toggle Switch w/ Wi-Fi Control Insert, White
L-SD300WI000-1	120VAC 150W/300W Swidget Dimmer Switch w/ Wi-Fi Control Insert, White



**COMPONENTS: POWER SUPPLIES, CONTROLLERS AND MORE SEE PAGE 150.**



# PAPPARDELLE WITH PUMPKIN SAUCE

SERVES 4

- 4 tbsp butter
- 6 shallots, very finely chopped
- 1 lb 12 oz / 800 g pumpkin

Melt the butter in a large, heavy-bottom pan. Add the shallots, sprinkle with a little salt, cover, and cook over very low heat,





12VDC  
120V

# LINEAR



# FineLine 2.0

12VDC

4.4W/ft.  
(14.4W/m)

330 Lumens  
per ft.  
(1082 per meter)



Pencil thin but still packing a big punch, FineLine 2.0 is the unobtrusive way to provide stunning lighting to casework, displays, store fixtures and more. The low-profile design features a milk diffuser for even illumination, Luniform technology, and with optional manual or remote-control dimmers, creating the perfect atmosphere is effortless.

### Features:

Miniature Profile – 5/16" (8 mm)

120° beam angle

\*Luniform output – no "dots"

Available in (4) lengths – 8" (203 mm), 12" (305 mm), 22" (559 mm), or 34" (864 mm)

Linkable

79" (2 m) starter cord included

Surface mount

### Typical Applications:

Shelving

Displays or store fixtures

Interior and under cabinets

Food service equipment

Closets (UL listed for use within closet storage spaces)

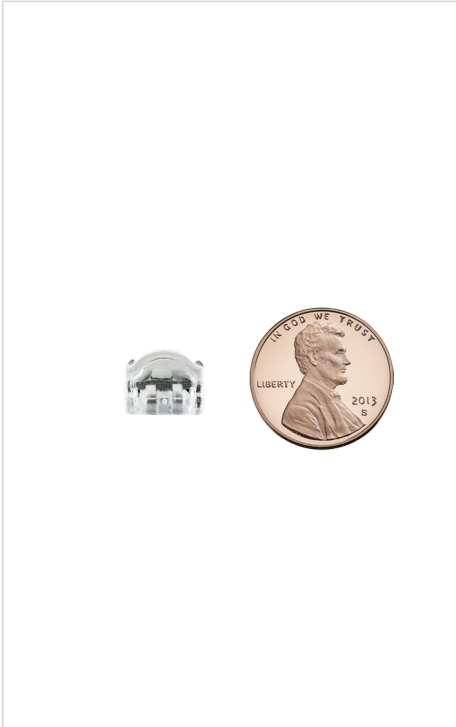

Extremely thin, 5/16" (8 mm) low-profile design

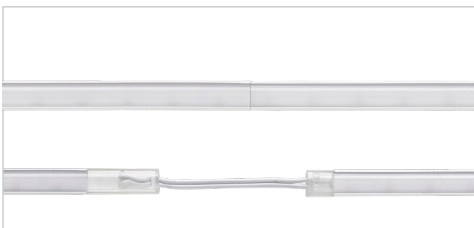

Linkable (seamless back-to-back or link cord) up to 12 ft. (3.66 m) continuous run

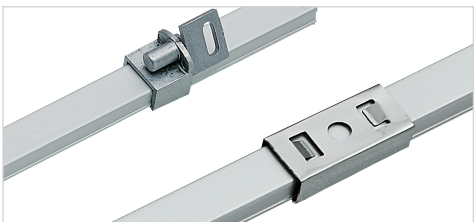

Straight and adjustable mounting U-clips included



### Available Finishes:



Aluminum (AL)

\*Fixture may require a slight angle using included swivel clips to eliminate diode reflection on some surfaces

### Dimensions:

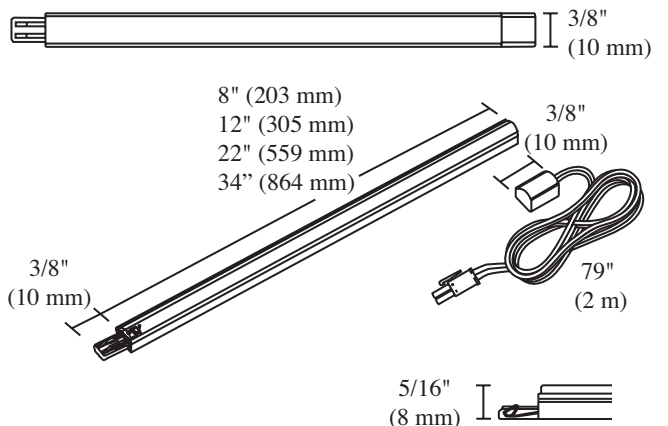

Typical Setup:

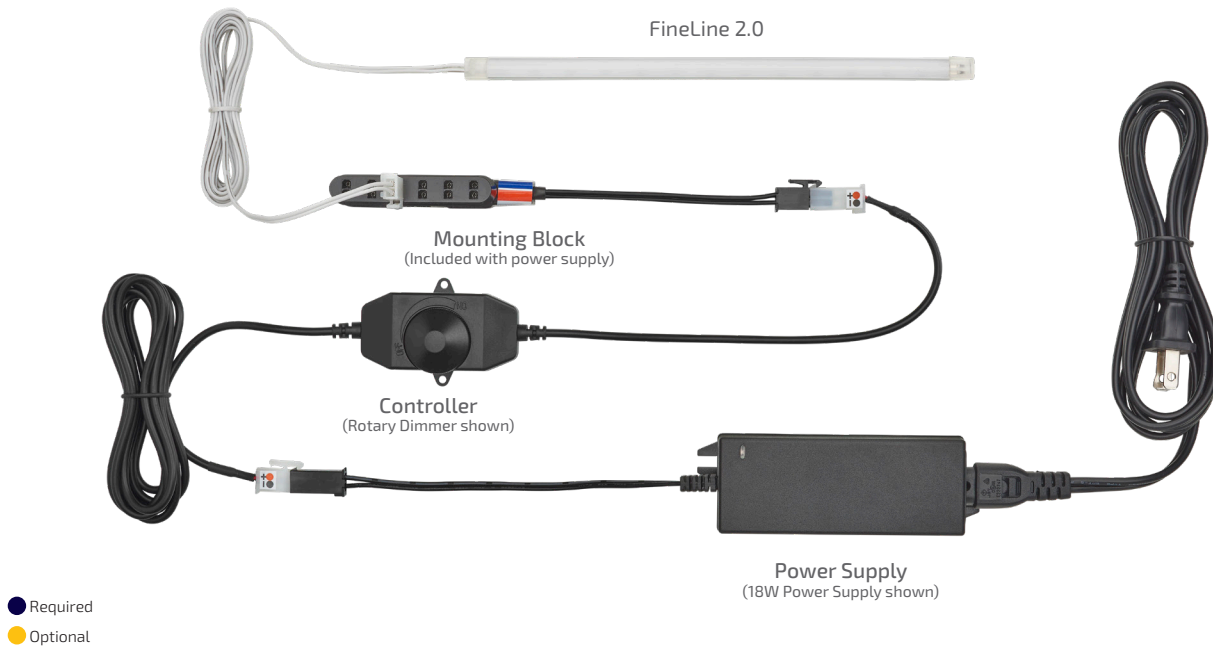

Accessories:

● Required



**Power Supplies**  
see power supply section

● Optional

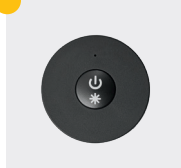

**Controllers**  
see controller section

● Optional



**FineLine Link Cord**  
L-LED-STKLNK-5-1  
L-LED-STKLNK-15-1  
L-LED-STKLNK-25-1  
L-LED-STKLNK-60-1  
L-LED-STKLNK-120-1  
L-LED-STKLNK-180-1

● Optional

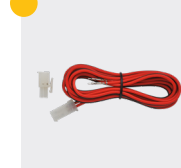

**Starter Cord Extensions**  
L-LED-LINKD-8-1  
L-LED-LINKD-15-1  
L-LED-LINKD-25-1  
L-LED-LINKD-60-1  
L-LED-LINKD-120-1  
L-LED-LINKD-180-1  
L-LED-LINKD-245-1

Specifications:

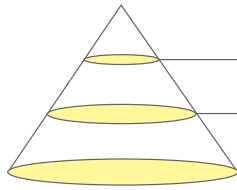
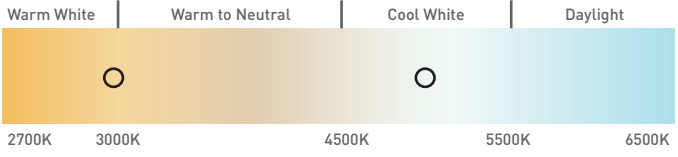
Wattage	Lumens	Efficacy (lm/W)	Input Voltage	Diode Life	Max Per 60W Power Supply	Max Continuous Run	Mounting	Warranty	Beam Angle												
4.4W/ft. (14.4W/m)	330 per ft. (1082 per m)	75	12VDC	50,000 Hours	13' (4 m)	12' (3.66 m)	Surface	5 Year													
Photometric Data					Color Temperature																
 <table border="1"> <thead> <tr> <th>Height</th> <th>Light Output</th> <th>Beam Area</th> </tr> </thead> <tbody> <tr> <td>1ft (.3 m)</td> <td>279Fc (3003.1lx)</td> <td>3.4ft L x 3.6ft W (1 m L x 1.1 m W)</td> </tr> <tr> <td>3ft (.9 m)</td> <td>31.0Fc (333.6lx)</td> <td>10.3ft L x 10.8ft W (3.1 m L x 3.3 m W)</td> </tr> <tr> <td>6ft (1.8 m)</td> <td>7.75Fc (83.4lx)</td> <td>20.5ft L x 21.6ft W (6.2 m L x 6.6 m W)</td> </tr> </tbody> </table> <p>L-STKH034-CNI-1 Tested</p>					Height	Light Output	Beam Area	1ft (.3 m)	279Fc (3003.1lx)	3.4ft L x 3.6ft W (1 m L x 1.1 m W)	3ft (.9 m)	31.0Fc (333.6lx)	10.3ft L x 10.8ft W (3.1 m L x 3.3 m W)	6ft (1.8 m)	7.75Fc (83.4lx)	20.5ft L x 21.6ft W (6.2 m L x 6.6 m W)	 <p>Warm White   Warm to Neutral   Cool White   Daylight</p> <p>2700K 3000K 4500K 5500K 6500K</p> <p>▲ Warm (3000K)      ▲ Cool (5000K)</p>				
Height	Light Output	Beam Area																			
1ft (.3 m)	279Fc (3003.1lx)	3.4ft L x 3.6ft W (1 m L x 1.1 m W)																			
3ft (.9 m)	31.0Fc (333.6lx)	10.3ft L x 10.8ft W (3.1 m L x 3.3 m W)																			
6ft (1.8 m)	7.75Fc (83.4lx)	20.5ft L x 21.6ft W (6.2 m L x 6.6 m W)																			

See page 60 for part numbers and descriptions



12VDC

# SimpLED 2.0

5W/ft.  
(16.4W/m)

470 Lumens  
per ft.  
(1541 per meter)



The SimpLED 2.0 sets the bar for light output and simplicity. With the patented push-in "H" connection system and inline control modules, you get the simplest and quickest installation possible. Use either straight or pivoting mounting clips, then snap the fixtures into place to let over 470 lumens per foot illuminate your project.

**US PATENT NO: 8,545,045**

### Features:

Clean, low-profile aluminum finish – 3/8" (10 mm)

Lunifrom output – no "dots"

Available in (3) lengths – 8" (203 mm), 12" (305 mm) or 22" (559 mm)

(3) diffuser options included

Linkable

Optional series of in-line controllers available

Integrated magnets for mounting to metal

Surface mount

### Typical Applications:

Showcases

Displays or store fixtures

Task lighting

Metal shelving

Office furniture

Under cabinet



Linkable (back-to-back or link cord) up to 10' (3 m) continuous run



Three diffuser options packaged with each light



Straight and adjustable mounting U-Clips and magnets included



### Available Finishes:



Aluminum (AL)

### Dimensions:

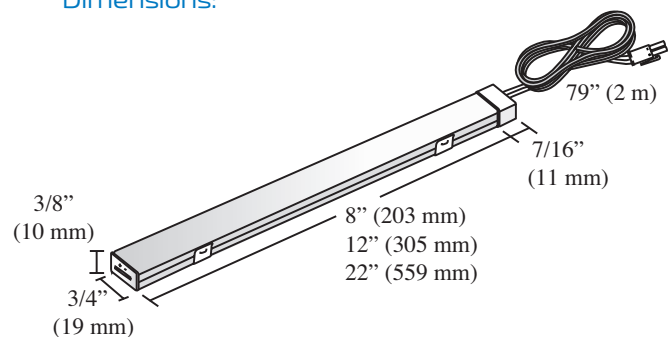

Typical Setup:

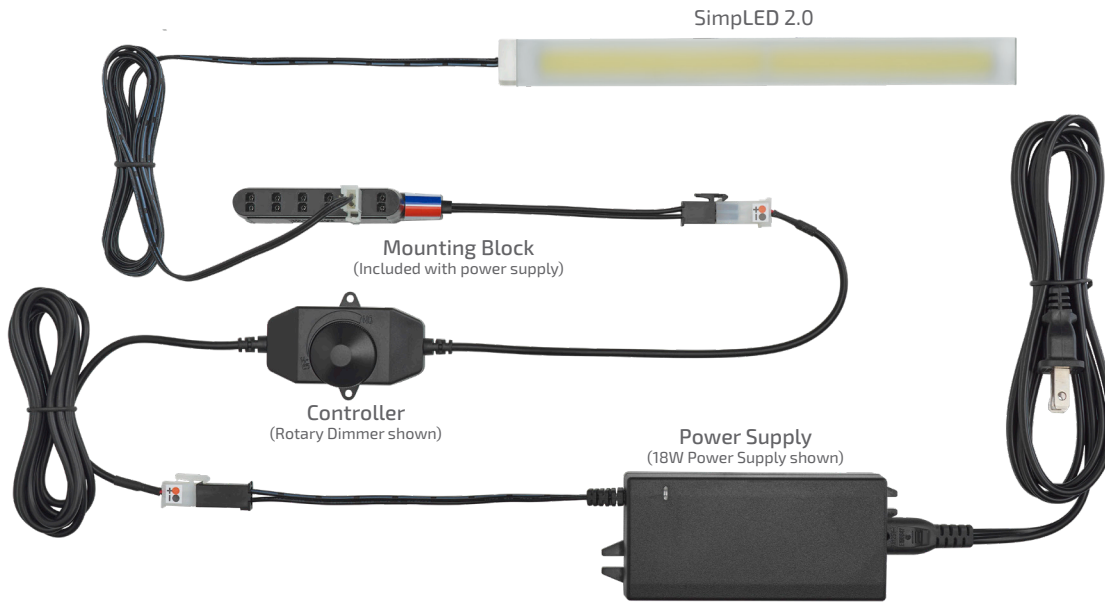

- Required
- Optional

Accessories:



**Power Supplies**  
see power supply section

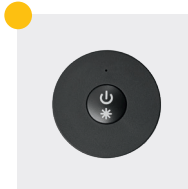

**Controllers**  
see controller section

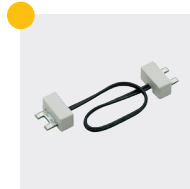

**SimpLED Link Cord**  
L-LED-SMPLNK-5-1  
L-LED-SMPLNK-15-1  
L-LED-SMPLNK-25-1  
L-LED-SMPLNK-60-1  
L-LED-SMPLNK-120-1  
L-LED-SMPLNK-180-1



**Rectangle Inline Touch Dimmer (27 Watt Max)**  
L-LED-SMPTD4-1



**Starter Cord Extensions**  
L-LED-LINKD-8-1  
L-LED-LINKD-15-1  
L-LED-LINKD-25-1  
L-LED-LINKD-60-1  
L-LED-LINKD-120-1  
L-LED-LINKD-180-1  
L-LED-LINKD-245-1

Specifications:

Wattage	Lumens	Efficacy (lm/W)	Input Voltage	Diode Life	Max Per 60W Power Supply	Max Continuous Run	Mounting	Warranty	Beam Angle								
5W/ft. (16.4W/m)	470 per ft. (1541 per m)	94	12VDC	50,000 Hours	12' (3.7 m)	10' (3 m)	Surface	5 Year									
Photometric Data					Color Temperature												
		<table border="1"> <thead> <tr> <th>Height</th> <th>Light Output</th> <th>Beam Area</th> </tr> </thead> <tbody> <tr> <td>1ft (.3 m)</td> <td>244.70Fc (2634lx)</td> <td>2.7ft L x 2.8ft W (.82 m L x .85 m W)</td> </tr> <tr> <td>3ft (.9 m)</td> <td>27.19Fc (292.7lx)</td> <td>8.2ft L x 8.3ft W (2.5 m L x 2.5 m W)</td> </tr> <tr> <td>6ft (1.8 m)</td> <td>6.80Fc (73.2lx)</td> <td>16.4ft L x 16.5ft W (5 m L x 5 m W)</td> </tr> </tbody> </table>	Height	Light Output	Beam Area	1ft (.3 m)	244.70Fc (2634lx)	2.7ft L x 2.8ft W (.82 m L x .85 m W)	3ft (.9 m)	27.19Fc (292.7lx)	8.2ft L x 8.3ft W (2.5 m L x 2.5 m W)	6ft (1.8 m)	6.80Fc (73.2lx)	16.4ft L x 16.5ft W (5 m L x 5 m W)			
Height	Light Output	Beam Area															
1ft (.3 m)	244.70Fc (2634lx)	2.7ft L x 2.8ft W (.82 m L x .85 m W)															
3ft (.9 m)	27.19Fc (292.7lx)	8.2ft L x 8.3ft W (2.5 m L x 2.5 m W)															
6ft (1.8 m)	6.80Fc (73.2lx)	16.4ft L x 16.5ft W (5 m L x 5 m W)															
L-SMPHO22-CNI-1 Tested																	

See page 61 for part numbers and descriptions

12VDC

# Eurolinx 2.0

**4W/ft.**  
(13.1W/m)

**216 Lumens per ft.**  
(708 per meter)



The Eurolinx 2.0 flat profile blends in with any application. Using a specialized diffuser and reflector technology to achieve uniform output, this European style light is a perfect choice for all contemporary and high-end commercial applications. Use the optional magnetic U-Clips for metal shelving or office furniture mounting. At 4W per foot and over 200 lumens, Eurolinx is a top pick for sleek high illumination.



Sleek, contemporary European design

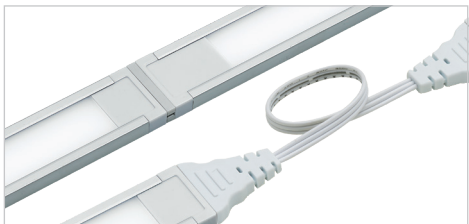

Linkable (back-to-back or link cord) up to 10' (3 m) continuous run



Mounting clips included. Mounting clips with magnets sold separately.

### Features:

Flat slim design – 5/16" (8 mm)

Two beam spreads based on orientation

Uniform output – no "dots"

Available in (5) lengths

Linkable

Surface mount

### Typical Applications:

Cabinets or shelving

Task lighting

Showcases



### Available Finishes:



Aluminum (AL)

### Dimensions:

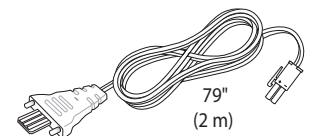
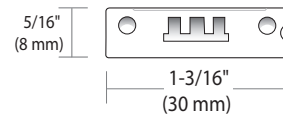
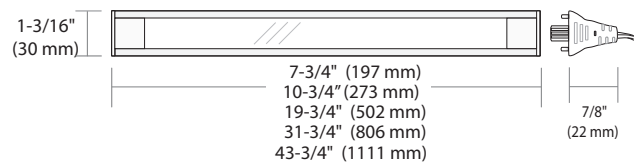



Typical Setup:

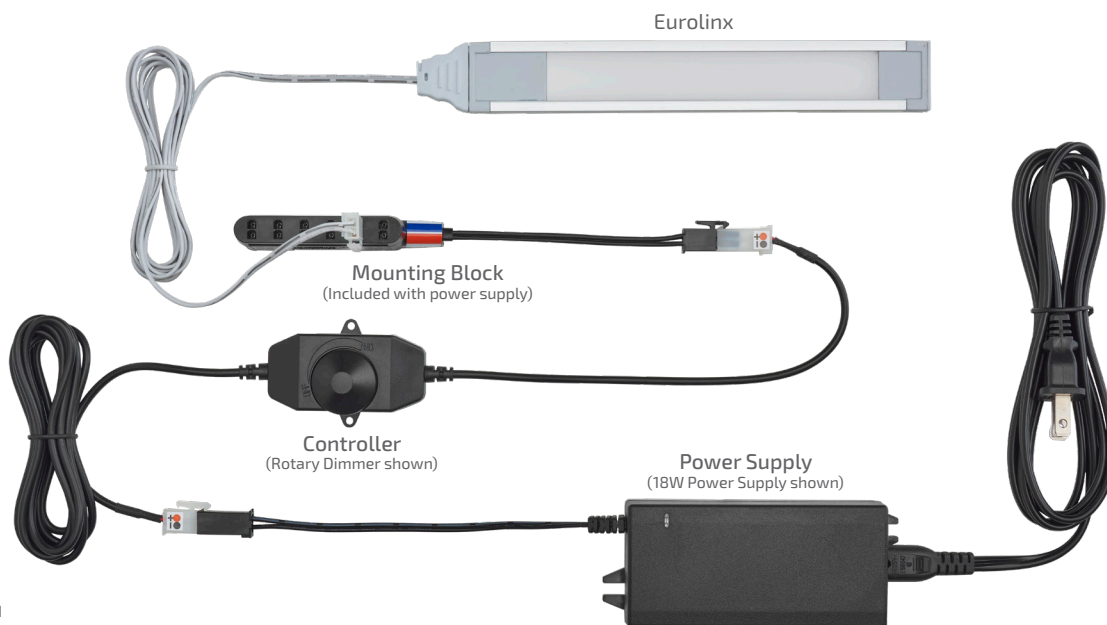

- Required
- Optional

Accessories:



**Power Supplies**  
see power supply section

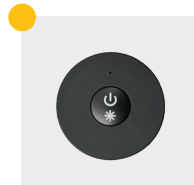

**Controllers**  
see controller section

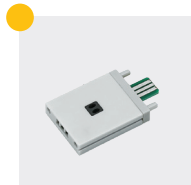

**Eurolinx Touch Dimmer (27 Watt Max)**  
L-EUL2-GTD2-1

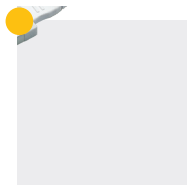

**Eurolinx Cords**  
L-EULNK2-15-WH-1  
L-EULNK2-25-WH-1  
L-EULNK2-60-WH-1  
L-EULNK2-120-WH-1  
L-EULNK2-180-WH-1

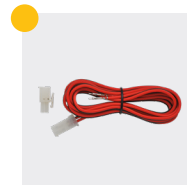

**Starter Cord Extensions**  
L-LED-LINKD-8-1  
L-LED-LINKD-15-1  
L-LED-LINKD-25-1  
L-LED-LINKD-60-1  
L-LED-LINKD-120-1  
L-LED-LINKD-180-1  
L-LED-LINKD-245-1

Specifications:

Wattage	Lumens	Efficacy (lm/W)	Input Voltage	Diode Life	Max Per 60W Power Supply	Max Continuous Run	Mounting	Warranty	Beam Angle												
4W/ft. (13.1W/m)	216 per ft. (708 per m)	54	12VDC	50,000 Hours	15' (4.6 m)	10' (3 m)	Surface	5 Year													
Photometric Data					Color Temperature																
		<table border="1"> <thead> <tr> <th>Height</th> <th>Light Output</th> <th>Beam Area</th> </tr> </thead> <tbody> <tr> <td>1ft (.3 m)</td> <td>266.60Fc (2870lx)</td> <td>2.9ft L x 3.3ft W (.88 m L x 1 m W)</td> </tr> <tr> <td>3ft (.9 m)</td> <td>29.62Fc (318.8lx)</td> <td>8.8ft L x 10ft W (2.7 m L x 3 m W)</td> </tr> <tr> <td>6ft (1.8 m)</td> <td>7.40Fc (79.6lx)</td> <td>17.6ft L x 20ft W (5.4 m L x 6 m W)</td> </tr> </tbody> </table>	Height	Light Output	Beam Area	1ft (.3 m)	266.60Fc (2870lx)	2.9ft L x 3.3ft W (.88 m L x 1 m W)	3ft (.9 m)	29.62Fc (318.8lx)	8.8ft L x 10ft W (2.7 m L x 3 m W)	6ft (1.8 m)	7.40Fc (79.6lx)	17.6ft L x 20ft W (5.4 m L x 6 m W)							
Height	Light Output	Beam Area																			
1ft (.3 m)	266.60Fc (2870lx)	2.9ft L x 3.3ft W (.88 m L x 1 m W)																			
3ft (.9 m)	29.62Fc (318.8lx)	8.8ft L x 10ft W (2.7 m L x 3 m W)																			
6ft (1.8 m)	7.40Fc (79.6lx)	17.6ft L x 20ft W (5.4 m L x 6 m W)																			
L-EUL15W-1111CAL-1 Tested																					

See page 62 for part numbers and descriptions

3.6W/ft.  
(11.8W/m)

200 Lumens  
per ft.  
(654 per meter)



12VDC

# Elli® Series

Limited quantities available

The patented Elli® Series is available in six lengths and features a square or an angled design that fits easily over glue or staples commonly found in cabinet and casework construction. High-output, wide-angle LEDs and fixture-to-fixture linking capability make for perfect, even illumination.

US PATENT NO: D577,857 and D574,107

### Features:

Wide 120° beam spread

(2) models: squared and angled

Available in (6) lengths

Instant on, instant brightness!

Linkable

Sleek and durable aluminum design

Surface mount

### Typical Applications:

Showcases

Jewelry cases

Task lighting

Store fixtures

Shelf lighting

Interior cabinet



Elli® V's patented angled design allows for tight corner mounting

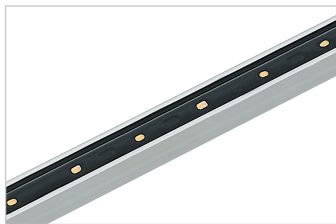

Elli® Z's square design is easy to install and conceal



Linkable up to 12' (3.6 m) continuous run

### Available Finishes:



Aluminum (AL)

### Dimensions:

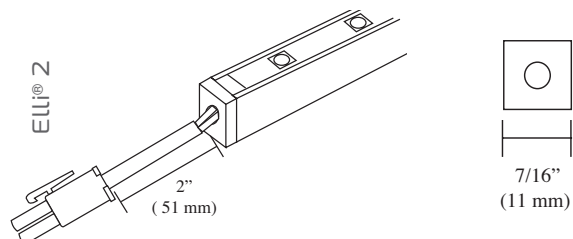
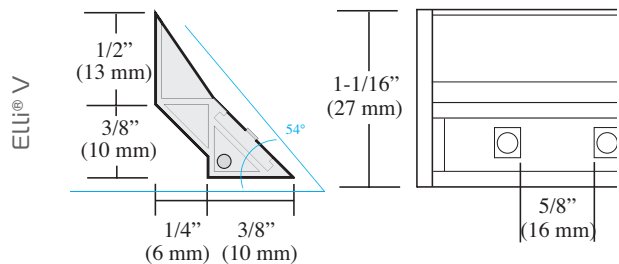

Typical Setup:

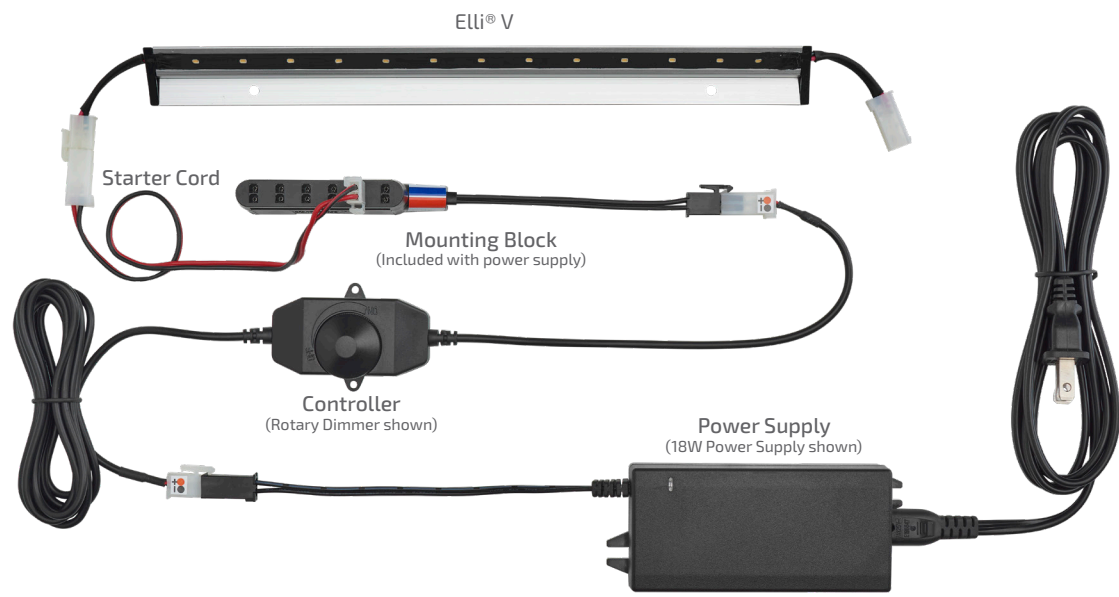

- Required
- Optional

Accessories:



**Power Supplies**  
see power supply section

**Starter Cord / Link Cord**  
L-LED-LINKD-8-1  
L-LED-LINKD-15-1  
L-LED-LINKD-25-1  
L-LED-LINKD-60-1  
L-LED-LINKD-120-1  
L-LED-LINKD-180-1  
L-LED-LINKD-245-1

**Controllers**  
see controller section

Specifications:

Wattage	Lumens	Efficacy (lm/W)	Input Voltage	Diode Life	Max Per 60W Power Supply	Max Continuous Run	Mounting	Warranty	Beam Angle										
3.6W/ft. (11.8W/m)	200 per ft. (654 per m)	55.4	12VDC	50,000 Hours	16' (4.88 m)	12' (3.66 m)	Surface	5 Year											
Photometric Data					Color Temperature														
		<table border="1"> <thead> <tr> <th>Height</th> <th>Light Output</th> <th>Beam Area</th> </tr> </thead> <tbody> <tr> <td>1ft (3 m)</td> <td>282.60Fc (3041.9lx)</td> <td>3ft L x 3ft W (.9 m L x .9 m W)</td> </tr> <tr> <td>3ft (.9 m)</td> <td>31.40Fc (338lx)</td> <td>9ft L x 9ft W (2.7 m L x 2.7 m W)</td> </tr> <tr> <td>6ft (1.8 m)</td> <td>7.85Fc (84.5lx)</td> <td>18ft L x 18.1ft W (5.5 m L x 5.5 m W)</td> </tr> </tbody> </table>	Height	Light Output	Beam Area	1ft (3 m)	282.60Fc (3041.9lx)	3ft L x 3ft W (.9 m L x .9 m W)	3ft (.9 m)	31.40Fc (338lx)	9ft L x 9ft W (2.7 m L x 2.7 m W)	6ft (1.8 m)	7.85Fc (84.5lx)	18ft L x 18.1ft W (5.5 m L x 5.5 m W)					
Height	Light Output	Beam Area																	
1ft (3 m)	282.60Fc (3041.9lx)	3ft L x 3ft W (.9 m L x .9 m W)																	
3ft (.9 m)	31.40Fc (338lx)	9ft L x 9ft W (2.7 m L x 2.7 m W)																	
6ft (1.8 m)	7.85Fc (84.5lx)	18ft L x 18.1ft W (5.5 m L x 5.5 m W)																	
L-LED-SQPR-1016CAL-1 Tested																			

See page 62 for part numbers and descriptions



Economy Series

12VDC

# EquiLine FineLine

2.4W/ft.  
(7.9W/m)

297 Lumens  
per ft.  
(971 per meter)



Long and narrow, FineLine is the unobtrusive way to provide smooth, linear lighting almost anywhere. The low profile design features a frosted diffuser for even illumination and with optional manual or remote control dimmers, creating the perfect atmosphere is effortless.

### Features:

Extremely thin, low-profile design – 5/16" (8 mm)

90° beam spread

Available in (3) lengths – 8" (203 mm), 12" (305 mm) or 22" (559 mm)

Linkable

Frosted diffuser

79" (2 m) starter cord included

Surface mount

### Typical Applications:

Shelving

Displays or store fixtures

Interior and under cabinets

Food service equipment



### Available Finishes:



Aluminum (AL)

### Dimensions:



8" (203 mm)

12" (305 mm)

22" (559 mm)

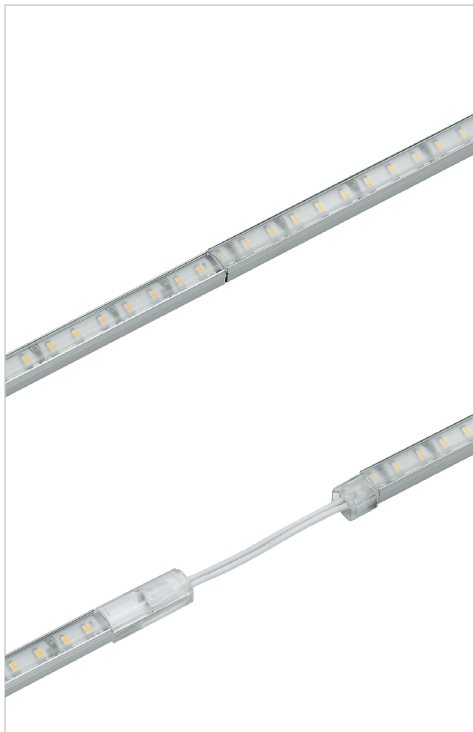
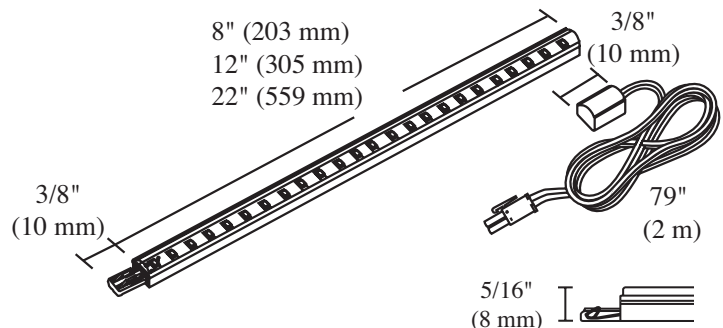

Linkable (back-to-back or link cord) up to 12' (3.66 m) continuous run

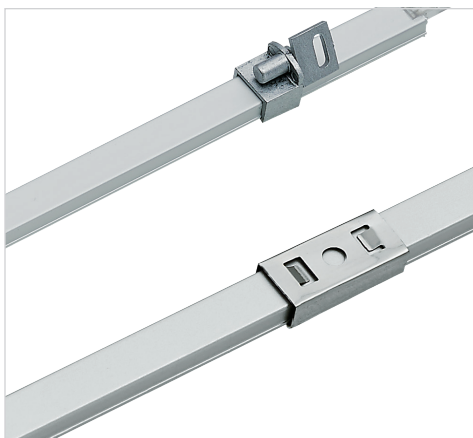

Straight and adjustable mounting U-Clips included

Typical Setup:

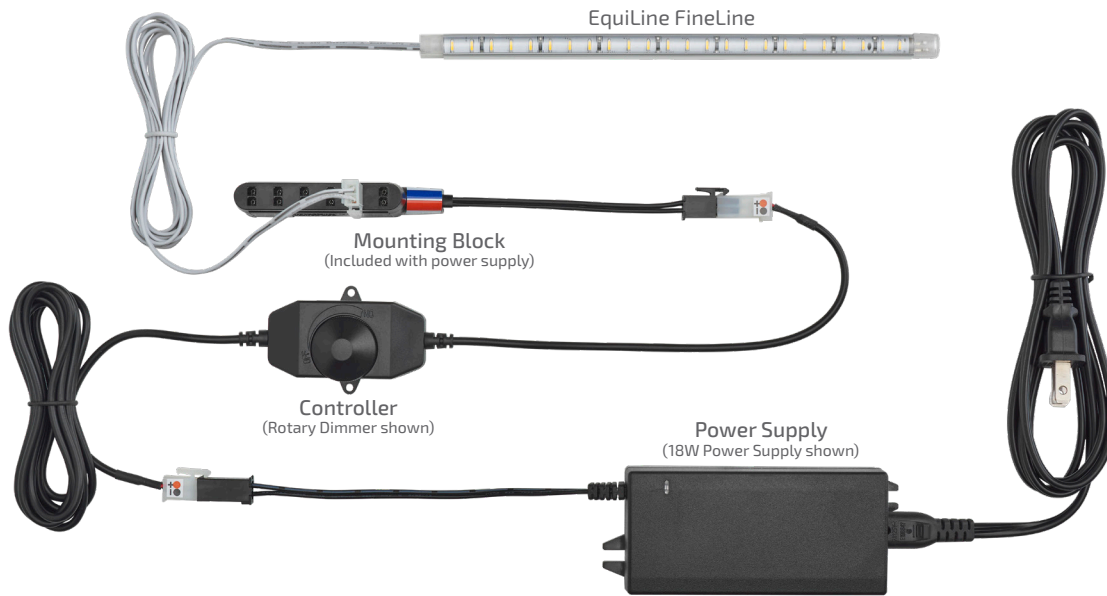

- Required
- Optional

Accessories:



**Power Supplies**  
see power supply section

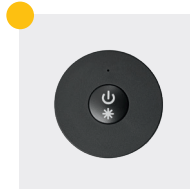

**Controllers**  
see controller section



**FineLine Link Cord**  
L-LED-STKLNK-5-1  
L-LED-STKLNK-15-1  
L-LED-STKLNK-25-1  
L-LED-STKLNK-60-1  
L-LED-STKLNK-120-1  
L-LED-STKLNK-180-1

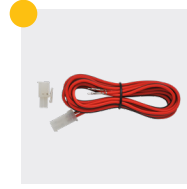

**Starter Cord Extensions**  
L-LED-LINKD-8-1  
L-LED-LINKD-15-1  
L-LED-LINKD-25-1  
L-LED-LINKD-60-1  
L-LED-LINKD-120-1  
L-LED-LINKD-180-1  
L-LED-LINKD-245-1

Specifications:

Wattage	Lumens	Efficacy (lm/W)	Input Voltage	Diode Life	Max Per 60W Power Supply	Max Continuous Run	Mounting	Warranty	Beam Angle								
2.4W/ft. (7.9W/m)	297 per ft. (971 per m)	124	12VDC	50,000 Hours	24' (7.32 m)	12' (3.66 m)	Surface	3 Year									
Photometric Data					Color Temperature												
		<table border="1"> <thead> <tr> <th>Height</th> <th>Light Output</th> <th>Beam Area</th> </tr> </thead> <tbody> <tr> <td>1ft (.3 m)</td> <td>284Fc (3056.9lx)</td> <td>3.2ft L x 1.7ft W (.97 m L x .52 m W)</td> </tr> <tr> <td>3ft (.9 m)</td> <td>31.5Fc (339.1lx)</td> <td>6.3ft L x 3.3ft W (1.9 m L x 1 m W)</td> </tr> <tr> <td>6ft (1.8 m)</td> <td>7.88Fc (84.8lx)</td> <td>19ft L x 9.9ft W (5.7 m L x 3 m W)</td> </tr> </tbody> </table>	Height	Light Output	Beam Area	1ft (.3 m)	284Fc (3056.9lx)	3.2ft L x 1.7ft W (.97 m L x .52 m W)	3ft (.9 m)	31.5Fc (339.1lx)	6.3ft L x 3.3ft W (1.9 m L x 1 m W)	6ft (1.8 m)	7.88Fc (84.8lx)	19ft L x 9.9ft W (5.7 m L x 3 m W)			
Height	Light Output	Beam Area															
1ft (.3 m)	284Fc (3056.9lx)	3.2ft L x 1.7ft W (.97 m L x .52 m W)															
3ft (.9 m)	31.5Fc (339.1lx)	6.3ft L x 3.3ft W (1.9 m L x 1 m W)															
6ft (1.8 m)	7.88Fc (84.8lx)	19ft L x 9.9ft W (5.7 m L x 3 m W)															
L-LED-STK22-CNI-1 Tested																	

See page 60 for part numbers and descriptions

# T5 Trescent® LED

120V

Limited quantities available



**4.3W/ft.**  
(14W/m)

**295 Lumens per ft.**  
(967 per meter)



Look again — that's not a fluorescent, that's a LED Linear Light. The T5 LED has the same low profile as fluorescent strip lights without the harmful material, costly energy consumption or bulb replacement and breakage. While fluorescent bulbs produce uneven light, the T5 LED Series produces even light throughout the length of the fixture, giving off 20 percent more light than other brands.

**Features:**

- Luniform output – no “dots”
- Available in (6) lengths
- Slim end cap design eliminates dark spots when linking
- Averages 30% less energy consumption than fluorescent equivalent
- No hum or flicker as found in similar fluorescent lights
- Instant on, instant brightness!
- Integrated on/off switch

**Typical Applications:**

- Displays
- Office furniture
- Cabinets or shelving
- Laboratory furniture
- Backlighting
- Soffit, perimeter lighting or cove lighting



Integrated on/off switch, proprietary diffuser to eliminate dotted appearance

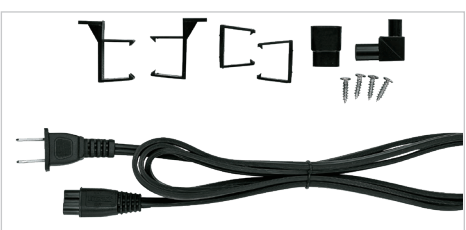

6' (1.8 m) starter cord, mounting clips, back-to-back connectors and 90° connectors included



Linkable up to 150W or 10 fixtures

**Available Finishes:**

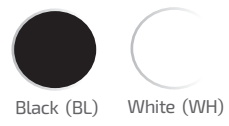

**Dimensions:**

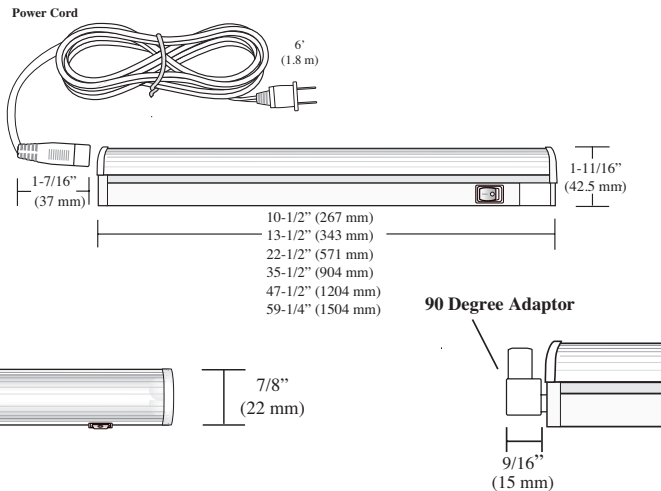







Typical Setup:



- Required
- Optional

Accessories:

 <p><b>Hardwire Boxes</b>                  L-HWB-WH-T5-1                  L-HWB-BL-T5-1                  L-HWB-WH-T5-S-1                  L-HWB-BL-T5-S-1</p>	 <p><b>Hardwire Box Adaptor</b>                  L-LTS-HWBADP-BL-1                  L-LTS-HWBADP-WH-1</p>	 <p><b>U Clips - Metal</b>                  L-TR55-UCLP-M-1</p>	 <p><b>Link Cord / Extension</b>                  L-LTS-LNK15-BL-1                  L-LTS-LNK15-WH-1                  L-LTS-LNK25-BL-1                  L-LTS-LNK25-WH-1                  L-LTS-LNK60-BL-1                  L-LTS-LNK60-WH-1                  L-LTS-LNK120-BL-1                  L-LTS-LNK120-WH-1                  L-LTS-LNK180-BL-1                  L-LTS-LNK180-WH-1</p>
---	---	---	---

Specifications:

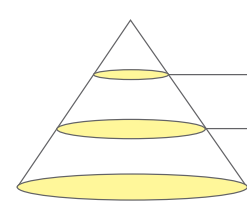
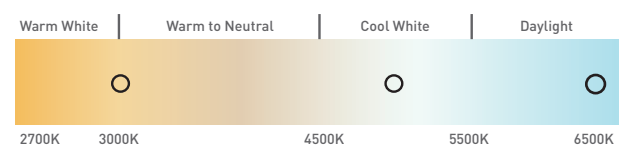
Wattage	Lumens	Efficacy (lm/W)	Input Voltage	Diode Life	Max Continuous Run	Mounting	Warranty	Beam Angle												
4.3W/ft. (14W/m)	295 per ft. (967 per m)	68.6	120V	30,000 Hours	10 Fixtures or up to 150W	Surface	3 Year													
Photometric Data					Color Temperature															
 <table border="1"> <thead> <tr> <th>Height</th> <th>Light Output</th> <th>Beam Area</th> </tr> </thead> <tbody> <tr> <td>1ft (.3 m)</td> <td>318.50Fc (3428.30lx)</td> <td>2.6ft L x 15.3ft W (.8 m L x 4.7 m W)</td> </tr> <tr> <td>3ft (.9 m)</td> <td>35.39Fc (380.93lx)</td> <td>7.9ft L x 45.8ft W (2.4 m L x 14 m W)</td> </tr> <tr> <td>6ft (1.8 m)</td> <td>8.85Fc (95.26lx)</td> <td>15.8ft L x 91.6ft W (4.8 m L x 27.9 m W)</td> </tr> </tbody> </table> <p>L-LTS18W-1204CWH-1 Tested</p>					Height	Light Output	Beam Area	1ft (.3 m)	318.50Fc (3428.30lx)	2.6ft L x 15.3ft W (.8 m L x 4.7 m W)	3ft (.9 m)	35.39Fc (380.93lx)	7.9ft L x 45.8ft W (2.4 m L x 14 m W)	6ft (1.8 m)	8.85Fc (95.26lx)	15.8ft L x 91.6ft W (4.8 m L x 27.9 m W)	 <p>Warm White   Warm to Neutral   Cool White   Daylight</p> <p>2700K 3000K 4500K 5500K 6500K</p> <p>▲ Warm (3000K)      ▲ Cool (5000K)      ▲ Daylight (6500K)</p>			
Height	Light Output	Beam Area																		
1ft (.3 m)	318.50Fc (3428.30lx)	2.6ft L x 15.3ft W (.8 m L x 4.7 m W)																		
3ft (.9 m)	35.39Fc (380.93lx)	7.9ft L x 45.8ft W (2.4 m L x 14 m W)																		
6ft (1.8 m)	8.85Fc (95.26lx)	15.8ft L x 91.6ft W (4.8 m L x 27.9 m W)																		

See page 64 for part numbers and descriptions

- Required
- Optional

● **12VDC FineLine 2.0 LED Series**

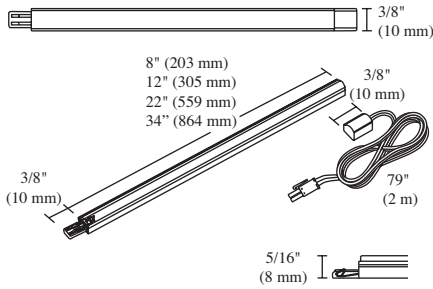

Part #	Description
L-STKH08-CNI-1	8" (203 mm) FineLine 2.0, 5000K, Nickel
L-STKH012-CNI-1	12" (305 mm) FineLine 2.0, 5000K, Nickel
L-STKH022-CNI-1	22" (559 mm) FineLine 2.0, 5000K, Nickel
L-STKH034-CNI-1	34" (864 mm) FineLine 2.0, 5000K, Nickel
L-STKH08-WNI-1	8" (203 mm) FineLine 2.0, 3000K, Nickel
L-STKH012-WNI-1	12" (305 mm) FineLine 2.0, 3000K, Nickel
L-STKH022-WNI-1	22" (559 mm) FineLine 2.0, 3000K, Nickel
L-STKH034-WNI-1	34" (864 mm) FineLine 2.0, 3000K, Nickel

Maximum continuous run of 12 ft. (3.7 m) to prevent voltage drop. Maximum 13 ft. (4 m) per 60W power supply. 79" (2 m) Starter Cord, AMP® Connector and mounting U-Clips are included with each light.

● **12VDC EquiLine FineLine LED Series**

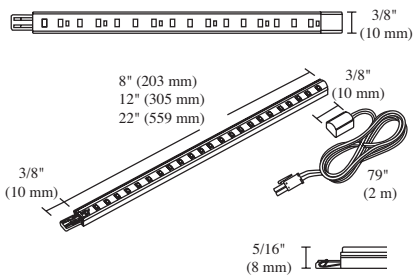

Part #	Description
L-LED-STK8-CNI-1	8" (203 mm) EquiLine FineLine, 5000K, Nickel
L-LED-STK12-CNI-1	12" (305 mm) EquiLine FineLine, 5000K, Nickel
L-LED-STK22-CNI-1	22" (559 mm) EquiLine FineLine, 5000K, Nickel
L-LED-STK8-WNI-1	8" (203 mm) EquiLine FineLine, 3000K, Nickel
L-LED-STK12-WNI-1	12" (305 mm) EquiLine FineLine, 3000K, Nickel
L-LED-STK22-WNI-1	22" (559 mm) EquiLine FineLine, 3000K, Nickel

Maximum continuous run of 12 ft. (3.7 m) to prevent voltage drop. Maximum 24 ft. (7.3 m) per 60W power supply. 79" (2 m) Starter Cord, AMP® Connector and mounting U-Clips are included with each light.

● **12VDC FineLine Link Cord**

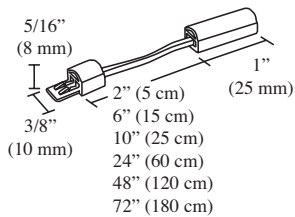

Part #	Description
L-LED-STKLNK-5-1	5 cm (2") 12VDC Stick Linking Cord
L-LED-STKLNK-15-1	15 cm (6") 12VDC Stick Linking Cord
L-LED-STKLNK-25-1	25 cm (10") 12VDC Stick Linking Cord
L-LED-STKLNK-60-1	60 cm (24") 12VDC Stick Linking Cord
L-LED-STKLNK-120-1	120 cm (48") 12VDC Stick Linking Cord
L-LED-STKLNK-180-1	180 cm (72") 12VDC Stick Linking Cord



**COMPONENTS: POWER SUPPLIES, CONTROLLERS AND MORE SEE PAGE 150.**

● 12VDC SimplLED 2.0 Series

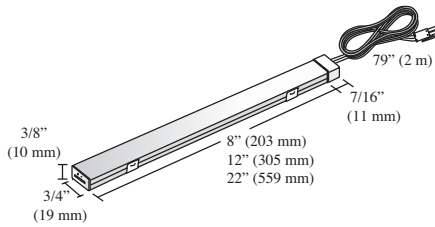

Part #	Description
L-SMPHO8-CNI-1	8" (203 mm) 12VDC SimplLED 2.0, 5000K, Nickel
L-SMPHO12-CNI-1	12" (305 mm) 12VDC SimplLED 2.0, 5000K, Nickel
L-SMPHO22-CNI-1	22" (559 mm) 12VDC SimplLED 2.0, 5000K, Nickel
L-SMPHO8-WNI-1	8" (203 mm) 12VDC SimplLED 2.0, 3000K, Nickel
L-SMPHO12-WNI-1	12" (305 mm) 12VDC SimplLED 2.0, 3000K, Nickel
L-SMPHO22-WNI-1	22" (559 mm) 12VDC SimplLED 2.0, 3000K, Nickel

Maximum continuous run 10 ft. (3 m) to prevent voltage drop. Maximum 12 ft. (3.6 m) per power supply.  
79" (2 m) Starter Cord, AMP® Connector, H-Shaped Connector, and Mounting U-Clips are included with each light.  
3 diffusers (Clear, Frosted and Milk/Opal) are included with each light.

● 12VDC SimplLED Link Cord

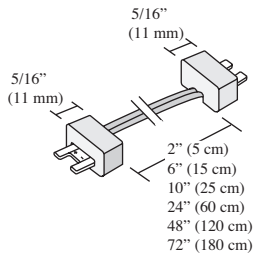

Part #	Description
L-LED-SMPLNK-5-1	5 cm (2") 12VDC SimplLED Linking Cord
L-LED-SMPLNK-15-1	15 cm (6") 12VDC SimplLED Linking Cord
L-LED-SMPLNK-25-1	25 cm (10") 12VDC SimplLED Linking Cord
L-LED-SMPLNK-60-1	60 cm (24") 12VDC SimplLED Linking Cord
L-LED-SMPLNK-120-1	120 cm (48") 12VDC SimplLED Linking Cord
L-LED-SMPLNK-180-1	180 cm (72") 12VDC SimplLED Linking Cord

● 12VDC SimplLED Control Module

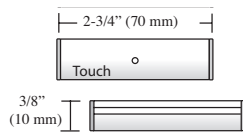

Part #	Description
L-LED-SMPTD4-1	27W Rectangle Inline Touch Dimmer

Controls up to 5.4 ft. (1.6 m) of SimplLED 2.0 lights.  
Max load 27W.



COMPONENTS: POWER SUPPLIES, CONTROLLERS AND MORE SEE PAGE 150.



● 12VDC Eurolinx Series

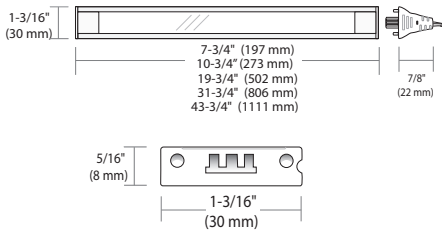

Part #	Description
L-EUL3W2-197CAL-1	197 mm (7-3/4") 12VDC 3W Eurolinx 2.0, 5000K
L-EUL4W2-273CAL-1	273 mm (10-3/4") 12VDC 4W Eurolinx 2.0, 5000K
L-EUL7W2-502CAL-1	502 mm (19-3/4") 12VDC 7W Eurolinx 2.0, 5000K
L-EUL11W2-806CAL-1	806 mm (31-3/4") 12VDC 11W Eurolinx 2.0, 5000K
L-EUL15W2-1111CAL-1	1111 mm (43-3/4") 12VDC 15W Eurolinx 2.0, 5000K
L-EUL3W2-197WAL-1	197 mm (7-3/4") 12VDC 3W Eurolinx 2.0, 3000K
L-EUL4W2-273WAL-1	273 mm (10-3/4") 12VDC 4W Eurolinx 2.0, 3000K
L-EUL7W2-502WAL-1	502 mm (19-3/4") 12VDC 7W Eurolinx 2.0, 3000K
L-EUL11W2-806WAL-1	806 mm (31-3/4") 12VDC 11W Eurolinx 2.0, 3000K
L-EUL15W2-1111WAL-1	1111 mm (43-3/4") 12VDC 15W Eurolinx 2.0, 3000K

Maximum continuous run 10 ft. (3 m) to prevent voltage drop. Maximum 15 ft. (4.6 m) per 60W power supply. Each light includes 79" (2 m) cord, U-Clips, and back-to-back connector.

● 12VDC Eurolinx Link Cords

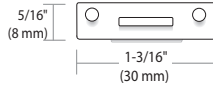
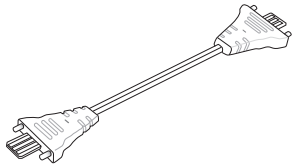
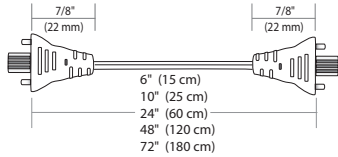

Part #	Description
L-EULNK2-15-WH-1	15 cm (6") Eurolinx 2.0, Linking Cord, White
L-EULNK2-25-WH-1	25 cm (10") Eurolinx 2.0, Linking Cord, White
L-EULNK2-60-WH-1	60 cm (24") Eurolinx 2.0, Linking Cord, White
L-EULNK2-120-WH-1	120 cm (48") Eurolinx 2.0, Linking Cord, White
L-EULNK2-180-WH-1	180 cm (72") Eurolinx 2.0, Linking Cord, White

● 12VDC Eurolinx Touch Dimmer

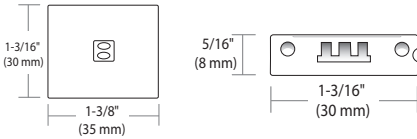

Part #	Description
L-EUL2-GTD2-1	27W Eurolinx 2.0, Gradual Inline Touch Dimmer

Controls up to 6.75 ft. (2 m) of Eurolinx Lights. Max load 27W.

● 12VDC Elli® V Series

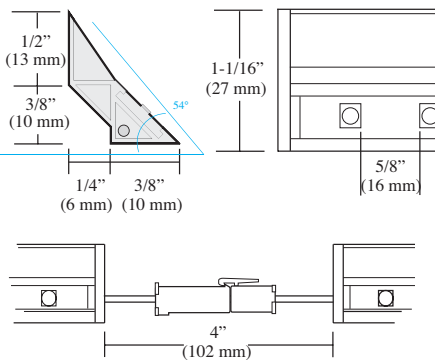

Part #	Description
L-LED-AGLPR-250CAL-1	279 mm (11") Elli® V LED, 4800K, Aluminum
L-LED-AGLPR-406CAL-1	432 mm (17") Elli® V LED, 4800K, Aluminum
L-LED-AGLPR-711CAL-1	737 mm (29") Elli® V LED, 4800K, Aluminum
L-LED-AGLPR-1016CAL-1	1041 mm (41") Elli® V LED, 4800K, Aluminum
L-LED-AGLPR-250WAL-1	279 mm (11") Elli® V LED, 3500K, Aluminum
L-LED-AGLPR-406WAL-1	432 mm (17") Elli® V LED, 3500K, Aluminum
L-LED-AGLPR-559WAL-1	584 mm (23") Elli® V LED, 3500K, Aluminum
L-LED-AGLPR-711WAL-1	737 mm (29") Elli® V LED, 3500K, Aluminum
L-LED-AGLPR-864WAL-1	889 mm (35") Elli® V LED, 3500K, Aluminum
L-LED-AGLPR-1016WAL-1	1041 mm (41") Elli® V LED, 3500K, Aluminum

Maximum continuous run 12 ft. (3.65 m) to prevent voltage drop. 16 ft. (4.88 m) maximum per power supply.



COMPONENTS: POWER SUPPLIES, CONTROLLERS AND MORE SEE PAGE 150.

● 12VDC Elli® 2 Series

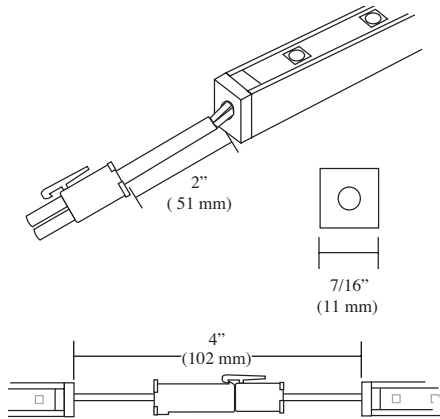

Part #	Description
L-LED-SQPR-559CAL-1	584 mm (23") Elli® 2 LED, 4800K, Aluminum
L-LED-SQPR-864CAL-1	889 mm (35") Elli® 2 LED, 4800K, Aluminum
L-LED-SQPR-1016CAL-1	1041 mm (41") Elli® 2 LED, 4800K, Aluminum
L-LED-SQPR-250WAL-1	279 mm (11") Elli® 2 LED, 3500K, Aluminum
L-LED-SQPR-406WAL-1	432 mm (17") Elli® 2 LED, 3500K, Aluminum
L-LED-SQPR-559WAL-1	584 mm (23") Elli® 2 LED, 3500K, Aluminum
L-LED-SQPR-864WAL-1	889 mm (35") Elli® 2 LED, 3500K, Aluminum

Maximum continuous run 12 ft. (3.65 m) to prevent voltage drop. 16 ft. (4.88 m) maximum per power supply.

● 12VDC Starter Cord Extensions

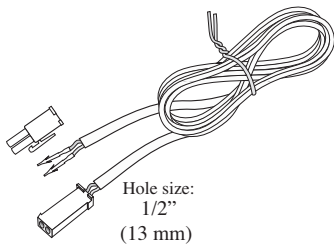

Part #	Description
L-LED-LINKD-8-1	8 cm (3") 12VDC Starter/Link/Extension Cord
L-LED-LINKD-15-1	15 cm (6") 12VDC Starter/Link/Extension Cord
L-LED-LINKD-25-1	25 cm (10") 12VDC Starter/Link/Extension Cord
L-LED-LINKD-60-1	60 cm (24") 12VDC Starter/Link/Extension Cord
L-LED-LINKD-120-1	120 cm (48") 12VDC Starter/Link/Extension Cord
L-LED-LINKD-180-1	180 cm (72") 12VDC Starter/Link/Extension Cord
L-LED-LINKD-245-1	245 cm (96") 12VDC Starter/Link/Extension Cord

● 12VDC Power Supplies



Part #	Description
L-DC-SLELT30-1	30W 12VDC Power Supply w/6 Snap Mounting Block*
L-DC-SLELT60-1	60W 12VDC Power Supply w/6 Snap Mounting Block*
L-DC-ELT6WP-CON-1	6W 12VDC Wall Mount Power Supply w/3 Snap Block*
L-DC-ELT15WP-CON-1	15W 12VDC Wall Mount Power Supply w/6 Snap Block*
L-DC-EQ30-1	30W 12VDC Equiline Power Supply w/6 Snap Block*
L-DC-EQ60-1	60W 12VDC Equiline Power Supply w/6 Snap Block*
L-DCE30D-CON-1	30W 12VDC Hardwire Dimmable LED Power Supply†
L-DCE60D-CON-1	60W 12VDC Hardwire Dimmable LED Power Supply†
L-12DCH60X1-1	60W 12VDC Commercial/Industrial Metal Hardwire Dimmable Power Supply‡
L-12DCH60X3-1	180W 12VDC Commercial/Industrial Metal Hardwire Dimmable Power Supply‡
L-12DCH60X5-120-277V-1	300W 12VDC Commercial Hardwire 0-10V Dimmable Power Supply

\* Dimmable on trailing edge (12VDC side). Mounting block and power cord are included.

† Dimmable by LED line voltage (120V) wall dimmers. Mounting block included.

‡ Dimmable by LED line voltage (120V) wall dimmers. Mounting block not included

All hardwire power supplies require an electrician for install.



COMPONENTS: POWER SUPPLIES, CONTROLLERS AND MORE SEE PAGE 150.

- Required
- Optional

● 120V T5 Trescent® LED Series

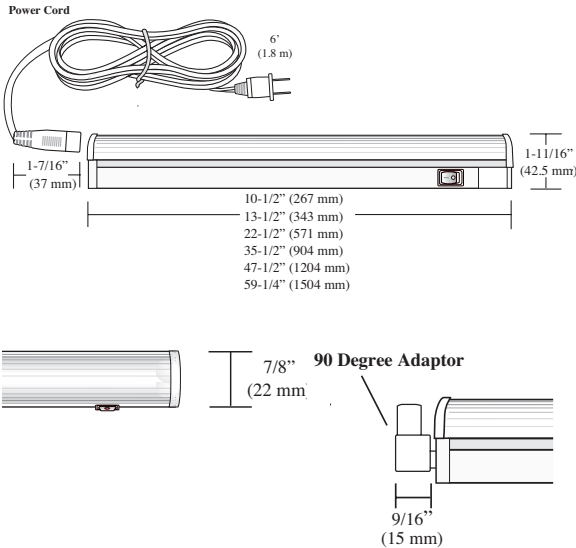

Part #	Description
L-LT53W-267D*-1	T5 LED 3W 6500K 10.5" (267 mm)
L-LT53W-267C*-1	T5 LED 3W 5000K 10.5" (267 mm)
L-LT53W-267W*-1	T5 LED 3W 3000K 10.5" (267 mm)
L-LT54W-343D*-1	T5 LED 4W 6500K 13.5" (343 mm)
L-LT54W-343C*-1	T5 LED 4W 5000K 13.5" (343 mm)
L-LT54W-343W*-1	T5 LED 4W 3000K 13.5" (343 mm)
L-LT57W-571D*-1	T5 LED 7W 6500K 22.5" (571 mm)
L-LT57W-571W*-1	T5 LED 7W 3000K 22.5" (571 mm)
L-LT514W-904C*-1	T5 LED 14W 5000K 35.5" (904 mm)
L-LT514W-904W*-1	T5 LED 14W 3000K 35.5" (904 mm)
L-LT518W-1204D*-1	T5 LED 18W 6500K 47.5" (1204 mm)
L-LT518W-1204C*-1	T5 LED 18W 5000K 47.5" (1204 mm)
L-LT518W-1204W*-1	T5 LED 18W 3000K 47.5" (1204 mm)
L-LT525W-1504D*-1	T5 LED 25W 6500K 59.25" (1504 mm)
L-LT525W-1504C*-1	T5 LED 25W 5000K 59.25" (1504 mm)
L-LT525W-1504W*-1	T5 LED 25W 3000K 59.25" (1504 mm)

\*For white fixture use (WH), for black use (BL).  
6 ft. (1.8 m) starter cord, straight and 90° U-Clips, back-to-back connector and 90° Adaptor included.

● 120V Hardwire Boxes

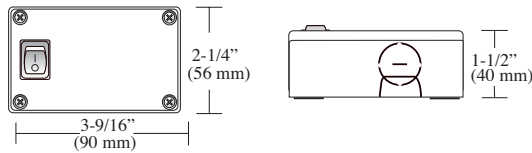

Part #	Description
L-HWB-BL-T5-1	T5 Black Hardwire Box, without Switch
L-HWB-WH-T5-S-1	T5 White Hardwire Box, with Switch
L-HWB-BL-T5-S-1	T5 Black Hardwire Box, with Switch

\*Adaptor cord is required for proper connection.

● 120V Hardwire Box Adaptor



Part #	Description
L-LT5-HWBADP-BL-1	T5 LED Hardwire Box Adaptor, Black
L-LT5-HWBADP-WH-1	T5 LED Hardwire Box Adaptor, White

● U Clips - Metal

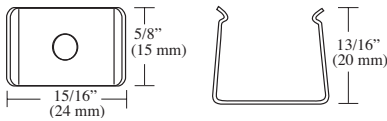

Part #	Description
L-TR55-UCLP-M-1	Metal T5 Replacement U-clips, Set of 2

● 120V Link Cord / Extension

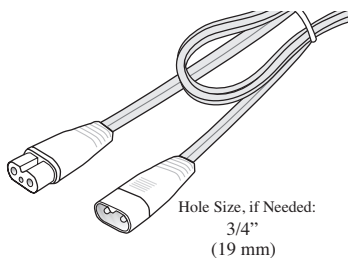

Part #	Description
L-LT5-LNK15-BL-1	6" (15 cm) Black T5 Trescent® LED Linking Cord
L-LT5-LNK15-WH-1	6" (15 cm) White T5 Trescent® LED Linking Cord
L-LT5-LNK25-BL-1	10" (25 cm) Black T5 Trescent® LED Linking Cord
L-LT5-LNK60-BL-1	24" (60 cm) Black T5 Trescent® LED Linking Cord
L-LT5-LNK60-WH-1	24" (60 cm) White T5 Trescent® LED Linking Cord
L-LT5-LNK120-BL-1	48" (120 cm) Black T5 Trescent® LED Linking Cord
L-LT5-LNK120-WH-1	48" (120 cm) White T5 Trescent® LED Linking Cord
L-LT5-LNK180-BL-1	72" (180 cm) Black T5 Trescent® LED Linking Cord
L-LT5-LNK180-WH-1	72" (180 cm) White T5 Trescent® LED Linking Cord







Photo by Ronnie Wood

tresco  
lighting

12VDC

24VDC



















# TAPE



# TAPE

## Single Color FlexTape® At a Glance

All tape measured at 1' lengths.

	1.5W FlexTape®	3W FlexTape®	4.4W FlexTape®	5.5W FlexTape®	COB FlexTape® 12VDC/ 24VDC	Edge Emitting FlexTape®	1.5W EquiLine Tape	3W EquiLine Tape	4.4W EquiLine Tape
Tape Width	10 mm	10 mm	10 mm	10 mm	10 mm	10 mm	10 mm	10 mm	10 mm
Roll Length	20'	16.4'	13'	10'	13'/16.4'	16.4'	20'	16.4'	13'
Wattage	1.5W/ft.	3W/ft.	4.4W/ft.	5.5W/ft.	4.4W/ft. 5.5W/ft.	2.5W/ft.	1.5W/ft.	3W/ft.	4.4W/ft.
Lumens/ft.	150	365	420	615	245/420	195	135	255	395
Input Voltage	12VDC	12VDC	12VDC	12VDC	12VDC/24VDC	12VDC	12VDC	12VDC	12VDC
Beam Angle									
Max Continuous Run	20'	16.4'	13'	10'	13'/16.4'	16.4'	20'	16.4'	13'
Diode Life	50,000	50,000	50,000	50,000	50,000	50,000	25,000	25,000	25,000
CRI	>90	>90	>90	>90	>90	>83	>83	>83	>83
Warranty	5 years	5 years	5 years	5 years	5 years	5 years	2 years	2 years	2 years
Safety Certifications									
Color Temperatures	2700, 3000, 3500, 4800, 6500, Red, Blue	2700, 3000, 3500, 4800, 6500, Red, Blue	2700, 3000, 3500, 4800, 6500	2700, 3000, 3500, 4800, 6500	2700, 3000, 3500, 4800, 6500	2700, 3500, 4800, 6500	2700, 3000, 3500, 4800, 6500	2700, 3000, 3500, 4800, 6500	2700, 3000, 3500, 4800, 6500
Dimmable	Yes	Yes	Yes	Yes	Yes	Yes	Yes	Yes	Yes

Note: Above chart represents averages per foot. Many factors can affect actual output.



12VDC

24VDC

# Tape

## Tape System Overview

A unique design makes our Tape Lighting the most versatile LED light on earth. Curve them under frosted glass to create a stunning display or run them under shelving for continuous illumination. The tape features an adhesive backing for easy peel-and-stick installation.

### Features:

No soldering required - simple FlexConnect connectors

White color printed board maximizes light output

Lower heat, longer life than competing brands

Available in multiple color temperatures and colors

Cutttable and linkable

Can be used with Infinex Series

### Typical Applications:

Store fixtures

Edge lighting

Backlighting

Accent lighting

Cove lighting

Toe kick

Soffit



Easy to use FlexConnect system with reliable connections



Strong adhesive backing



Sold by the roll



Typical Setup:

12VDC

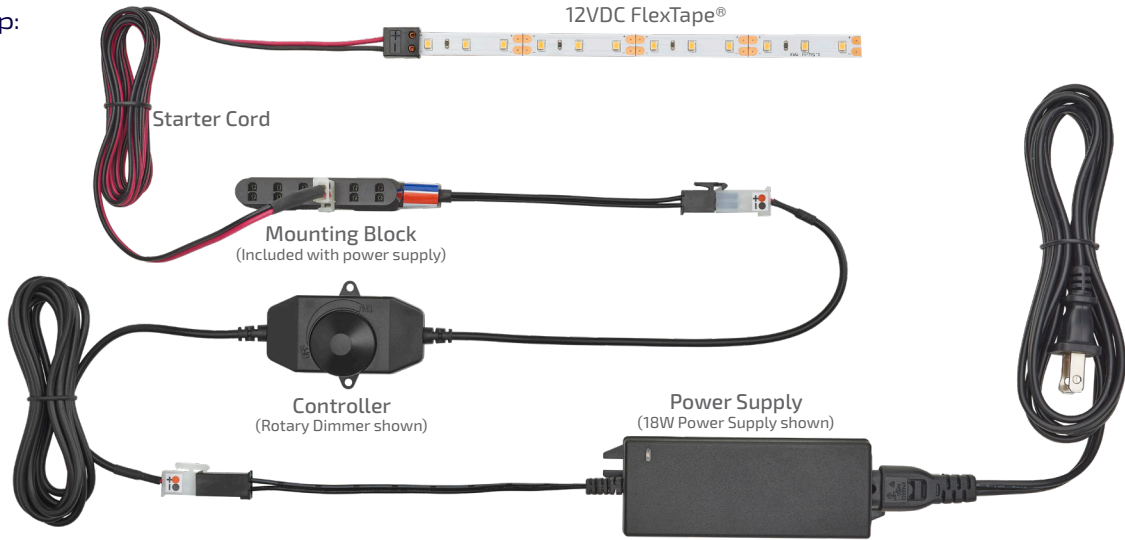



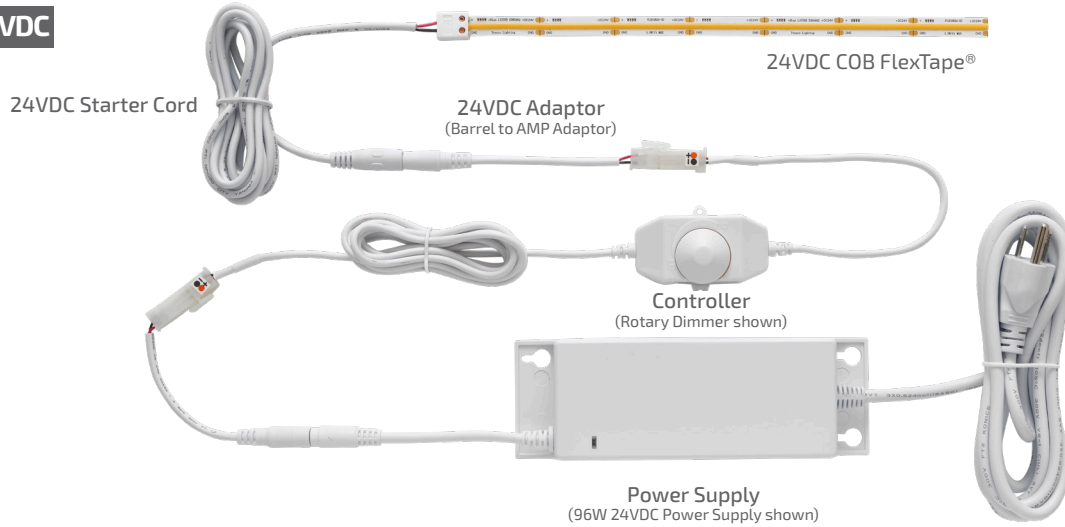



24VDC

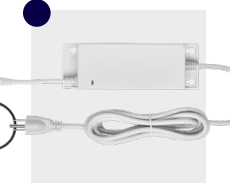
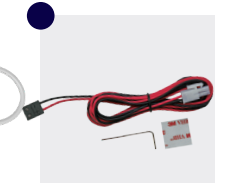

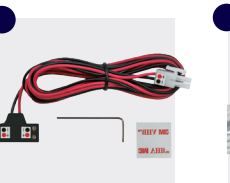
● Required  
● Optional

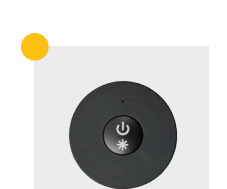
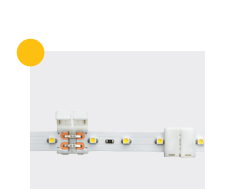
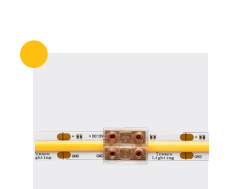
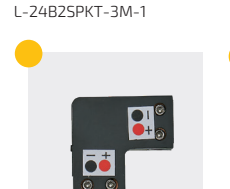
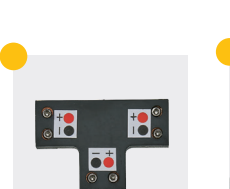
Accessories:

 <p>12VDC Power Supplies see power supply section</p>	 <p>24VDC Power Supplies see power supply section</p>	 <p>12VDC Starter Cord L-LED-TPEPKT-2M-1 L-TPEPKT-2IN-1</p>	 <p>24VDC Starter Cord L-24B2SPKT-305MM-1 L-24B2SPKT-2M-1 L-24B2SPKT-3M-1</p>	 <p>12VDC Tee Starter Cord L-LED-TPEPKT-2M-TEE-1</p>	 <p>24VDC Tee Starter Cord L-24B2SPKT-2M-TEE-1</p>
 <p>Controllers see controller section</p>	 <p>Standard FlexTape® Back-to-Back Connector L-TPELNK-BTB-1</p>	 <p>COB Back-to-Back Connector L-XSBTB-1</p>	 <p>Right Angle Connector L-LED-TPELNK-CON90-1</p>	 <p>Tee Connector L-LED-TPELNK-TEE-1</p>	 <p>Link Cord L-LED-TPELNK-5-1 L-LED-TPELNK-15-1 L-LED-TPELNK-25-1 L-LED-TPELNK-60-1 L-LED-TPELNK-120-1 L-LED-TPELNK-180-1</p>

12VDC

# FlexTape® 1.5W

<b>1.5W/ft.</b> (4.9W/m)	<b>150 Lumens</b> per ft. (492 per meter)	 <b>115°</b>
-----------------------------	---	--

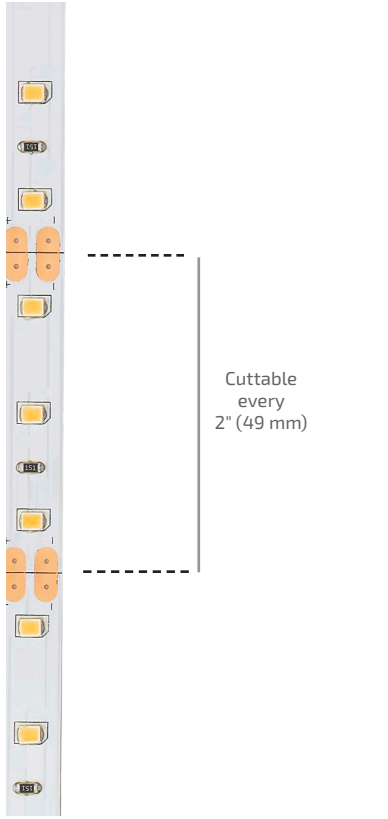



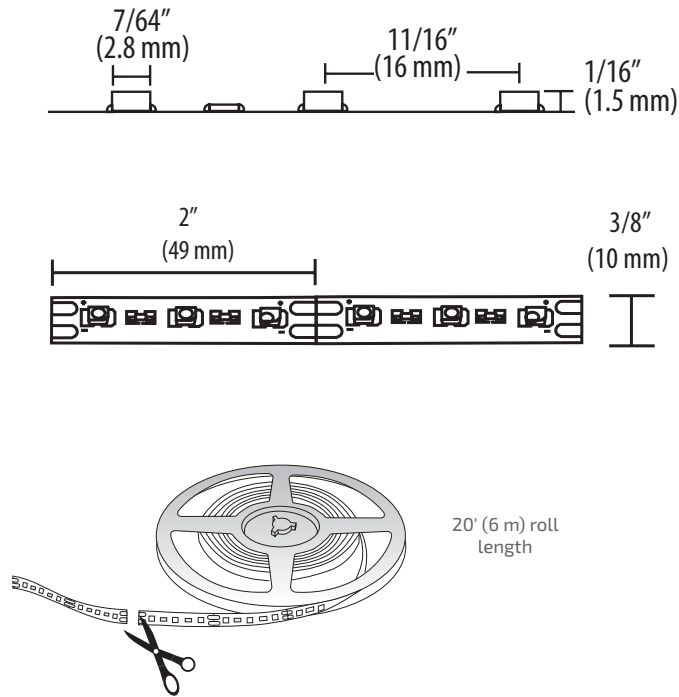



Dimensions:

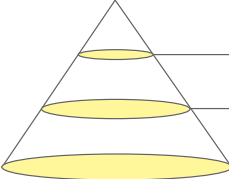

Specifications:



Wattage	Lumens	Efficacy (lm/W)	Input Voltage	Diode Life	Max Per 60W Power Supply	Max Continuous Run	Mounting	Warranty	Beam Angle
1.5W/ft. (4.9W/m)	150 per ft. (492 per m)	100	12VDC	50,000 Hours	40' (12 m)	20' (6 m)	Surface	5 Year	

Photometric Data				Color Temperature				
	Height	Light Output	Beam Area	Warm White	Warm to Neutral	Cool White	Daylight	
	1ft (3m)	49.2Fc (529.6lx)	3.3ft L x 3.3ft W (1 m L x 1 m W)					
	3ft (.9m)	5.47Fc (58.9lx)	9.8ft L x 10ft W (3 m L x 3 m W)	2700K ▲ Warm (2700K)	3000K ▲ Warm (3000K)	4500K ▲ Neutral (3500K)	5500K ▲ Cool (4800K)	6500K ▲ Daylight (6500K)
6ft (1.8m)	1.37Fc (14.7lx)	19.5ft L x 20ft W (5.9 m L x 6.1 m W)					● Red Available    ● Blue Available	

L-LED-FLXTPE-CROLL-1 Tested

See page 82 for part numbers and descriptions

12VDC

# FlexTape® 3W

<b>3W/ft.</b> (9.8W/m)	<b>365 Lumens</b> per ft. (1197 per meter)	<b>115°</b>
---------------------------	--	-------------



Cuttable every 1" (25 mm)

Dimensions:

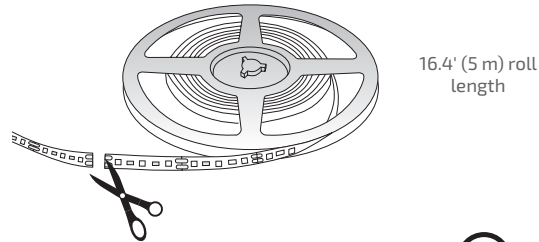
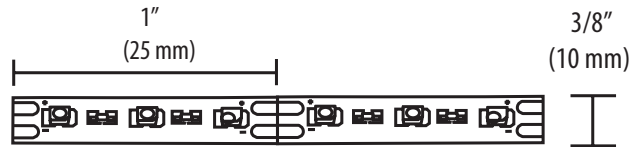
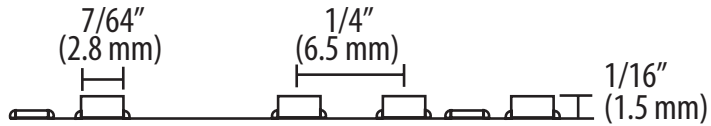

16.4' (5 m) roll length

Specifications:



Wattage	Lumens	Efficacy (lm/W)	Input Voltage	Diode Life	Max Per 60W Power Supply	Max Continuous Run	Mounting	Warranty	Beam Angle
3W/ft. (9.8W/m)	365 per ft. (1197 per m)	120	12VDC	50,000 Hours	20' (6 m)	16.4' (5 m)	Surface	5 Year	

Photometric Data				Color Temperature				
	Height	Light Output	Beam Area	Warm White	Warm to Neutral	Cool White	Daylight	
	1ft (3 m)	120Fc (1219.7lx)	3.4ft L x 3.3ft W (1.1 m L x 1 m W)	2700K	3000K	4500K	6500K	
	3ft (.9 m)	13.3Fc (143.2lx)	10.1ft L x 9.8ft W (3.1 m L x 3 m W)	Warm (2700K)	Warm (3000K)	Neutral (3500K)	Cool (4800K)	Daylight (6500K)
	6ft (1.8 m)	3.33Fc (35.8lx)	20.2ft L x 19.6ft W (6.2 m L x 6 m W)	● Red Available	● Blue Available			

L-LED-FLXTPE-CRHO-1 Tested

See page 82 for part numbers and descriptions



# FlexTape® 4.4W

12VDC

<b>4.4W/ft.</b> (14.4W/m)	<b>420 Lumens</b> per ft. (1378 per meter)	 <b>115°</b>
------------------------------	--	--



Cuttable every 2" (49 mm)

Dimensions:

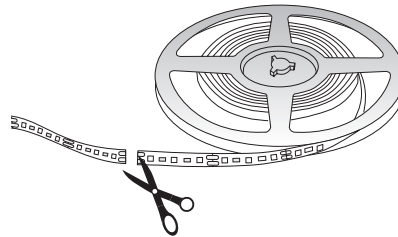
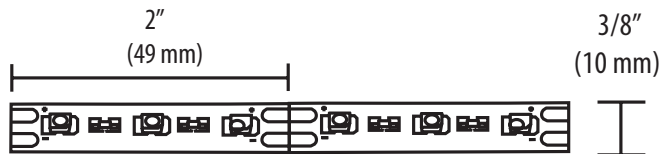
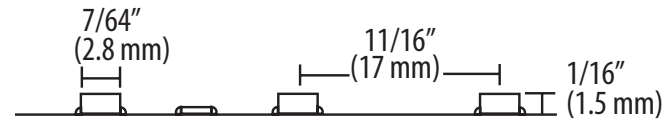



13' (3.96 m) roll length

Specifications:

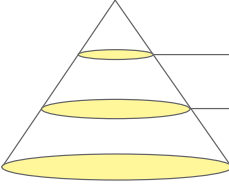

Wattage	Lumens	Efficacy (lm/W)	Input Voltage	Diode Life	Max Per 60W Power Supply	Max Continuous Run	Mounting	Warranty	Beam Angle
4.4W/ft. (14.4W/m)	420 per ft. (1378 per m)	95	12VDC	50,000 Hours	13' (3.96 m)	13' (3.96 m)	Surface	5 Year	

Photometric Data				Color Temperature					
	Height	Light Output	Beam Area						
	1ft (.3 m)	140Fc (1507lx)	3.2ft L x 3.3ft W (.98 m L x .91 m W)	2700K	3000K	3500K	4500K	5500K	6500K
	3ft (.9 m)	15.5Fc (166.8lx)	9.7ft L x 9.8ft W (3 m L x 3 m W)	Warm (2700K)	Warm (3000K)	Neutral (3500K)	Cool (4800K)		Daylight (6500K)
	6ft (1.8 m)	3.88Fc (41.8lx)	19.4ft L x 19.7ft W (5.9 m L x 6 m W)						

L-FLXTPE-CRV-1 Tested

See page 82 for part numbers and descriptions

12VDC

# FlexTape® 5.5W

**5.5W/ft.**  
(18W/m)

**615 Lumens**  
per ft.  
(2017 per meter)



Only to be used with Infinex



Cuttable every 1-1/2" (38 mm)

Dimensions:

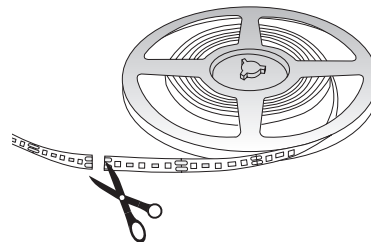
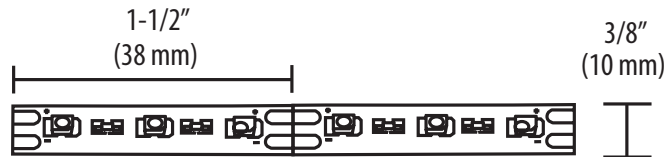
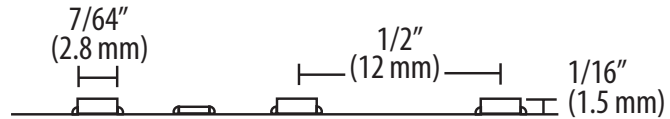

10' (3 m) roll length

Specifications:



Wattage	Lumens	Efficacy (lm/W)	Input Voltage	Diode Life	Max Per 60W Power Supply	Max Continuous Run	Mounting	Warranty	Beam Angle
5.5W/ft. (18W/m)	615 per ft. (2017 per m)	112	12VDC	50,000 Hours	10' (3 m)	10' (3 m)	Surface	5 Year*	115°

Photometric Data

Color Temperature

Height	Light Output	Beam Area
1ft (.3m)	205Fc (2207lx)	3.3ft L x 3.1ft W (1 m L x .94 m W)
3ft (.9m)	22.8Fc (245lx)	10ft L x 9.3ft W (3 m L x 2.8 m W)
6ft (1.8 m)	5.69Fc (61.3lx)	19.9ft L x 18.6ft W (6 m L x 5.6 m W)

L-FLXTPE-48RU-1 Tested

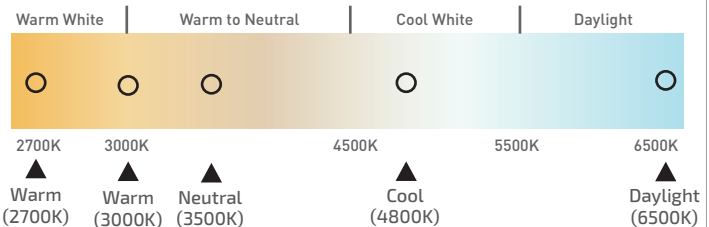

\*MUST USE PROPER HEAT SINK (i.e. Infinex Aluminum Extrusions)

See page 82 for part numbers and descriptions

# Edge Emitting FlexTape®

12VDC

<b>2.5W/ft.</b> (8.2W/m)	<b>194 Lumens</b> per ft. (636 per meter)	 <b>110°</b>
-----------------------------	---	---

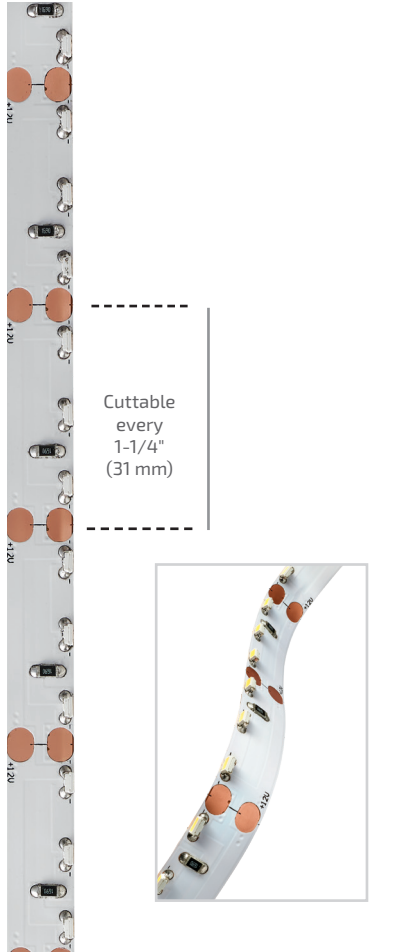

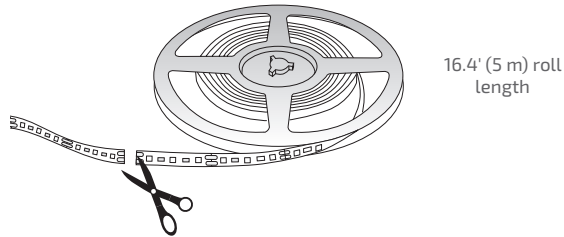
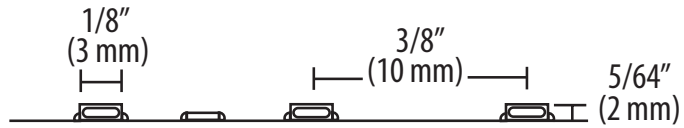

Dimensions:

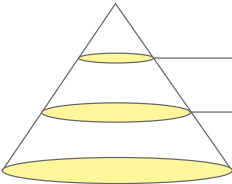

Specifications:

Wattage	Lumens	Efficacy (lm/W)	Input Voltage	Diode Life	Max Per 60W Power Supply	Max Continuous Run	Mounting	Warranty	Beam Angle
2.5W/ft. (8.2W/m)	194 per ft. (636 per m)	78	12VDC	50,000 Hours	24' (7.3 m)	16.4' (5 m)	Surface	5 Year	

Photometric Data				Color Temperature				
	Height	Light Output	Beam Area					
	1ft (.3 m)	80Fc (861.1lx)	3.1ft L x 2.8ft W (.94 m L x .85 m W)	2700K	3000K	4500K	5500K	6500K
	3ft (.9 m)	8.90Fc (9.7lx)	9.4ft L x 8.3ft W (2.9 m L x 2.5 m W)	Warm (2700K)	Neutral (3500K)	Cool (4800K)	Daylight (6500K)	
6ft (1.8 m)	2.22Fc (23.7lx)	18.9ft L x 16.7ft W (5.8 m L x 5.1 m W)						

L-FLXTPE-65EER-1 Tested

See page 83 for part numbers and descriptions



Economy Series

12VDC

# EquiLine Tape LED 1.5W

**1.5W/ft.**  
(4.9W/m)

**135 Lumens per ft.**  
(443 per meter)



Cuttable every 2" (49 mm)

Dimensions:

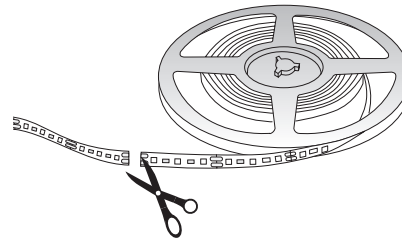
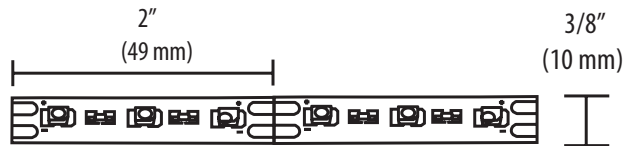
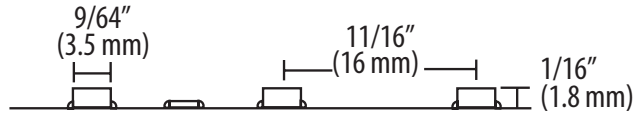

20' (6 m) roll length



Specifications:

Wattage	Lumens	Efficacy (lm/W)	Input Voltage	Diode Life	Max Per 60W Power Supply	Max Continuous Run	Mounting	Warranty	Beam Angle
1.5W/ft. (4.9W/m)	135 per ft. (443 per m)	90	12VDC	25,000 Hours	40' (12 m)	20' (6 m)	Surface	2 Year	115°

Photometric Data

Height	Light Output	Beam Area
1ft (.3m)	44.1Fc (474.6lx)	3.1ft L x 3.3ft W (.9 m L x 1 m W)
3ft (.9m)	4.9Fc (52.7lx)	9.4ft L x 9.8ft W (2.9 m L x 3 m W)
6ft (1.8 m)	1.23Fc (13.3lx)	18.8ft L x 19.6ft W (5.7 m L x 6 m W)

L-TPELED-48SER-1 Tested

Color Temperature

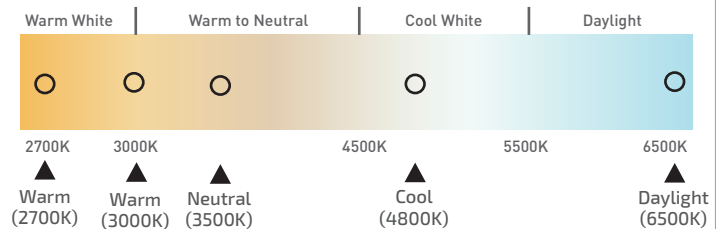

See page 83 for part numbers and descriptions

# EquiLine Tape LED

Economy Series

## EquiLine Tape LED 3W

12VDC

3W/ft.  
(9.8W/m)

255 Lumens  
per ft.  
(836 per meter)



### Dimensions:

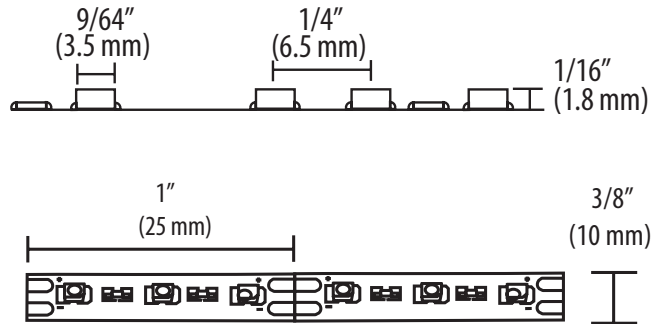

Cuttable every 1" (25 mm)

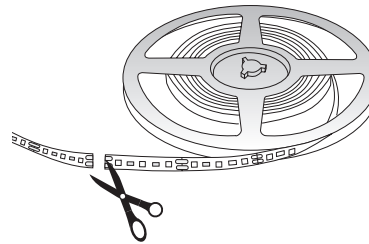

16.4' (5 m) roll length



### Specifications:

Wattage	Lumens	Efficacy (lm/W)	Input Voltage	Diode Life	Max Per 60W Power Supply	Max Continuous Run	Mounting	Warranty	Beam Angle
3W/ft. (9.8W/m)	255 per ft. (836 per m)	85	12VDC	25,000 Hours	20' (6 m)	16.4' (5 m)	Surface	2 Year	

### Photometric Data

Height	Light Output	Beam Area
1ft (.3 m)	83.9Fc (903.1lx)	3.2ft L x 3.3ft W (1 m L x 1 m W)
3ft (.9 m)	9.32Fc (100.3lx)	9.5ft L x 9.9ft W (2.9 m L x 3 m W)
6ft (1.8 m)	2.33Fc (25.1lx)	19.1ft L x 19.9ft W (5.8 m L x 6.1 m W)

L-TPELED-48HER-1 Tested

### Color Temperature

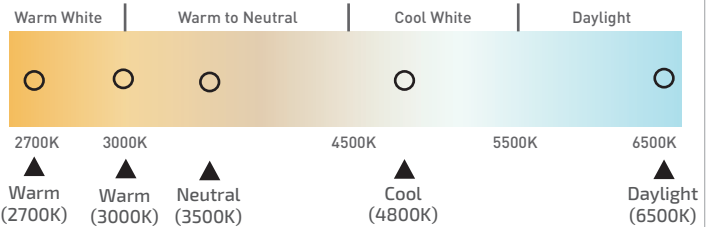

See page 83 for part numbers and descriptions

**Economy Series**  
**EquiLine Tape LED 4.4W**

12VDC

<b>4.4W/ft.</b> (14.4W/m)	<b>395 Lumens per ft.</b> (1296 per meter)	<b>115°</b>
------------------------------	---	-------------



Cuttable every 1" (25 mm)

Dimensions:

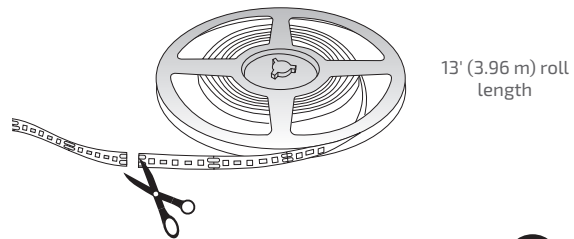
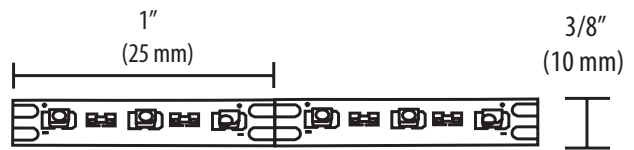
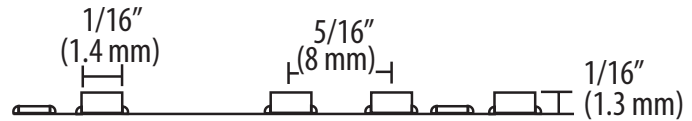

13' (3.96 m) roll length



Specifications:

Wattage	Lumens	Efficacy (lm/W)	Input Voltage	Diode Life	Max Per 60W Power Supply	Max Continuous Run	Mounting	Warranty	Beam Angle
4.4W/ft. (14.4W/m)	395 per ft. (1296 per m)	89	12VDC	25,000 Hours	13' (3.96 m)	13' (3.96 m)	Surface	2 Year	<b>115°</b>

Photometric Data				Color Temperature				
	Height	Light Output	Beam Area					
	1ft (0.3m)	135Fc (1453lx)	3.4ft L x 3.3ft W (1 m L x 1 m W)	2700K	3000K	4500K	5500K	6500K
	3ft (0.9m)	14.9Fc (160.4lx)	10.1ft L x 10ft W (3.1 m L x 3 m W)	Warm (2700K)	Warm (3000K)	Neutral (3500K)	Cool (4800K)	Daylight (6500K)
6ft (1.8m)	3.74Fc (40.3lx)	20.2ft L x 20.0ft W (6.2 m L x 6.1 m W)						

L-TPELED-48VER-1 Tested

See page 83 for part numbers and descriptions

# COB FlexTape®

12VDC

4.4W/ft.  
(14.5W/m)

245 Lumens  
per ft.  
(809 per meter)



Chip on Board or "COB" FlexTape® is the latest advancement in tape lighting. With diodes directly mounted on a printed circuit board and a continuous fortified coating, this flexible, high density LED lighting strip creates our Luniform look without dark spots – no covers or filters needed!

## Features:

New generation of tape lighting

115° beam angle

Available in 2700K, 3000K, 3500K, 4800K or 6500K

Wattage: 4.4W/ft. – 13' (4 m) roll

Cuttable every 11/16" (18 mm)

High-density lighting

Can be used with Inflex extrusions (sold separately)

Indoor use only

## Typical Applications:

Store fixtures

Edge lighting

Backlighting

Accent lighting

Cove lighting

Toe kick

Soffit



## Dimensions:

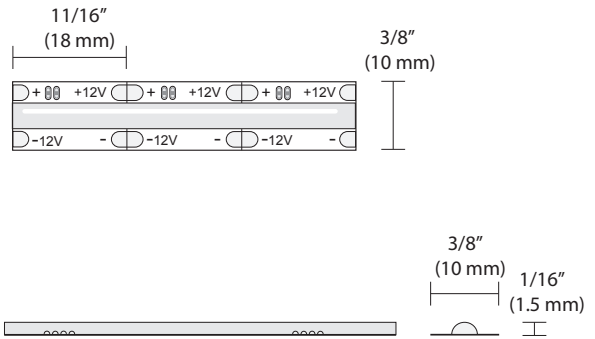

Cuttable every  
11/16"  
(18 mm)

Encapsulated diodes are protected from splashes, dust and moisture.



Luniform look without dark spots



Strong 300 LSE 3M™ adhesive backing



Typical Setup:

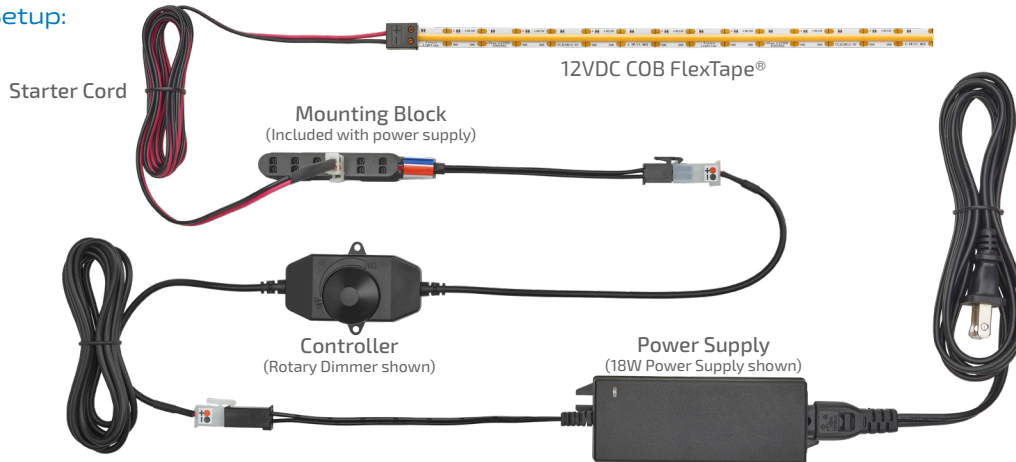

- Required
- Optional

Accessories:

**Power Supplies**  
see power supply section

**Starter Cord**  
L-LED-TPEPKT-2M-1  
L-TPEPKT-2IN-1

**Tee Starter Cord**  
L-LED-TPEPKT-2M-TEE-1

**Controllers**  
see controller section

**Back-to-Back Connector**  
L-XSBTB-1

**Tee Connector**  
L-LED-TPELNK-TEE-1

**Right Angle Connector**  
L-LED-TPELNK-CON90-1

**Link Cord**  
L-LED-TPELNK-5-1  
L-LED-TPELNK-15-1  
L-LED-TPELNK-25-1  
L-LED-TPELNK-60-1  
L-LED-TPELNK-120-1  
L-LED-TPELNK-180-1

Specifications:

Wattage	Lumens	Efficacy (lm/W)	Input Voltage	Diode Life	Max Per Power Supply 60W (12VDC)	Max Continuous Run	Mounting	Warranty	Beam Angle
4.4W/ft. (14.5W/m)	245 per ft. (809 per m)	55.7	12VDC	50,000 Hours	13' (4 m)	13' (4 m)	Surface	5 year	
Photometric Data					Color Temperature				
	Height	Light Output	Beam Area		<div style="display: flex; justify-content: space-between;"> <span>Warm White</span> <span>Warm to Neutral</span> <span>Cool White</span> <span>Daylight</span> </div>				
	1ft (.3 m)	74.7Fc (804lx)	3.1ft L x 10.9ft W (94 m L x 3.3 m W)		2700K	3000K	4500K	5500K	6500K
	3ft (.9 m)	8.3Fc (89.3lx)	9.3ft L x 32.6ft W (2.8 m L x 9.9 m W)		Warm (2700K)	Warm (3000K)	Neutral (3500K)	Cool (4800K)	Daylight (6500K)
	6ft (1.8 m)	2.07Fc (22.3lx)	18.6ft L x 65.2ft W (5.7 m L x 19.9 m W)						
L-FLXCOB12-48RV-1 Tested									

See page 84 for part numbers and descriptions

# COB FlexTape®

24VDC

5.5W/ft.  
(18.1W/m)

420 Lumens  
per ft.  
(1386 per meter)



Chip on Board or "COB" FlexTape® is the latest advancement in tape lighting. With diodes directly mounted on a printed circuit board and a continuous fortified coating, this flexible, high density LED lighting strip creates our Luniform look without dark spots – no covers or filters needed!

## Features:

New generation of tape lighting

115° beam angle

Available in 2700K, 3000K, 3500K, 4800K or 6500K

Wattage: 5.5W/ft. – 16.4' (5 m) roll

Cuttable every 1-1/2" (38 mm)

High-density lighting

Can be used with Inflex extrusions (sold separately)

Indoor use only

## Typical Applications:

Store fixtures

Edge lighting

Backlighting

Accent lighting

Cove lighting

Toe kick

Soffit



## Dimensions:

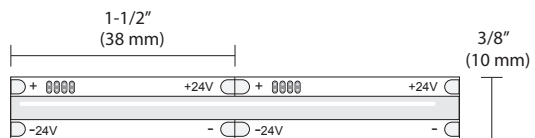

Encapsulated diodes are protected from splashes, dust and moisture.

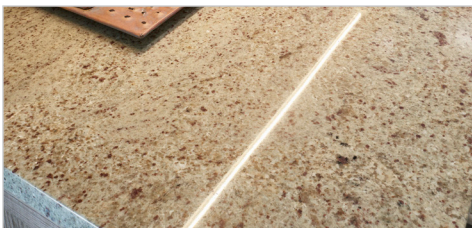

Luniform look without dark spots



Strong 300 LSE 3M™ adhesive backing



Cuttable every  
1-1/2"  
(38 mm)

Typical Setup:

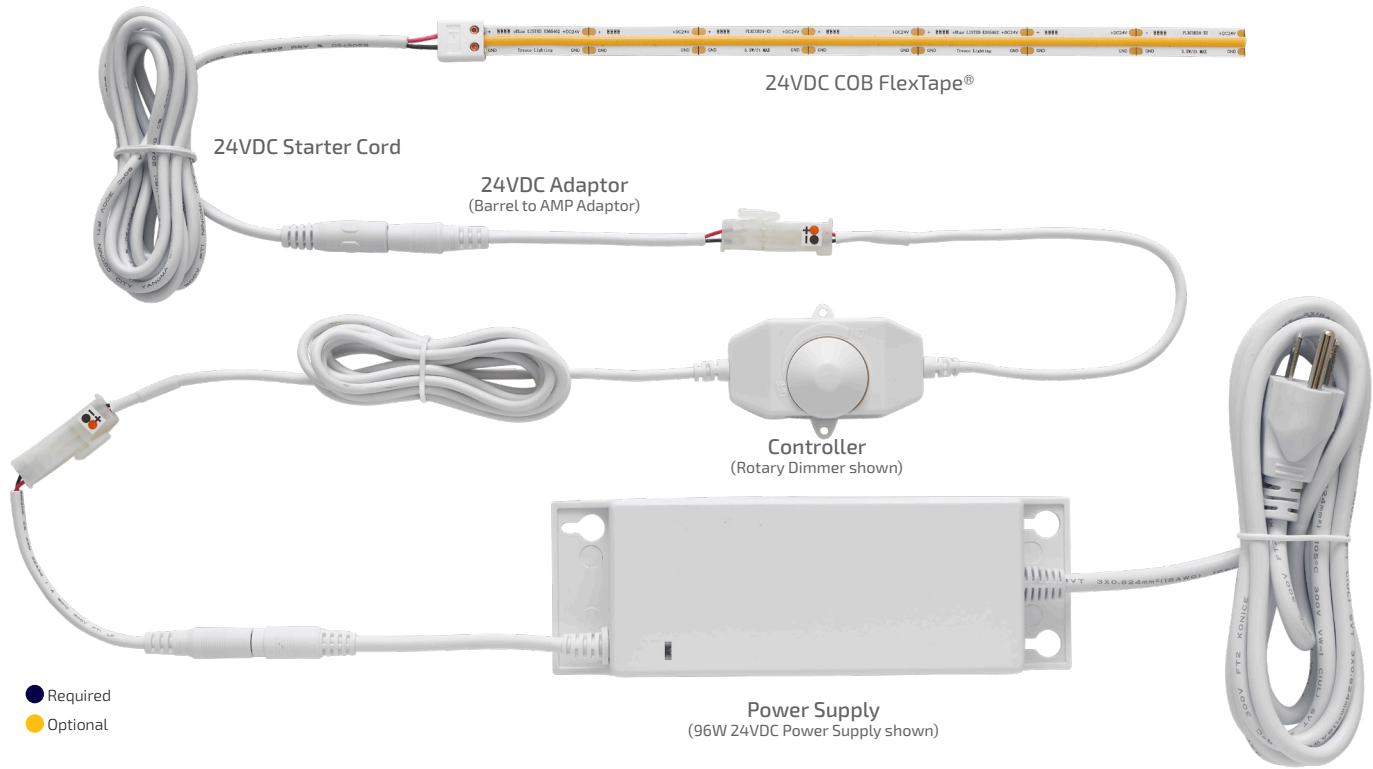

- Required
- Optional

Accessories:

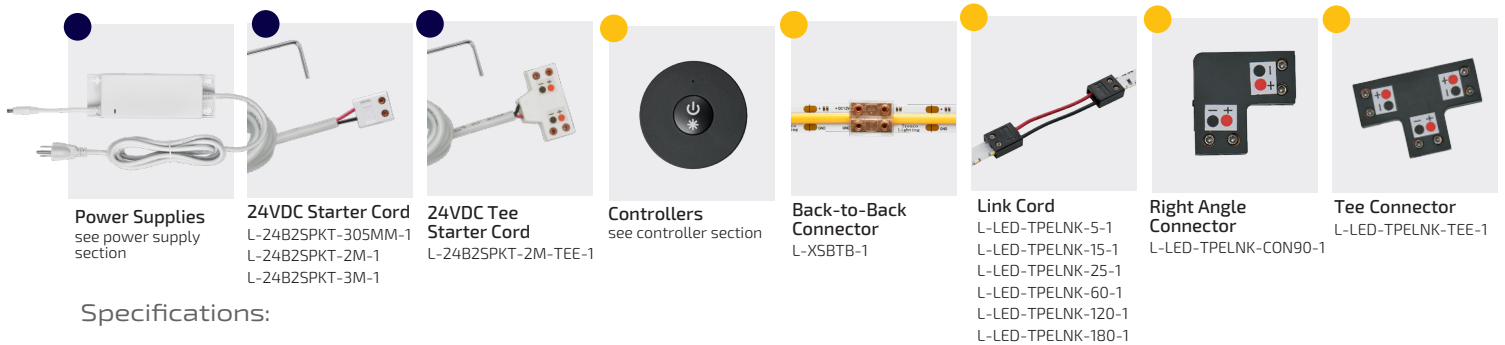

Specifications:

Wattage	Lumens	Efficacy (lm/W)	Input Voltage	Diode Life	Max Per Power Supply 96W	Max Continuous Run	Mounting	Warranty	Beam Angle																								
5.5W/ft. (18.1W/m)	420 per ft (1386 per m)	76.4	24VDC	50,000 Hours	16.4' (5 m)	16.4' (5 m)	Surface	5 year																									
Photometric Data					Color Temperature																												
	Height	Light Output	Beam Area																														
	1ft (.3m)	123Fc (1324lx)	3.1ft L x 8.5ft W (94m L x 2.6m W)																														
	3ft (.9m)	13.6Fc (146.3lx)	9.3ft L x 32.6ft W (2.9m L x 7.8m W)																														
	6ft (1.8m)	3.41Fc (36.7lx)	18.7ft L x 51.2ft W (5.7m L x 15.6m W)																														
L-FLXCOB24-48RU-1 Tested				<table border="0" style="width: 100%;"> <tr> <td style="text-align: center;">Warm White</td> <td style="text-align: center;">Warm to Neutral</td> <td style="text-align: center;">Cool White</td> <td style="text-align: center;">Daylight</td> <td colspan="2"></td> </tr> <tr> <td style="text-align: center;"></td> <td style="text-align: center;"></td> <td style="text-align: center;"></td> <td style="text-align: center;"></td> <td style="text-align: center;"></td> <td style="text-align: center;"></td> </tr> <tr> <td style="text-align: center;">2700K</td> <td style="text-align: center;">3000K</td> <td style="text-align: center;">3500K</td> <td style="text-align: center;">4800K</td> <td style="text-align: center;">5500K</td> <td style="text-align: center;">6500K</td> </tr> <tr> <td style="text-align: center;">▲ Warm (2700K)</td> <td style="text-align: center;">▲ Warm (3000K)</td> <td style="text-align: center;">▲ Neutral (3500K)</td> <td style="text-align: center;">▲ Cool (4800K)</td> <td colspan="2"></td> </tr> </table>						Warm White	Warm to Neutral	Cool White	Daylight									2700K	3000K	3500K	4800K	5500K	6500K	▲ Warm (2700K)	▲ Warm (3000K)	▲ Neutral (3500K)	▲ Cool (4800K)		
Warm White	Warm to Neutral	Cool White	Daylight																														
2700K	3000K	3500K	4800K	5500K	6500K																												
▲ Warm (2700K)	▲ Warm (3000K)	▲ Neutral (3500K)	▲ Cool (4800K)																														

See page 86 for part numbers and descriptions

# Single Color Tape

All product dimensions and specifications are subject to change without prior notice.

- Required
- Optional

## ● 12VDC FlexTape® 1.5W

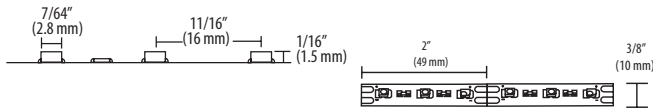
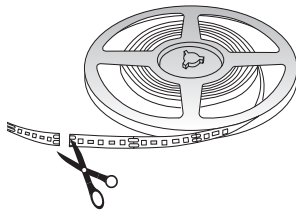

Part #	Description
L-LED-FLXTPE-WROLL-1	20' (6 m) 12VDC 2700K FlexTape® Roll
L-FLXTPE-30RS-1	20' (6 m) 12VDC 3000K FlexTape® Roll
L-LED-FLXTPE-NROLL-1	20' (6 m) 12VDC 3500K FlexTape® Roll
L-LED-FLXTPE-CROLL-1	20' (6 m) 12VDC 4800K FlexTape® Roll
L-LED-FLXTPE-DROLL-1	20' (6 m) 12VDC 6500K FlexTape® Roll
L-LED-FLXTPE-BROLL-1	20' (6 m) 12VDC Blue FlexTape® Roll
L-LED-FLXTPE-RROLL-1	20' (6 m) 12VDC Red FlexTape® Roll

Maximum continuous run is 20' (6 m). Maximum per power supply is 40' (12 m). Mounts with adhesive backing. Cuttable every 2" (49 mm). To be used on clean, smooth surfaces. Pressure must be applied for proper 3M™ tape adhesion.

## ● 12VDC FlexTape® 3W

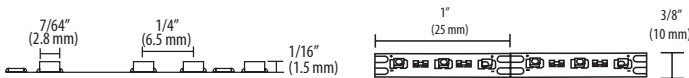
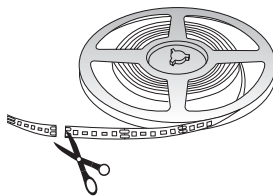

Part #	Description
L-LED-FLXTPE-WRHO-1	16.4' (5 m) 12VDC 2700K High Output FlexTape® Roll
L-FLXTPE-30RH-1	16.4' (5 m) 12VDC 3000K High Output FlexTape® Roll
L-LED-FLXTPE-NRHO-1	16.4' (5 m) 12VDC 3500K High Output FlexTape® Roll
L-LED-FLXTPE-CRHO-1	16.4' (5 m) 12VDC 4800K High Output FlexTape® Roll
L-LED-FLXTPE-DRHO-1	16.4' (5 m) 12VDC 6500K High Output FlexTape® Roll
L-LED-FLXTPE-RRHO-1	16.4' (5 m) 12VDC Red High Output FlexTape® Roll
L-LED-FLXTPE-BRHO-1	16.4' (5 m) 12VDC Blue High Output FlexTape® Roll

Maximum continuous run is 16.4' (5 m). Maximum per power supply is 20' (6 m). Mounts with adhesive backing. Cuttable every 1" (25 mm). To be used on clean, smooth surfaces. Pressure must be applied for proper 3M™ tape adhesion.

## ● 12VDC FlexTape® 4.4W

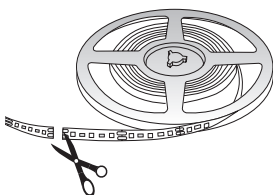

Part #	Description
L-FLXTPE-WRV-1	13' (4 m) 12VDC 2700K High Output FlexTape® Roll
L-FLXTPE-30RV-1	13' (4 m) 12VDC 3000K High Output FlexTape® Roll
L-FLXTPE-NRV-1	13' (4 m) 12VDC 3500K High Output FlexTape® Roll
L-FLXTPE-CRV-1	13' (4 m) 12VDC 4800K High Output FlexTape® Roll
L-FLXTPE-DRV-1	13' (4 m) 12VDC 6500K High Output FlexTape® Roll

Maximum continuous run is 13' (4 m). Maximum per power supply is 13' (4 m). Mounts with adhesive backing. Cuttable every 2" (49 mm). To be used on clean, smooth surfaces. Pressure must be applied for proper 3M™ tape adhesion.

## ● 12VDC FlexTape® 5.5W

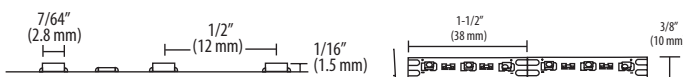
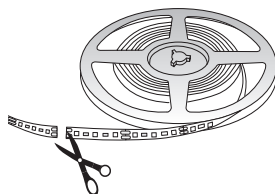

Part #	Description
L-FLXTPE-27RU-1	10' (3 m) 12VDC 2700K Ultra Output FlexTape® Roll
L-FLXTPE-30RU-1	10' (3 m) 12VDC 3000K Ultra Output FlexTape® Roll
L-FLXTPE-35RU-1	10' (3 m) 12VDC 3500K Ultra Output FlexTape® Roll
L-FLXTPE-48RU-1	10' (3 m) 12VDC 4800K Ultra Output FlexTape® Roll
L-FLXTPE-65RU-1	10' (3 m) 12VDC 6500K Ultra Output FlexTape® Roll

Maximum continuous run is 10' (3 m). Maximum per power supply is 10' (3 m). Mounts with adhesive backing. Cuttable every 1-1/2" (38 mm). To be used on clean, smooth surfaces. Pressure must be applied for proper 3M™ tape adhesion. **MUST USE PROPER HEAT SINK (i.e. Inflex Aluminum Extrusions)**



# Single Color Tape

All product dimensions and specifications are subject to change without prior notice.

- Required
- Optional

## ● 12VDC Edge Emitting FlexTape®

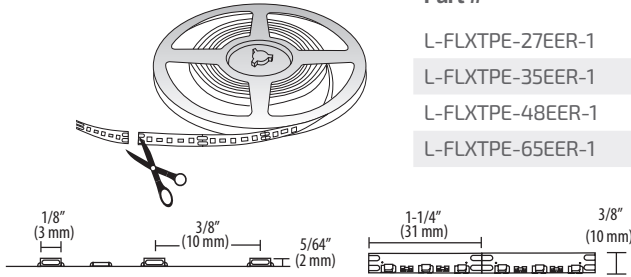

### Part #

Part #	Description
L-FLXTPE-27EER-1	16.4' (5 m) 12VDC 2700K Edge Emitting FlexTape® LED Roll
L-FLXTPE-35EER-1	16.4' (5 m) 12VDC 3500K Edge Emitting FlexTape® LED Roll
L-FLXTPE-48EER-1	16.4' (5 m) 12VDC 4800K Edge Emitting FlexTape® LED Roll
L-FLXTPE-65EER-1	16.4' (5 m) 12VDC 6500K Edge Emitting FlexTape® LED Roll

Maximum continuous run is 16.4' (5 m). Maximum per power supply is 24' (7 m). Mounts with adhesive backing. Cuttable every 1-1/4" (31 mm). To be used on clean, smooth surfaces. Pressure must be applied for proper 3M™ tape adhesion.

## ● 12VDC EquiLine Tape LED 1.5W

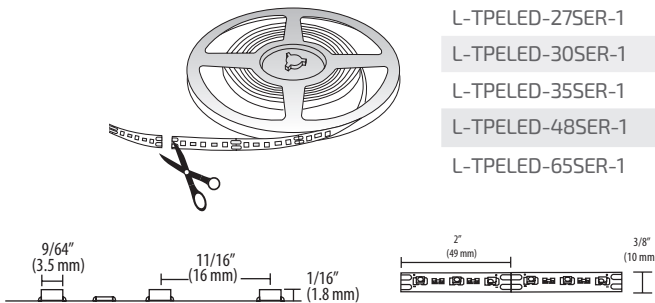

### Part #

Part #	Description
L-TPELED-27SER-1	EquiLine 20' (6 m) Roll Tape LED 2700K
L-TPELED-30SER-1	EquiLine 20' (6 m) Roll Tape LED 3000K
L-TPELED-35SER-1	EquiLine 20' (6 m) Roll Tape LED 3500K
L-TPELED-48SER-1	EquiLine 20' (6 m) Roll Tape LED 4800K
L-TPELED-65SER-1	EquiLine 20' (6 m) Roll Tape LED 6500K

Maximum continuous run is 20' (6 m). Maximum per power supply is 40' (12 m). Mounts with adhesive backing. Cuttable every 2" (49 mm). To be used on clean, smooth surfaces. Pressure must be applied for proper 3M™ tape adhesion.

## ● 12VDC EquiLine Tape LED 3W

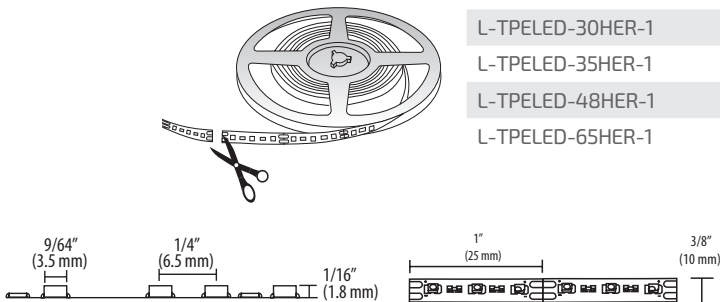

### Part #

Part #	Description
L-TPELED-27HER-1	EquiLine 16.4' (5 m) Roll Tape LED 2700K
L-TPELED-30HER-1	EquiLine 16.4' (5 m) Roll Tape LED 3000K
L-TPELED-35HER-1	EquiLine 16.4' (5 m) Roll Tape LED 3500K
L-TPELED-48HER-1	EquiLine 16.4' (5 m) Roll Tape LED 4800K
L-TPELED-65HER-1	EquiLine 16.4' (5 m) Roll Tape LED 6500K

Maximum continuous run is 16.4' (5 m). Maximum per power supply is 20' (6 m). Mounts with adhesive backing. Cuttable every 1" (25 mm). To be used on clean, smooth surfaces. Pressure must be applied for proper 3M™ tape adhesion.

## ● 12VDC EquiLine Tape LED 4.4W

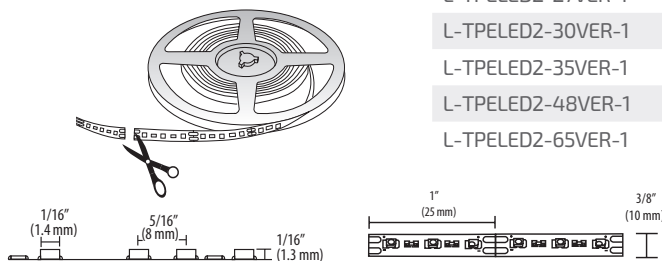

### Part #

Part #	Description
L-TPELED2-27VER-1	EquiLine 13' (3.96 m) Roll Tape LED 2700K
L-TPELED2-30VER-1	EquiLine 13' (3.96 m) Roll Tape LED 3000K
L-TPELED2-35VER-1	EquiLine 13' (3.96 m) Roll Tape LED 3500K
L-TPELED2-48VER-1	EquiLine 13' (3.96 m) Roll Tape LED 4800K
L-TPELED2-65VER-1	EquiLine 13' (3.96 m) Roll Tape LED 6500K

Maximum continuous run is 13' (3.96 m). Maximum per power supply is 13' (3.96 m). Mounts with adhesive backing. Cuttable every 1" (25 mm). To be used on clean, smooth surfaces. Pressure must be applied for proper 3M™ tape adhesion.

# Single Color Tape

- Required
- Optional

## ● 12VDC COB FlexTape® 4.4W

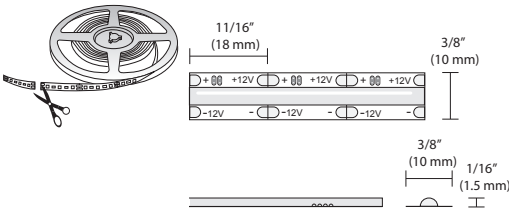

Part #	Description
L-FLXCOB12-27RV-1	12VDC 4.4W/FT 2700K COB FlexTape® 13' (4 m) Roll
L-FLXCOB12-30RV-1	12VDC 4.4W/FT 3000K COB FlexTape® 13' (4 m) Roll
L-FLXCOB12-35RV-1	12VDC 4.4W/FT 3500K COB FlexTape® 13' (4 m) Roll
L-FLXCOB12-48RV-1	12VDC 4.4W/FT 4800K COB FlexTape® 13' (4 m) Roll
L-FLXCOB12-65RV-1	12VDC 4.4W/FT 6500K COB FlexTape® 13' (4 m) Roll

Maximum continuous run is 13' (4 m). Maximum per power supply is 13' (4 m). Mounts with adhesive backing. Cuttable every 11/16" (18 mm). To be used on clean, smooth surfaces. Pressure must be applied for proper 3M™ tape adhesion.

## ● 12VDC Power Supplies



Part #	Description
L-DC-SLELT30-1	30W 12VDC Power Supply w/6 Snap Mounting Block*
L-DC-SLELT60-1	60W 12VDC Power Supply w/6 Snap Mounting Block*
L-DC-ELT6WP-CON-1	6W 12VDC Wall Mount Power Supply w/3 Snap Block*
L-DC-ELT15WP-CON-1	15W 12VDC Wall Mount Power Supply w/6 Snap Block*
L-DC-EQ30-1	30W 12VDC Equiline Power Supply w/6 Snap Block*
L-DC-EQ60-1	60W 12VDC Equiline Power Supply w/6 Snap Block*
L-DCE30D-CON-1	30W 12VDC Hardwire Dimmable LED Power Supply†
L-DCE60D-CON-1	60W 12VDC Hardwire Dimmable LED Power Supply†
L-12DCH60X1-1	60W 12VDC Commercial/Industrial Metal Hardwire Dimmable Power Supply§
L-12DCH60X3-1	180W 12VDC Commercial/Industrial Metal Hardwire Dimmable Power Supply§
L-12DCH60X5-120-277V-1	300W 12VDC Commercial Hardwire 0-10V Dimmable Power Supply

\* Dimmable on trailing edge (12VDC side). Mounting block and power cord are included.

† Dimmable by LED line voltage (120V) wall dimmers. Mounting block included.

§ Dimmable by LED line voltage (120V) wall dimmers. Mounting block not included

All hardwire power supplies require an electrician for install.

## ● 12VDC Starter Cord for Single Color Tape

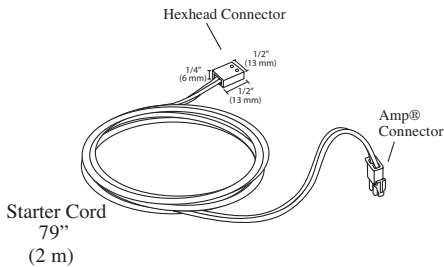

Part #	Description
L-LED-TPEPKT-2M-1	2 m (79") FlexTape® Straight Starter Lead
L-TPEPKT-2IN-1	50 mm (2") FlexTape® Straight Starter Lead

## ● 12VDC Tee Starter Cord for Single Color Tape

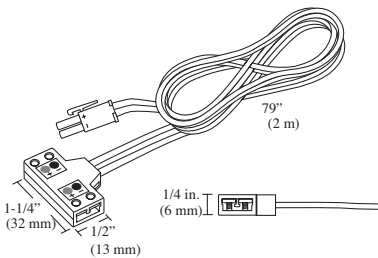

Part #	Description
L-LED-TPEPKT-2M-TEE-1	2 m (79") FlexTape® Tee Starter Lead

## ● 12/24VDC Tee Connector for Single Color Tape

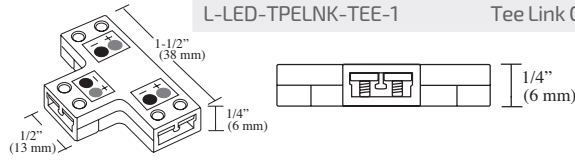

Part #	Description
L-LED-TPELNK-TEE-1	Tee Link Connector

## ● 12/24VDC Right Angle Connector for Single Color Tape

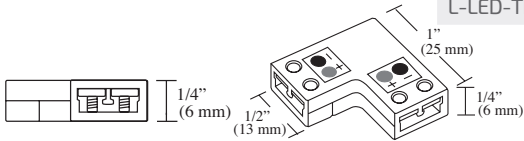

Part #	Description
L-LED-TPELNK-CON90-1	90° Link Connector

## ● 12/24VDC Link Cord for Single Color Tape



Positive and negative contacts on FlexTape® and FlexConnects should match-up to maintain proper polarity.

Part #	Description
L-LED-TPELNK-5-1	5 cm (2") FlexTape® Link Cord
L-LED-TPELNK-15-1	15 cm (6") FlexTape® Link Cord
L-LED-TPELNK-25-1	25 cm (10") FlexTape® Link Cord
L-LED-TPELNK-60-1	60 cm (24") FlexTape® Link Cord
L-LED-TPELNK-120-1	120 cm (48") FlexTape® Link Cord
L-LED-TPELNK-180-1	180 cm (72") FlexTape® Link Cord

## ● 12VDC Back-to-Back Connector for Single Color FlexTape®

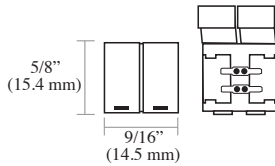

Part #	Description
L-TPELNK-BTB-1	Back-to-Back Connector

To be used with non-COB single color tapes.

## ● 12/24VDC Back-to-Back Connector for COB

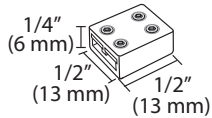

Part #	Description
L-XSBTB-1	10 mm, 2 Position Back-to-Back Connector, Clear



# Single Color Tape

All product dimensions and specifications are subject to change without prior notice.

- Required
- Optional

## ● 24VDC COB FlexTape® 5.5W

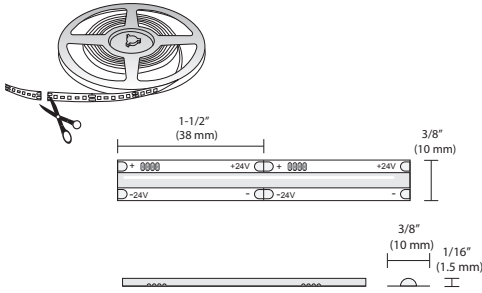

Part #	Description
L-FLXCOB24-27RU-1	24VDC 5.5W/FT 2700K COB FlexTape® 16.4' (5 m) Roll
L-FLXCOB24-30RU-1	24VDC 5.5W/FT 3000K COB FlexTape® 16.4' (5 m) Roll
L-FLXCOB24-35RU-1	24VDC 5.5W/FT 3500K COB FlexTape® 16.4' (5 m) Roll
L-FLXCOB24-48RU-1	24VDC 5.5W/FT 4800K COB FlexTape® 16.4' (5 m) Roll
L-FLXCOB24-65RU-1	24VDC 5.5W/FT 6500K COB FlexTape® 16.4' (5 m) Roll

Maximum continuous run is 16.4' (5 m). Maximum per power supply is 16.4' (5 m). Mounts with adhesive backing. Cuttable every 1-1/2" (38 mm). To be used on clean, smooth surfaces. Pressure must be applied for proper 3M™ tape adhesion. **MUST USE PROPER HEAT SINK (i.e. Infinex Aluminum Extrusions)**

## ● 24VDC Power Supplies



Part #	Description
L-24DCELT96-1	96W 24VDC Power Supply w/ 5 Barrel Out - White†
L-24DCELT48-BL-1	48W 24VDC Power Supply w/ 5 Barrel Out - Black†
L-24DCELT15WP-1	15W 24VDC Wall Mount Power Supply w/ Snap Connector*†
L-24DCH96X1-1	96W 24VDC Dimmable Hardwire Power Supply*§
L-24DCH96X3-1	288W 24VDC Dimmable Hardwire Power Supply*§
L-24DCH96X4-120-277V-1	384W 24VDC Commercial Hardwire 0-10V Dimmable Power Supply
L-1BRL5-1	Extra 5 Output Barrel Splice

\*Does not come with 5 Output Barrel Splice  
 †Dimmable on trailing edge (24VDC side)  
 §Dimmable by LED line voltage (120V) wall dimmers

## ● 24VDC Starter Cord for COB

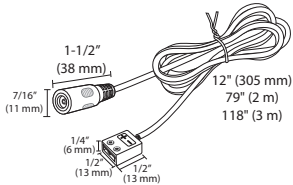

Part #	Description
L-24B2SPKT-305MM-1	305 mm (12") 24VDC FlexTape® Barrel/2 Screw Trml Starter Lead, White
L-24B2SPKT-2M-1	2 m (79") 24VDC FlexTape® Barrel/2 Screw Trml Starter Lead, White
L-24B2SPKT-3M-1	3 m (118") 24VDC FlexTape® Barrel/2 Screw Trml Starter Lead, White

## ● 24VDC Tee Starter Cord for COB

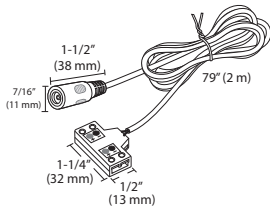

Part #	Description
L-24B2SPKT-2M-TEE-1	2 m (79") 24VDC FlexTape® Barrel/2 Screw Trml Tee Starter Lead, White

## ● 24VDC Extension Lead

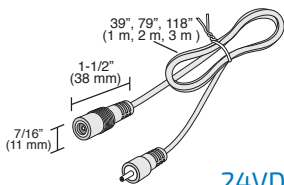

Part #	Description
L-24BBEXT-1M-1	1 m (39") 24VDC ML/FML Barrel Extension, White
L-24BBEXT-2M-1	2 m (79") 24VDC ML/FML Barrel Extension, White
L-24BBEXT-3M-1	3 m (119") 24VDC ML/FML Barrel Extension, White

24VDC COB FLEXTAPE® USES STANDARD FLEXTAPE® LINK CORDS, TEE CONNECTOR AND 90-DEGREE CONNECTOR. SEE PAGE 85.



COMPONENTS: POWER SUPPLIES, CONTROLLERS AND MORE SEE PAGE 150.



Silicone

12VDC

24VDC

NEW!

# Side-Emitting Neoloop

12VDC

3W/ft.  
(9.8W/m)

100 Lumens  
per ft.  
(328 per meter)



Bold lighting for bright applications, achieve consistent, seamless illumination from start to finish with Neoloop, flexible silicone LED lighting. Shatterproof and watertight, side-emitting Neoloop illuminates from the side and bends on a horizontal axis, a perfect solution for adding light to dark millwork, creating unique wall designs, outlining commercial logos and more.

### Features:

Durable, flexible silicone construction with a flat illuminated side bendable on the horizontal axis

3W/ft. Luniform output for continuous illumination

Available in (5) color temperatures: 2700K, 3000K, 3500K, 4800K, 6500K

Sold in 16.4' (5 m) rolls and cuttable every 1" (25 mm)

Linkable with DIY connectors - no soldering required!

79" (2 m) Starter Cords are molded on each end for easy installation

Groove for recess mounting or surface mount with U-Clips in indoor, outdoor\*, damp and wet\* locations

\*When used with factory-installed inputs

### Typical Applications:

Millwork

Accent lighting

Furniture

Shelving

Closets (UL listed for use within closet storage spaces)



### Available Finishes:



### Dimensions:

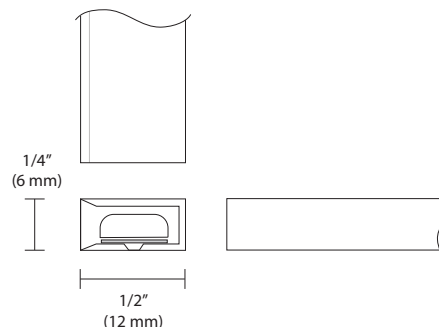

Flat illuminated side bendable on the horizontal axis, IP65 rated

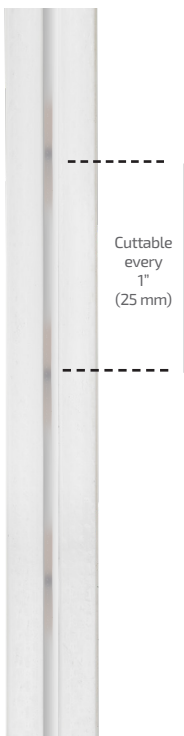

Cuttable every 1" (25 mm)



Cuttable every 1" (25 mm)



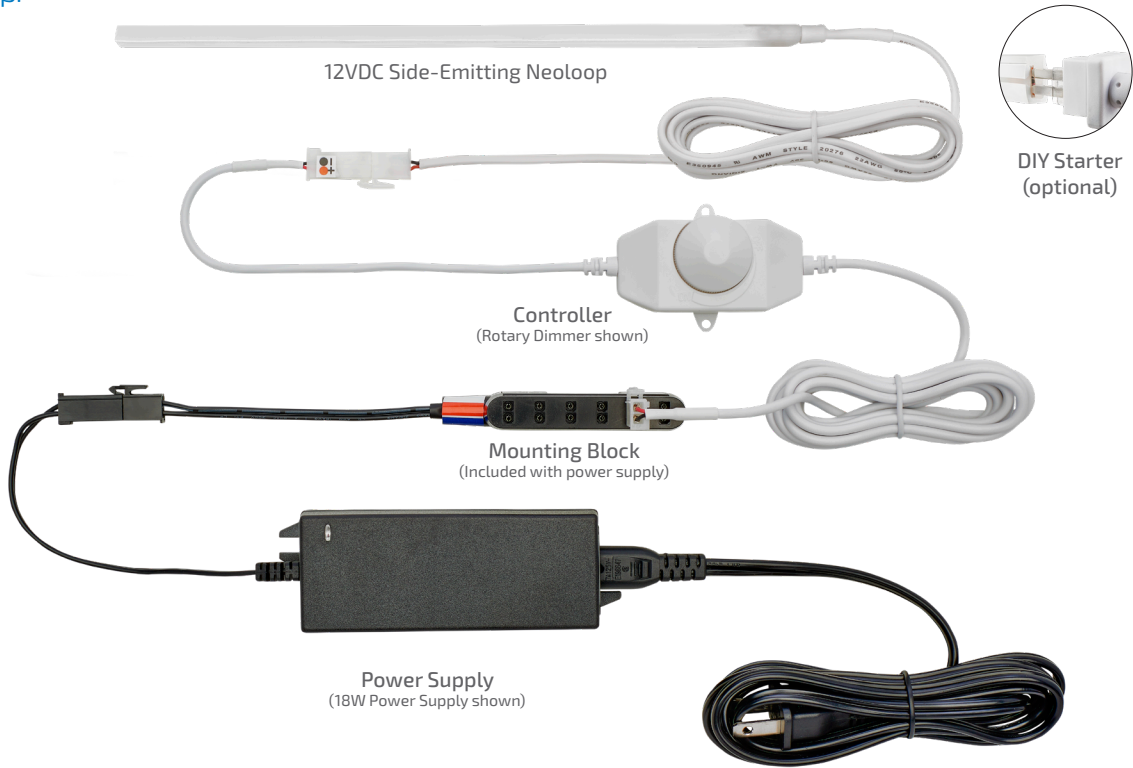

Easily press into a 6 mm W x 12 mm D groove for recess mounting or surface mount with U-Clips

Typical Setup:



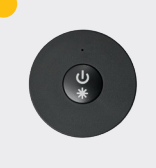
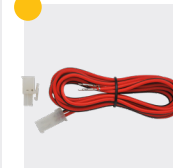
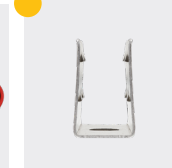
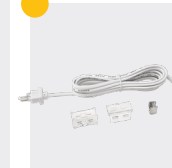

- Required
- Optional

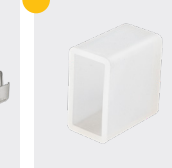
Accessories:

 <p><b>Power Supplies</b> see power supply section</p>	 <p><b>Controllers</b> See controller section</p>	 <p><b>Starter Cord Extensions</b> L-LED-LINKD-8-1 L-LED-LINKD-15-1 L-LED-LINKD-25-1 L-LED-LINKD-60-1 L-LED-LINKD-120-1 L-LED-LINKD-180-1 L-LED-LINKD-245-1</p>	 <p><b>U-Clips</b> L-N1-UCLP-1</p>	 <p><b>DIY Starter Cord</b> L-N1-12PKT-2M-1</p>	 <p><b>DIY Link Cords</b> L-N1-LNK25-1 L-N1-LNK60-1 L-N1-LNK120-1 L-N1-LNK180-1</p>	 <p><b>DIY Back-to-Back Connector</b> L-N1-BTB-1</p>	 <p><b>DIY End Cap</b> L-N1-ENDCAP-1</p>
---	---	---	--	---	---	--	--

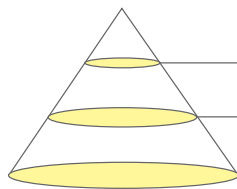
Specifications:

Wattage	Lumens	Efficacy (lm/W)	Input Voltage	Diode Life	CRI	Bend Diameter	Bend Axis	Max Per 60W Power Supply	Mounting	Warranty	Beam Angle
3W/ft (9.8W/m)	100 per ft. (328 per m)	33.3	12VDC	50,000 Hours	>90	4" (100 mm)	Horizontal	20' (7.3 m)	Recess/ Surface	5 Year	
Photometric Data							Color Temperature				
		Height	Light Output	Beam Area							
		1ft (.3 m)	34.0Fc (366lx)	3ft L x 2.9ft W (9 m L x .9 m W)							
		3ft (.9 m)	3.78Fc (40.7lx)	8.9ft L x 8.6ft W (2.7 m L x 2.6 m W)							
6ft (1.8 m)	0.95Fc (10.2lx)	17.9ft L x 17.1ft W (5.5 m L x 5.2 m W)									
						Color Temperature					
											
						Warm White (2700K)   Warm (3000K)   Neutral (3500K)   Cool (4800K)   Daylight (6500K)					
L-N1-12V3WM-48K-5M-1 Tested											

See page 96 for part numbers and descriptions



**NEW!**

# Top-Emitting Neoloop

12VDC

**3W/ft.**  
(9.8W/m)

**200 Lumens**  
per ft.  
(656 per meter)



Bold lighting for bright applications, achieve consistent, seamless illumination from start to finish with Neoloop, flexible silicone LED lighting. Shatterproof and watertight, top-emitting Neoloop illuminates from a curved top and bends on a vertical axis, ideal for architectural accents such as under countertops, soffits or toe kick lighting.

### Features:

- Durable, flexible silicone construction with a curved illuminated top bendable on the vertical axis
- 3W/ft. Luniform output for continuous illumination
- Available in (5) color temperatures: 2700K, 3000K, 3500K, 4800K, 6500K
- Sold in 16.4' (5 m) rolls and cuttable every 1" (25 mm)
- Linkable with DIY connectors - no soldering required!
- 79" (2 m) Starter Cords are molded on each end for easy installation
- Groove for recess mounting or surface mount with U-Clips in indoor, outdoor\*, damp and wet\* locations

\*When used with factory-installed inputs

### Typical Applications:

- Soffit lighting
- Toe Kick lighting
- Cove lighting
- Stairways
- Patios/Decks/Pathways
- Accent lighting
- Store fixtures



### Available Finishes:

White (WH)

### Dimensions:

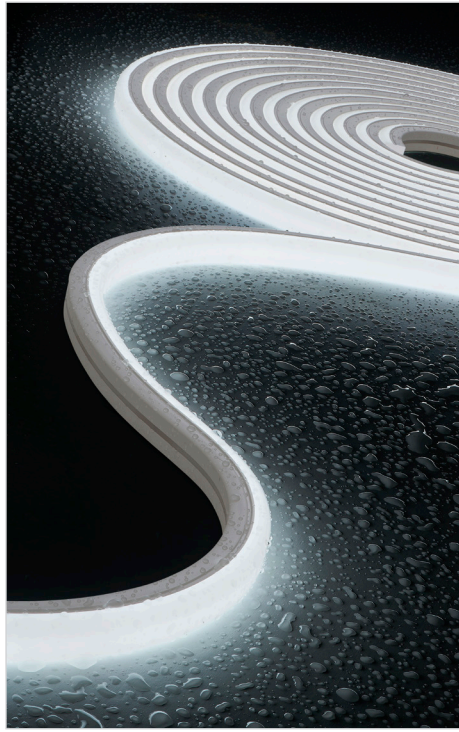
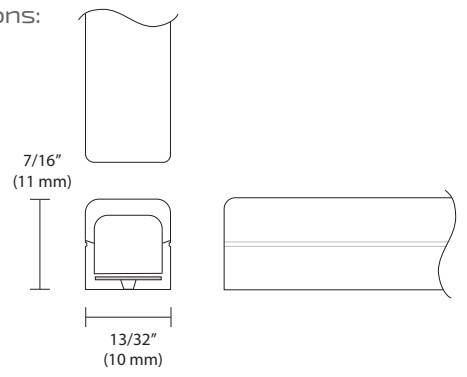

Curved illuminated top bendable on the vertical axis, IP65 rated

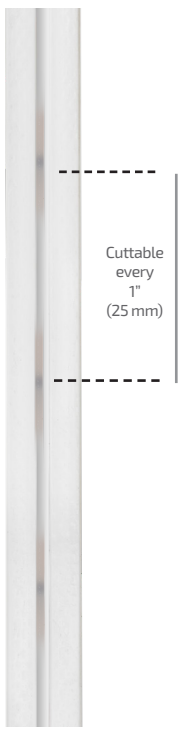

Cuttable every 1" (25 mm)



Cuttable every 1" (25 mm)







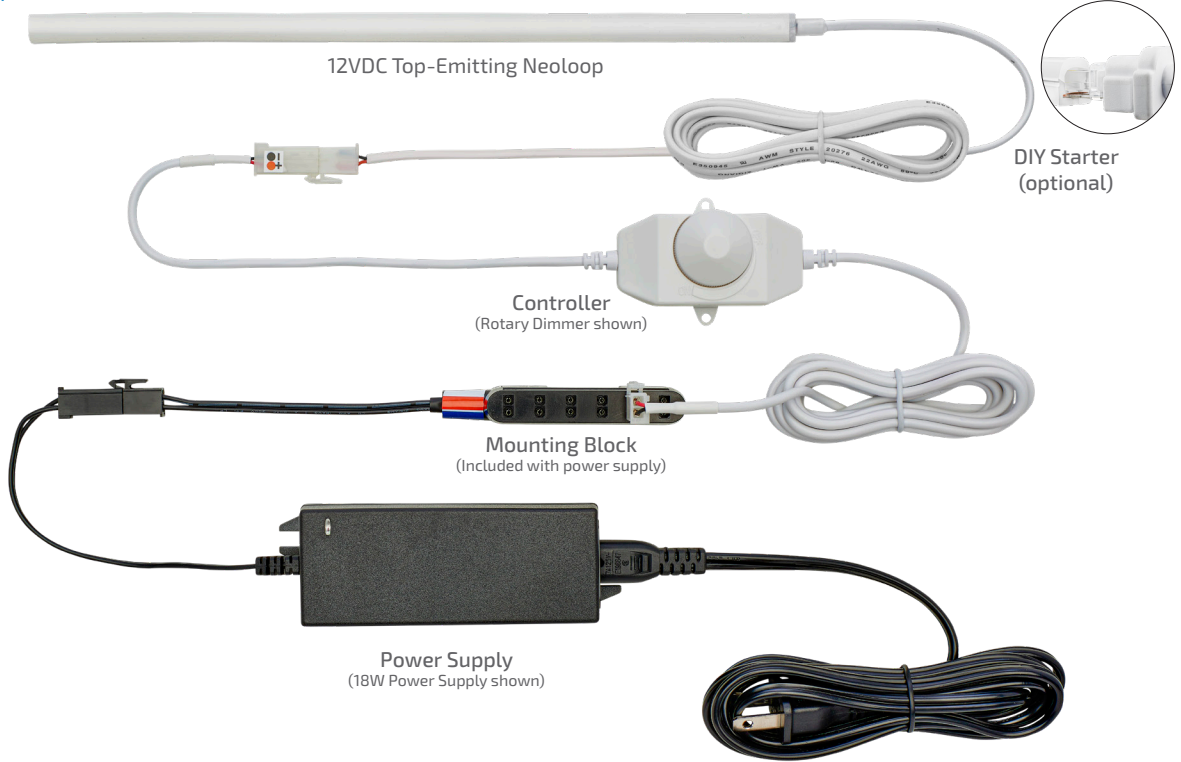

DIY accessories feature distinctive plastic teeth to ensure secure and reliable connections



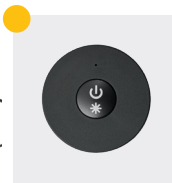



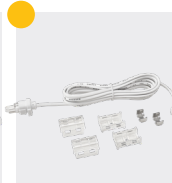
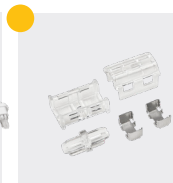





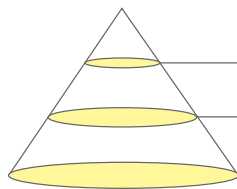

Typical Setup:



Accessories:

							
<b>Power Supplies</b> See power supply section	<b>Controllers</b> See controller section	<b>Starter Cord Extensions</b> L-LED-LINKD-8-1 L-LED-LINKD-15-1 L-LED-LINKD-25-1 L-LED-LINKD-60-1 L-LED-LINKD-120-1 L-LED-LINKD-180-1 L-LED-LINKD-245-1	<b>U-Clips</b> L-N2-UCLP-1	<b>DIY Starter Cord</b> L-N2-12PKT-2M-1	<b>DIY Link Cords</b> L-N2-LNK25-1 L-N2-LNK60-1 L-N2-LNK120-1 L-N2-LNK180-1	<b>DIY Back-to-Back Connector</b> L-N2-BTB-1	<b>DIY End Cap</b> L-N2-ENDCAP-1

Specifications:

Wattage	Lumens	Efficacy (lm/W)	Input Voltage	Diode Life	CRI	Bend Diameter	Bend Axis	Max Per 60W Power Supply	Mounting	Warranty	Beam Angle																							
3W/ft (9.8W/m)	200 per ft. (656 per m)	66.7	12VDC	50,000 Hours	>90	4" (100 mm)	Vertical	20' (7.3 m)	Recess/Surface	5 Year																								
Photometric Data						Color Temperature																												
			<table border="1"> <thead> <tr> <th>Height</th> <th>Light Output</th> <th>Beam Area</th> </tr> </thead> <tbody> <tr> <td>1ft (.3 m)</td> <td>43.2Fc (465lx)</td> <td>4.1ft L x 2.8ft W (1.2 m L x .85 m W)</td> </tr> <tr> <td>3ft (.9 m)</td> <td>4.8Fc (51.6lx)</td> <td>12.3ft L x 8.3ft W (3.7 m L x 2.5 m W)</td> </tr> <tr> <td>6ft (1.8 m)</td> <td>1.2Fc (12.9lx)</td> <td>24.6ft L x 16.7ft W (7.5 m L x 5.1 m W)</td> </tr> </tbody> </table>	Height	Light Output	Beam Area	1ft (.3 m)	43.2Fc (465lx)	4.1ft L x 2.8ft W (1.2 m L x .85 m W)	3ft (.9 m)	4.8Fc (51.6lx)	12.3ft L x 8.3ft W (3.7 m L x 2.5 m W)	6ft (1.8 m)	1.2Fc (12.9lx)	24.6ft L x 16.7ft W (7.5 m L x 5.1 m W)	<table border="1"> <thead> <tr> <th>Warm White</th> <th>Warm to Neutral</th> <th>Cool White</th> <th>Daylight</th> </tr> </thead> <tbody> <tr> <td></td> <td></td> <td></td> <td></td> </tr> <tr> <td>2700K</td> <td>3000K</td> <td>3500K</td> <td>6500K</td> </tr> <tr> <td>▲ Warm (2700K)</td> <td>▲ Warm (3000K)</td> <td>▲ Neutral (3500K)</td> <td>▲ Daylight (6500K)</td> </tr> </tbody> </table>			Warm White	Warm to Neutral	Cool White	Daylight					2700K	3000K	3500K	6500K	▲ Warm (2700K)	▲ Warm (3000K)	▲ Neutral (3500K)	▲ Daylight (6500K)
Height	Light Output	Beam Area																																
1ft (.3 m)	43.2Fc (465lx)	4.1ft L x 2.8ft W (1.2 m L x .85 m W)																																
3ft (.9 m)	4.8Fc (51.6lx)	12.3ft L x 8.3ft W (3.7 m L x 2.5 m W)																																
6ft (1.8 m)	1.2Fc (12.9lx)	24.6ft L x 16.7ft W (7.5 m L x 5.1 m W)																																
Warm White	Warm to Neutral	Cool White	Daylight																															
																																		
2700K	3000K	3500K	6500K																															
▲ Warm (2700K)	▲ Warm (3000K)	▲ Neutral (3500K)	▲ Daylight (6500K)																															
L-N2-12V3WM-48K-5M-1 Tested																																		

See page 96 for part numbers and descriptions

**NEW!** **Side-Emitting Neoloop** 24V DC

<b>3W/ft.</b> (9.8W/m)	<b>100 Lumens per ft.</b> (328 per meter)	 <b>110°</b>
---------------------------	--	--

Bold lighting for bright applications, achieve consistent, seamless illumination from start to finish with Neoloop, flexible silicone LED lighting. Shatterproof and watertight, side-emitting Neoloop illuminates from the side and bends on a horizontal axis, a perfect solution for adding light to dark millwork, creating unique wall designs, outlining commercial logos and more.

**Features:**

- Durable, flexible silicone construction with a flat illuminated side bendable on the horizontal axis
  - 3W/ft. Uniform output for continuous illumination
  - Available in (5) color temperatures: 2700K, 3000K, 3500K, 4800K, 6500K
  - Sold in 26.25' (8 m) rolls and cuttable every 1-31/32" (50 mm)
  - Linkable with DIY connectors - no soldering required!
  - 79" (2 m) Starter Cords are molded on each end for easy installation
  - Groove for recess mounting or surface mount with U-Clips in indoor, outdoor\*, damp and wet\* locations
- \*When used with factory-installed inputs

**Typical Applications:**

- Millwork
- Accent lighting
- Furniture
- Shelving
- Closets (UL listed for use within closet storage spaces)



**Available Finishes:**



**Dimensions:**

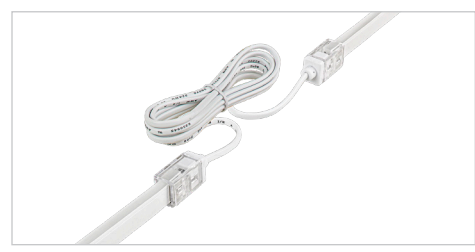
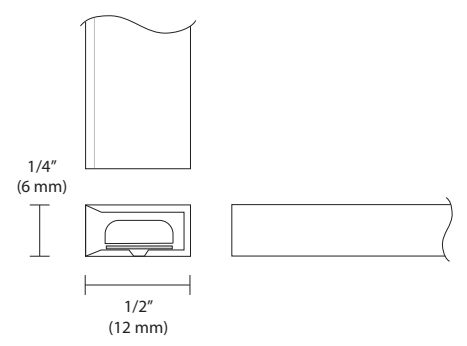

Typical Setup:

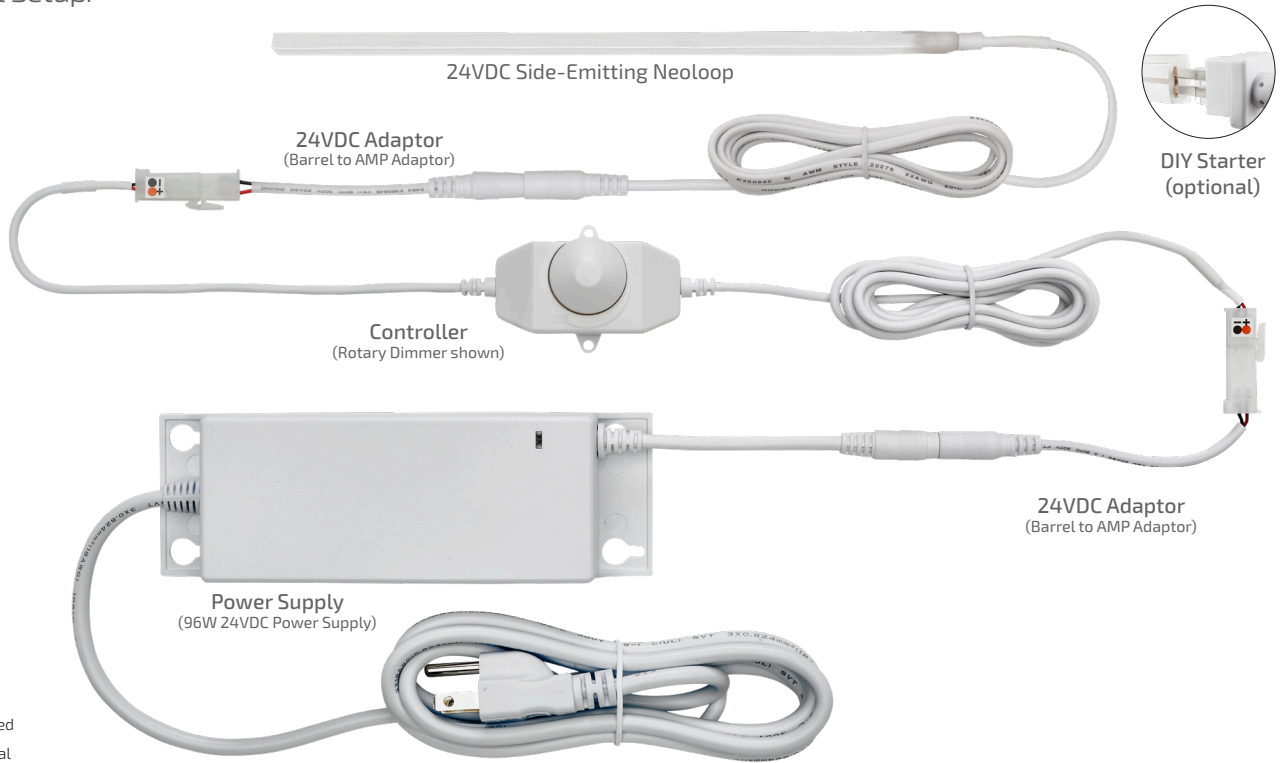

- Required
- Optional

Accessories:

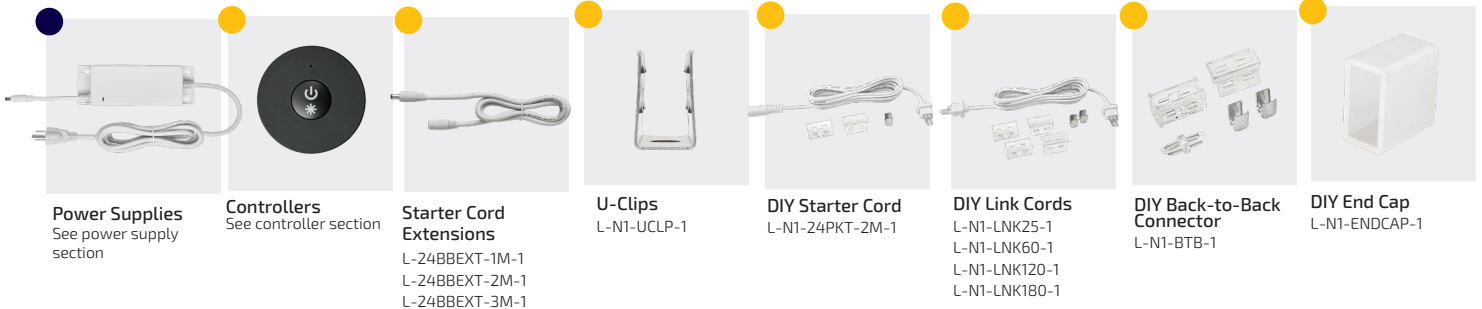

Specifications:

Wattage	Lumens	Efficacy (lm/W)	Input Voltage	Diode Life	CRI	Bend Diameter	Bend Axis	Max Per 96W Power Supply	Mounting	Warranty	Beam Angle
3W/ft (9.8W/m)	100 per ft. (328 per m)	33.3	24VDC	50,000 Hours	>90	4" (100 mm)	Horizontal	26.25' (8 m)	Recess/Surface	5 Year	110°
Photometric Data							Color Temperature				
	Height	Light Output	Beam Area								
	1ft (.3 m)	34.0Fc (366lx)	3ft L x 2.9ft W (9 m L x 9 m W)								
	3ft (.9 m)	3.78Fc (40.7lx)	8.9ft L x 8.6ft W (2.7 m L x 2.6 m W)								
6ft (1.8 m)	0.95Fc (10.2lx)	17.9ft L x 17.1ft W (5.5 m L x 5.2 m W)									
L-N1-24V3WM-48K-8M-1 Tested											

See page 96 for part numbers and descriptions

NEW!

# Top-Emitting Neoloop

24VDC

3W/ft.  
(9.8W/m)

200 Lumens  
per ft.  
(656 per meter)



Bold lighting for bright applications, achieve consistent, seamless illumination from start to finish with Neoloop, flexible silicone LED lighting. Shatterproof and watertight, top-emitting Neoloop illuminates from a curved top and bends on a vertical axis, ideal for architectural accents such as under countertops, soffits or toe kick lighting.

### Features:

Durable, flexible silicone construction with a curved illuminated top bendable on the vertical axis

3W/ft. Uniform output for continuous illumination

Available in (5) color temperatures: 2700K, 3000K, 3500K, 4800K, 6500K

Sold in 26.25' (8 m) rolls and cuttable every 1-31/32" (50 mm)

Linkable with DIY connectors - no soldering required!

79" (2 m) Starter Cords are molded on each end for easy installation

Groove for recess mounting or surface mount with U-Clips in indoor, outdoor\*, damp\* and wet\* locations

\*When used with factory-installed inputs

### Typical Applications:

Soffit lighting

Toe Kick lighting

Cove lighting

Stairways

Patios/Decks/Pathways

Accent lighting

Store fixtures



### Available Finishes:



White (WH)

### Dimensions:

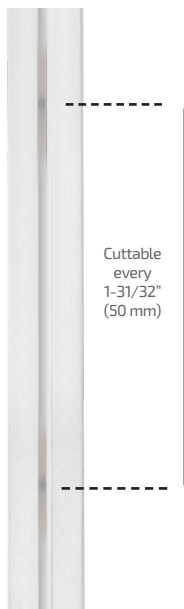
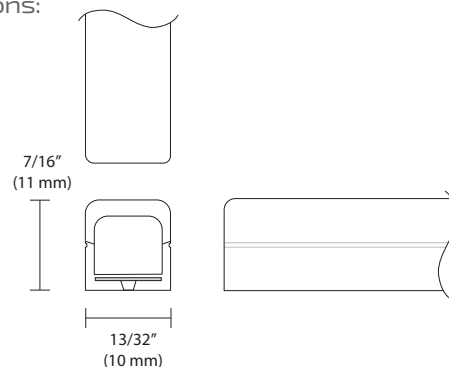

Cuttable every 1-31/32" (50 mm)



Uniform output for continuous illumination

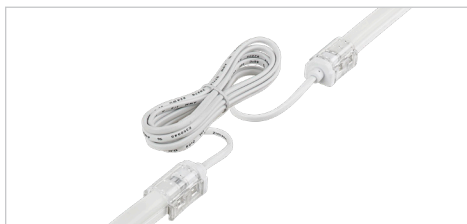

Linkable with DIY connectors - no soldering required!



79" (2 m) starter cords molded on each end for easy installation



Typical Setup:

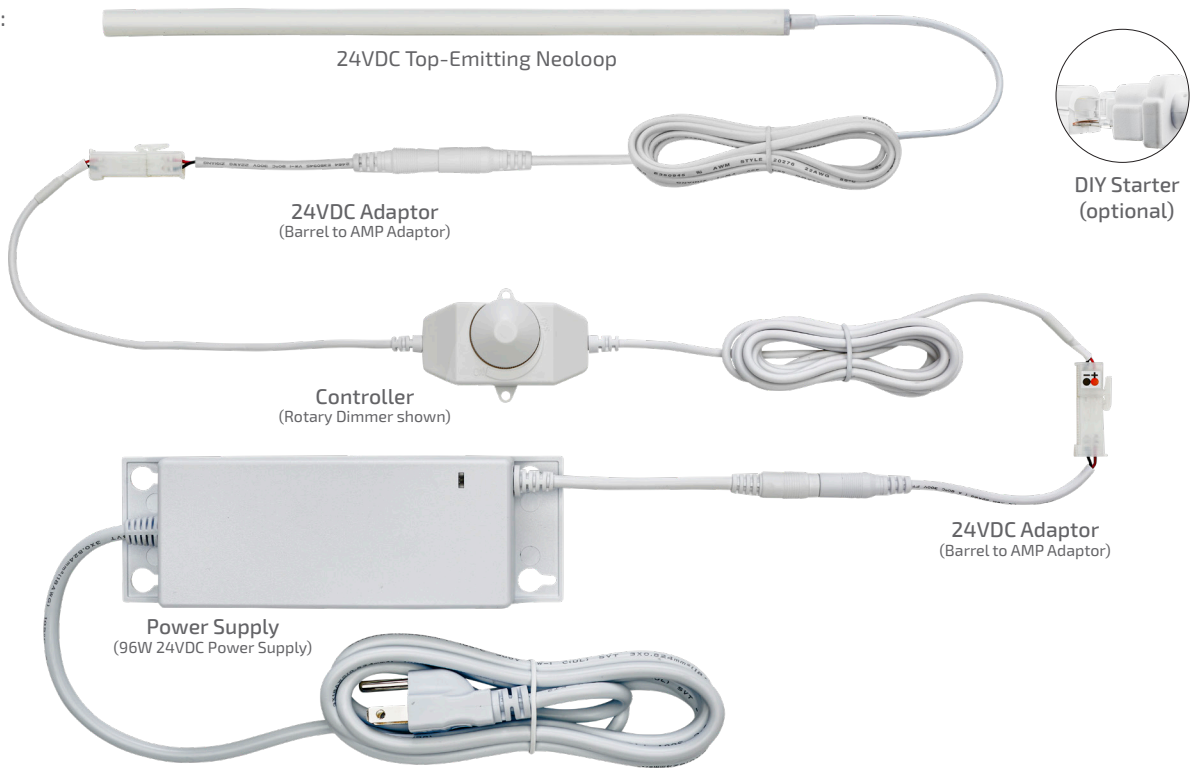

- Required
- Optional

Accessories:

<b>Power Supplies</b> See power supply section	<b>Controllers</b> See controller section	<b>Starter Cord Extensions</b> L-24BBEXT-1M-1 L-24BBEXT-2M-1 L-24BBEXT-3M-1	<b>U-Clips</b> L-N2-UCLP-1	<b>DIY Starter Cord</b> L-N2-24PKT-2M-1	<b>DIY Link Cords</b> L-N2-LNK25-1 L-N2-LNK60-1 L-N2-LNK120-1 L-N2-LNK180-1	<b>DIY Back-to-Back Connector</b> L-N2-BTB-1	<b>DIY End Cap</b> L-N2-ENDCAP-1

Specifications:

Wattage	Lumens	Efficacy (lm/W)	Input Voltage	Diode Life	CRI	Bend Diameter	Bend Axis	Max Per 96W Power Supply	Mounting	Warranty	Beam Angle																						
3W/ft (9.8W/m)	200 per ft. (656 per m)	66.7	24VDC	50,000 Hours	>90	4" (100 mm)	Vertical	26.25' (8 m)	Recess/Surface	5 Year																							
Photometric Data						Color Temperature																											
	Height	Light Output	Beam Area																														
	1ft (.3 m)	43.2Fc (465lx)	4.1ft L x 2.8ft W (1.2 m L x .85 m W)																														
	3ft (.9 m)	4.8Fc (51.6lx)	12.3ft L x 8.3ft W (3.7 m L x 2.5 m W)																														
6ft (1.8 m)	1.2Fc (12.9lx)	24.6ft L x 16.7ft W (7.5 m L x 5.1 m W)																															
				<table border="1"> <tr> <th>Warm White</th> <th colspan="2">Warm to Neutral</th> <th>Cool White</th> <th>Daylight</th> </tr> <tr> <td></td> <td></td> <td></td> <td></td> <td></td> </tr> <tr> <td>2700K</td> <td>3000K</td> <td>3500K</td> <td>4500K</td> <td>5500K</td> <td>6500K</td> </tr> <tr> <td>▲ Warm (2700K)</td> <td>▲ Warm (3000K)</td> <td>▲ Neutral (3500K)</td> <td>▲ Cool (4800K)</td> <td>▲ Daylight (6500K)</td> <td></td> </tr> </table>				Warm White	Warm to Neutral		Cool White	Daylight						2700K	3000K	3500K	4500K	5500K	6500K	▲ Warm (2700K)	▲ Warm (3000K)	▲ Neutral (3500K)	▲ Cool (4800K)	▲ Daylight (6500K)					
Warm White	Warm to Neutral		Cool White	Daylight																													
2700K	3000K	3500K	4500K	5500K	6500K																												
▲ Warm (2700K)	▲ Warm (3000K)	▲ Neutral (3500K)	▲ Cool (4800K)	▲ Daylight (6500K)																													
L-N2-24V3WM-48K-8M-1 Tested																																	

See page 96 for part numbers and descriptions

## ● 12VDC Side-Emitting Neoloop

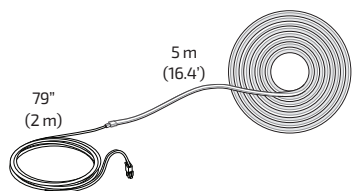

## ● 12VDC Top-Emitting Neoloop

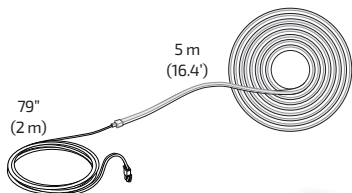

## ● 12VDC Power Supplies



## ● 12VDC DIY Neoloop Starter Cords

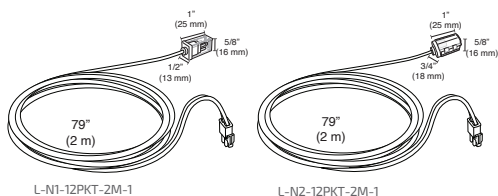

## ● 12VDC Starter Cord Extension Leads

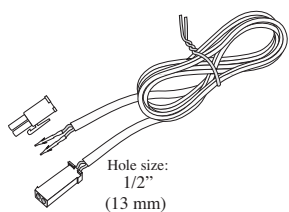

## ● 24VDC Side-Emitting Neoloop

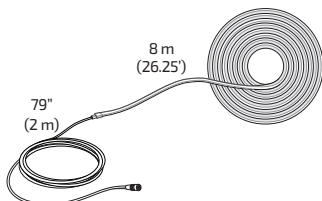

## ● 24VDC Top-Emitting Neoloop

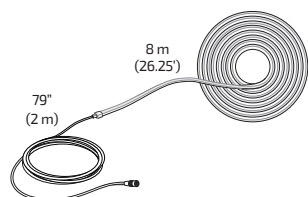

Part #	Description
L-N1-12V3WM-27K-5M-1	12VDC 3W/FT 5 m (16.4') 2700K N1 Side w/ 2 Molded Inputs
L-N1-12V3WM-30K-5M-1	12VDC 3W/FT 5 m (16.4') 3000K N1 Side w/ 2 Molded Inputs
L-N1-12V3WM-35K-5M-1	12VDC 3W/FT 5 m (16.4') 3500K N1 Side w/ 2 Molded Inputs
L-N1-12V3WM-48K-5M-1	12VDC 3W/FT 5 m (16.4') 4800K N1 Side w/ 2 Molded Inputs
L-N1-12V3WM-65K-5M-1	12VDC 3W/FT 5 m (16.4') 6500K N1 Side w/ 2 Molded Inputs

Part #	Description
L-N2-12V3WM-27K-5M-1	12VDC 3W/FT 5 m (16.4') 2700K N2 Top w/ 2 Molded Inputs
L-N2-12V3WM-30K-5M-1	12VDC 3W/FT 5 m (16.4') 3000K N2 Top w/ 2 Molded Inputs
L-N2-12V3WM-35K-5M-1	12VDC 3W/FT 5 m (16.4') 3500K N2 Top w/ 2 Molded Inputs
L-N2-12V3WM-48K-5M-1	12VDC 3W/FT 5 m (16.4') 4800K N2 Top w/ 2 Molded Inputs
L-N2-12V3WM-65K-5M-1	12VDC 3W/FT 5 m (16.4') 6500K N2 Top w/ 2 Molded Inputs

79" (2 m) starter cords molded on each end. Rout a 6 mm W x 12 mm D (Side-Emitting (N1)) or 10 mm W x 9.5 mm D (Top-Emitting (N2)) groove for a tight recessed installation or surface mount with U-Clips (sold separately).

For details see Power Supplies on Page 150.

Part #	Description
L-N1-12PKT-2M-1	12VDC 2 m (79") Neoloop DIY Starter Lead, Side-Emitting
L-N2-12PKT-2M-1	12VDC 2 m (79") Neoloop DIY Starter Lead, Top-Emitting

Part #	Description
L-LED-LINKD-8-1	8 cm (3") 12VDC Starter/Link/Extension Cord
L-LED-LINKD-15-1	15 cm (6") 12VDC Starter/Link/Extension Cord
L-LED-LINKD-25-1	25 cm (10") 12VDC Starter/Link/Extension Cord
L-LED-LINKD-60-1	60 cm (24") 12VDC Starter/Link/Extension Cord
L-LED-LINKD-120-1	120 cm (48") 12VDC Starter/Link/Extension Cord
L-LED-LINKD-180-1	180 cm (72") 12VDC Starter/Link/Extension Cord
L-LED-LINKD-245-1	245 cm (96") 12VDC Starter/Link/Extension Cord

Part #	Description
L-N1-24V3WM-27K-8M-1	24VDC 3W/FT 8 m (26.25') 2700K N1 Side w/ 2 Molded Inputs
L-N1-24V3WM-30K-8M-1	24VDC 3W/FT 8 m (26.25') 3000K N1 Side w/ 2 Molded Inputs
L-N1-24V3WM-35K-8M-1	24VDC 3W/FT 8 m (26.25') 3500K N1 Side w/ 2 Molded Inputs
L-N1-24V3WM-48K-8M-1	24VDC 3W/FT 8 m (26.25') 4800K N1 Side w/ 2 Molded Inputs
L-N1-24V3WM-65K-8M-1	24VDC 3W/FT 8 m (26.25') 6500K N1 Side w/ 2 Molded Inputs

Part #	Description
L-N2-24V3WM-27K-8M-1	24VDC 3W/FT 8 m (26.25') 2700K N2 Top w/ 2 Molded Inputs
L-N2-24V3WM-30K-8M-1	24VDC 3W/FT 8 m (26.25') 3000K N2 Top w/ 2 Molded Inputs
L-N2-24V3WM-35K-8M-1	24VDC 3W/FT 8 m (26.25') 3500K N2 Top w/ 2 Molded Inputs
L-N2-24V3WM-48K-8M-1	24VDC 3W/FT 8 m (26.25') 4800K N2 Top w/ 2 Molded Inputs
L-N2-24V3WM-65K-8M-1	24VDC 3W/FT 8 m (26.25') 6500K N2 Top w/ 2 Molded Inputs

79" (2 m) starter cords molded on each end. Rout a 6 mm W x 12 mm D (Side-Emitting (N1)) or 10 mm W x 9.5 mm D (Top-Emitting (N2)) groove for a tight recessed installation or surface mount with U-Clips (sold separately).

● 24VDC Power Supplies



For details see Power Supplies on Page 150.

● 24VDC DIY Neoloop Starter Cords

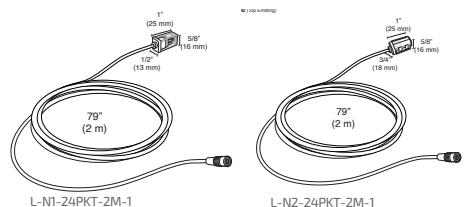

Part #	Description
L-N1-24PKT-2M-1	24VDC 2 m (79") Neoloop DIY Starter Lead, Side-Emitting
L-N2-24PKT-2M-1	24VDC 2 m (79") Neoloop DIY Starter Lead, Top-Emitting

● 24VDC Starter Cord Extension Leads

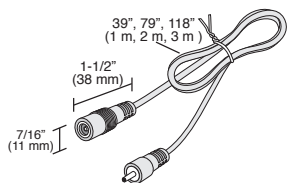

Part #	Description
L-24BBEXT-1M-1	1 m (39") 24VDC ML/FML Barrel Extension, White
L-24BBEXT-2M-1	2 m (79") 24VDC ML/FML Barrel Extension, White
L-24BBEXT-3M-1	3 m (119") 24VDC ML/FML Barrel Extension, White

● 12/24VDC DIY Neoloop Link Cords

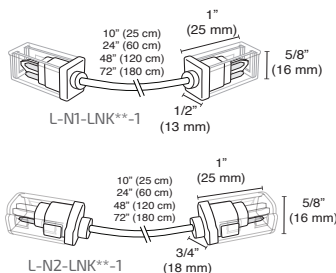

Part #	Description
L-N1-LNK25-1	12/24VDC 25 cm (10") Neoloop DIY Link Cord, Side-Emitting
L-N1-LNK60-1	12/24VDC 60 cm (24") Neoloop DIY Link Cord, Side-Emitting
L-N1-LNK120-1	12/24VDC 120 cm (48") Neoloop DIY Link Cord, Side-Emitting
L-N1-LNK180-1	12/24VDC 180 cm (72") Neoloop DIY Link Cord, Side-Emitting
L-N2-LNK25-1	12/24VDC 25 cm (10") Neoloop DIY Link Cord, Top-Emitting
L-N2-LNK60-1	12/24VDC 60 cm (24") Neoloop DIY Link Cord, Top-Emitting
L-N2-LNK120-1	12/24VDC 120 cm (48") Neoloop DIY Link Cord, Top-Emitting
L-N2-LNK180-1	12/24VDC 180 cm (72") Neoloop DIY Link Cord, Top-Emitting

● 12/24VDC DIY Neoloop Back-to-Back Connector

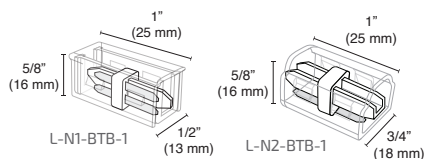

Part #	Description
L-N1-BTB-1	12/24VDC Neoloop DIY Back-to-Back Connector, Side-Emitting
L-N2-BTB-1	12/24VDC Neoloop DIY Back-to-Back Connector, Top-Emitting

● 12/24VDC DIY Neoloop End Caps

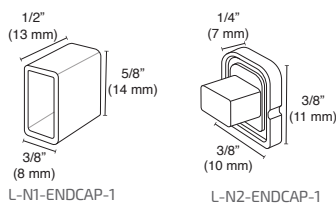

Part #	Description
L-N1-ENDCAP-1	12/24VDC Neoloop DIY End Cap, Side-Emitting
L-N2-ENDCAP-1	12/24VDC Neoloop DIY End Cap, Top-Emitting

● 12/24VDC Neoloop U-Clips

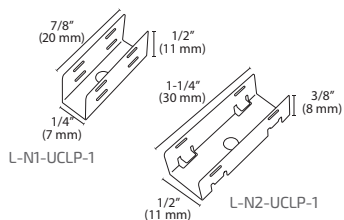

Part #	Description
L-N1-UCLP-1	12/24VDC Neoloop DIY U-Clip Mount, Side-Emitting (10 pcs)
L-N2-UCLP-1	12/24VDC Neoloop DIY U-Clip Mount, Top-Emitting (10 pcs)





STITCH

FRAGRANCES





12VDC

24VDC

PANEL





12VDC

Etch panels provide the perfect solution for commercial and residential backlighting and shelf lighting applications with high light output, uniform intensity and minimal separation between the LED panel and the illuminated material. Order it fully constructed or pre-etched panels only.

US PATENT NO: 10,113,708 and 10,473,305



Features:

Fully customized, assembled, and ready to plug-in

12VDC - 5W/ft.

Available in (5) color temperatures: 3000K, 3500K, 4000K, 5500K, and 6500K

Short lead times (4-7 days typical)\*

Premium acrylic for optical clarity

Optimized Etch pattern for even illumination

\*High volume orders will begin shipping within 7 days but may not ship in full

Typical Applications:

Displays

Exhibits

Signage

Store Fixtures

Countertops

Backsplashes

Modesty Panels

Shelving

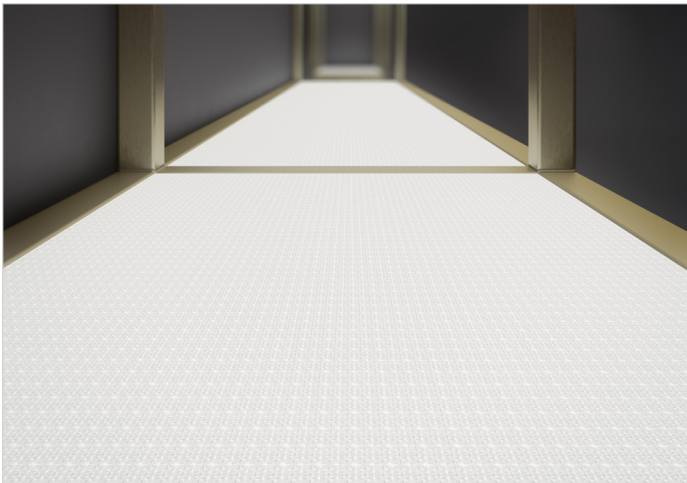

Unique patented edge-lighting and LED process provides high output with even illumination



Listed in SAM Manual



Made in the USA at Tresco's manufacturing facility in Louisville, KY



Requires zero separation between the light panel and the backlit surface

Dimensions:

Acrylic Only

Fully Assembled with backer

5/16" (8 mm)

3/8" (9.8 mm)

1/16" (1.5 mm)

11/32" (8.8 mm)

Thicknesses are subject to the industry standard of +/-10 % for acrylic

**Typical Setup:**  
(Standard wire exit shown)

Etch

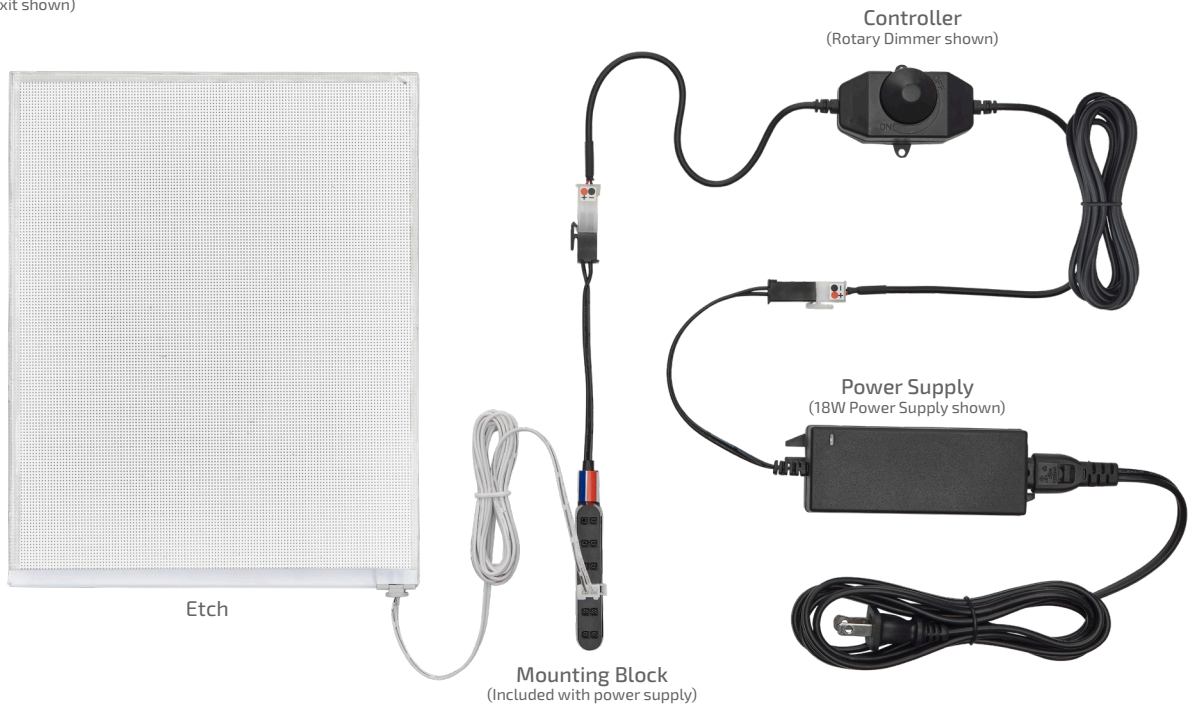

- Required
- Optional



**Power Supplies**  
see power supply section

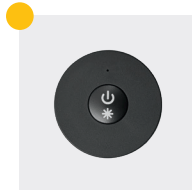

**Controllers**  
see controller section



Scan or visit:  
[www.trescolighting.com/etch-form](http://www.trescolighting.com/etch-form) for a custom quote (trade only).

**Specifications:**

Wattage	Lumens	Input Voltage	Diode Life	Mounting	Minimum Size	Maximum Size	Environment	Warranty
5W/ft. (16.4W/m) Per LED populated edge of panel	100 per watt	12VDC	50,000 Hours	Surface	4" x 4" (102 mm x 102 mm)	48" x 96" (1219 mm x 2438 mm)	Dry and damp locations only	3 Year

**Color Temperature**

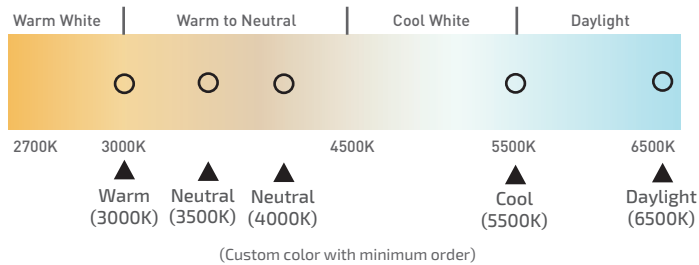

# Etch

## Specifications by Size

Size	LED Strip	Wattage	Wire Exits
6" x 6" (152 mm x 152 mm)	1 Edge	2.5W	1
12" x 12" (305 mm x 305 mm)	1 Edge	5W	1
24" x 24" (610 mm x 610 mm)	2 or 4 Edges	20W/40W	1
36" x 36" (915 mm x 915 mm)	2 or 4 Edges	30W/60W	2
48" x 48" (1219 mm x 1219 mm)	2 or 4 Edges	40W/80W	2
48" x 96" (1219 mm x 2438 mm)	2 Edges	60W	2

### How to Select Number of LED Edges

#### One Edge



Panel width up to 15" (381 mm)

#### Two Edges

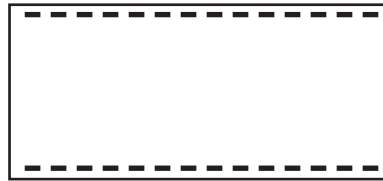

Panel width over 15" (381 mm)

#### All Edges

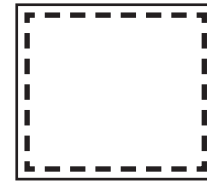

Typically used for perfect squares and larger sizes.

### Typical Surface Brightness Measure

Only 10% drop in surface illuminance from edge of panel to center (based on largest panel size).

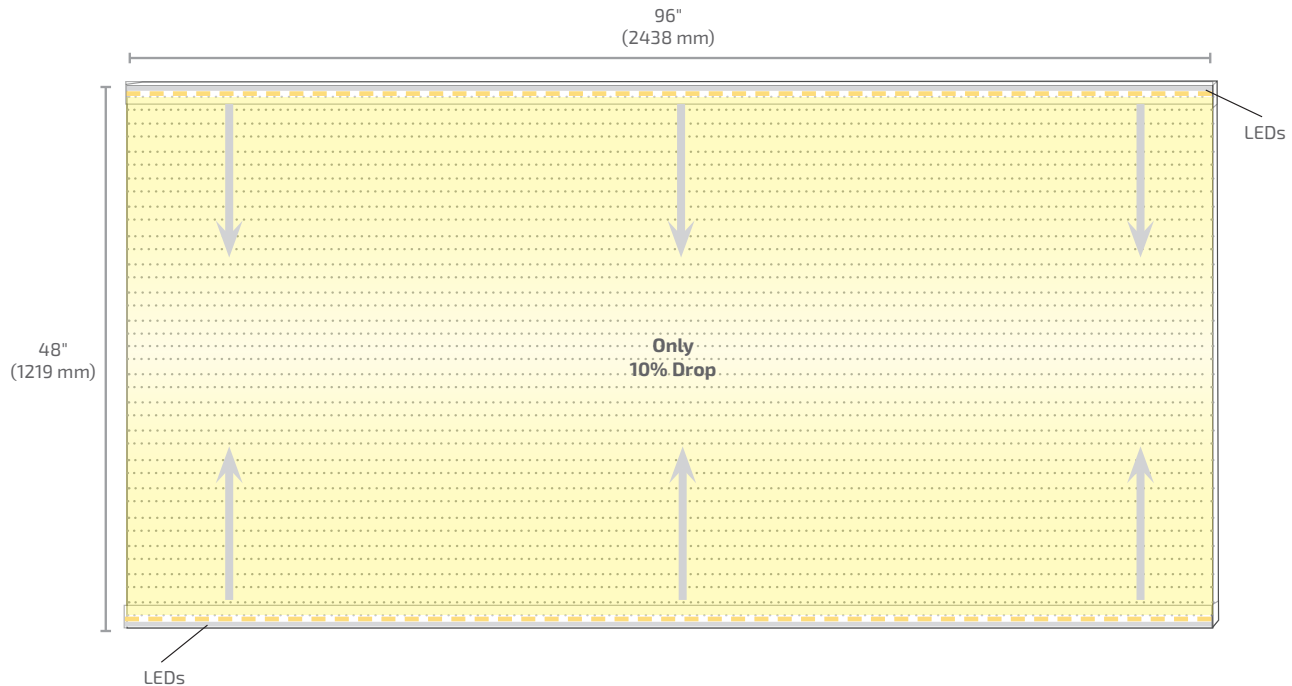



1 or 2 Sided Illumination

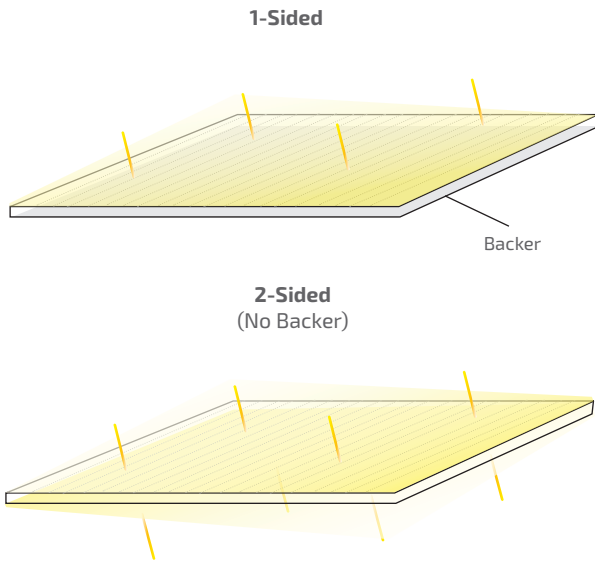

Minimize Seams When Tiling

Minimum distance to minimize seams between material and Etch panels.

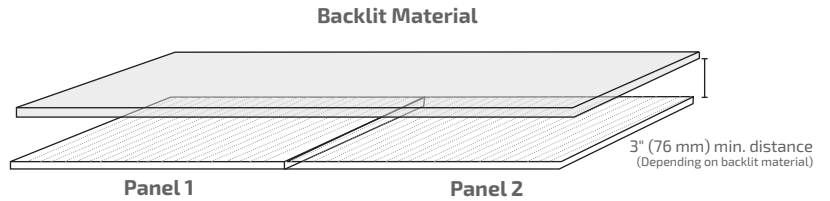

Cord Exit Options

79" (2 m) Starter cord location is customizable

LEDs will be placed on long edges unless specified as short edge on the RFQ form.

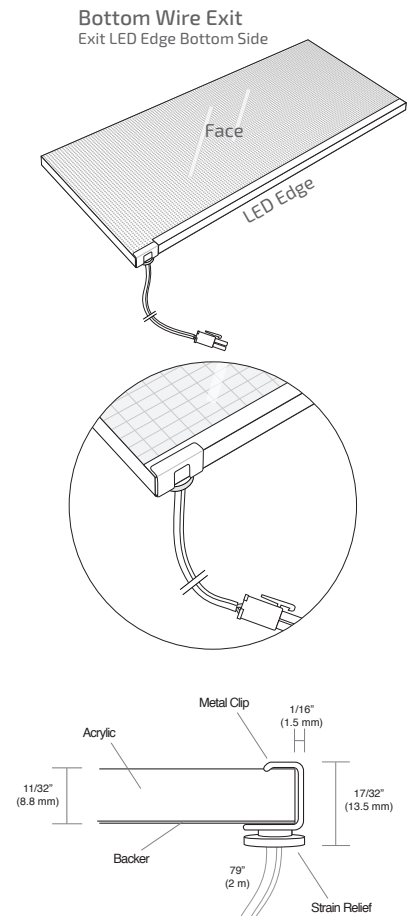
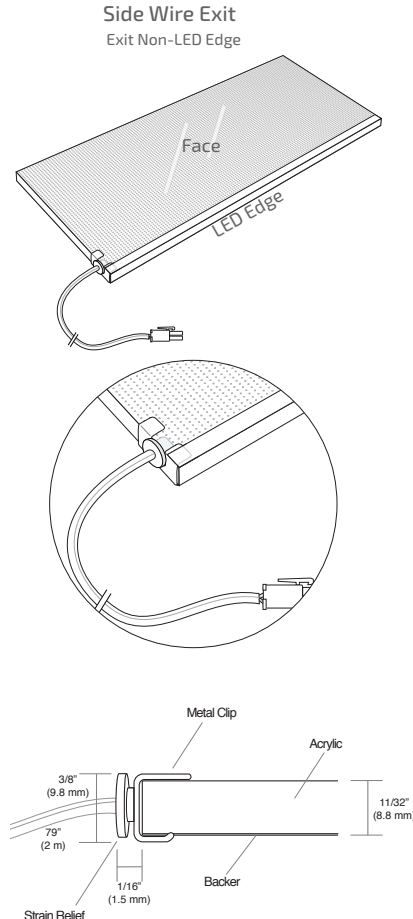
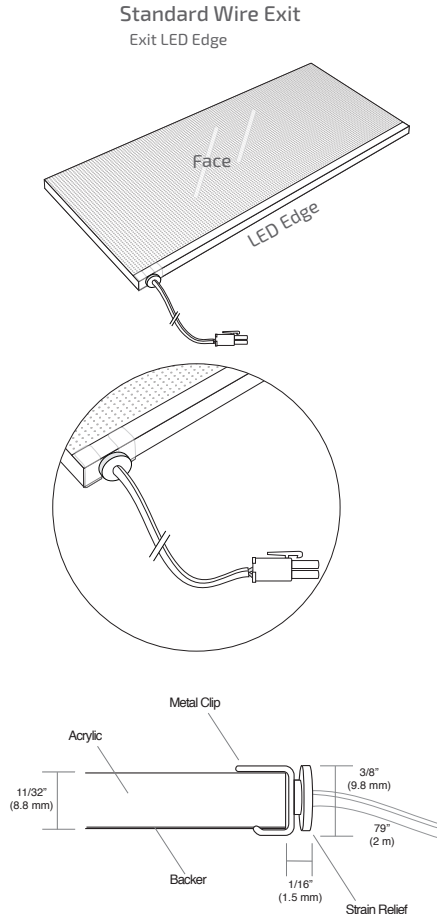

# Etch

## Cosmetic Tape Color

The cosmetic tape hides the LEDs and reflects light back into the panel. Cosmetic tape overlaps the face of the panel only along the LED edge. On all edges without LEDs, the cosmetic tape only runs along the edge of the panel.

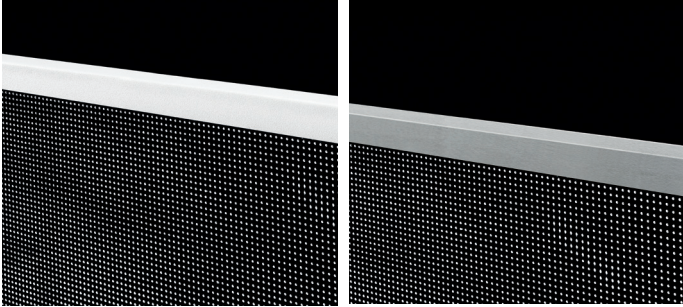

White

Silver

Flush with side

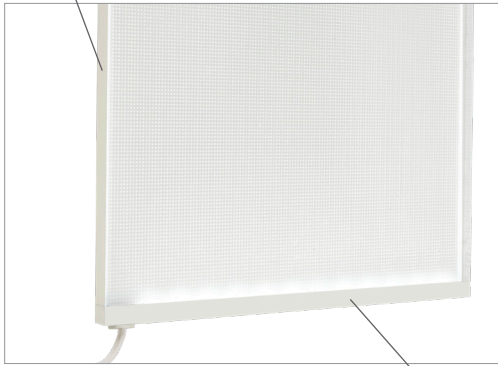

Covers LEDs on LED edge

## Mounting Options

### Secure panel with screws

#### Drilling Instructions\*:

- Drill pilot holes before securing with screws
- Use the highest grit bit as possible
- Drill on flat supportive surface
- **Don't drill within 1/4" (7 mm) of edge of panel**

\*Tresco Lighting is not responsible for any splintering or any other errors that may occur with drilling a panel on site.

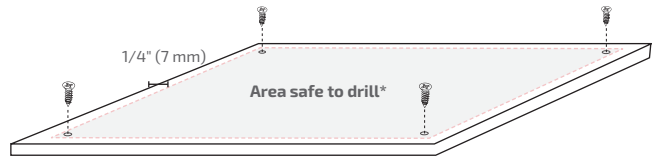

### Mounting Clips

Optional mounting clips available.

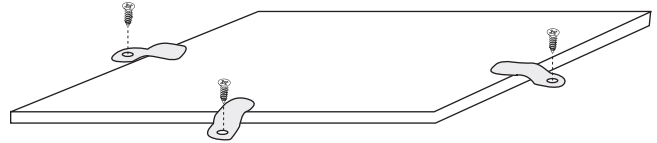

## Diffusers

A diffuser is an optional addition for one illuminated side of the panel to help diffuse the light.

Rigid White/Milk up to 96" x 48"  
(2438 mm x 1219 mm)

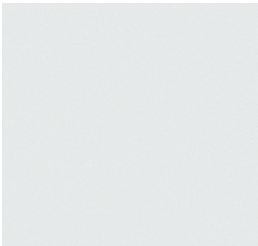

RIGID WHITE/MILK







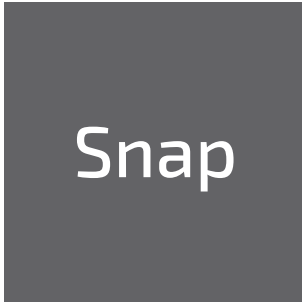

24VDC

Standard:  
8W/ft<sup>2</sup>  
High:  
15W/ft<sup>2</sup>

Standard:  
900 Lumens  
High:  
1670 Lumens



Customized lighting solutions are just a "snap" away with the Snap Panels. Sold in 12" x 12" (305 mm x 305 mm) squares, the razor-thin panels can be snapped down to 3" x 3" (76 mm x 76 mm) squares and connected back into any configuration, creating the perfect solution with complete light uniformity.

Features:

Offered in 15W/ft<sup>2</sup> (high) and 8W/ft<sup>2</sup> (standard)

24VDC System

Available in (4) color temperatures: 3000K, 4000K, 5000K and 6500K

Just 1.65 mm thick and extremely lightweight

Modular DIY system

Typical Applications:

Displays

Exhibits

Signage

Store Fixtures

Uplighting Countertops

Backsplashes (Backlighting)

Modesty Panels

Cabinets

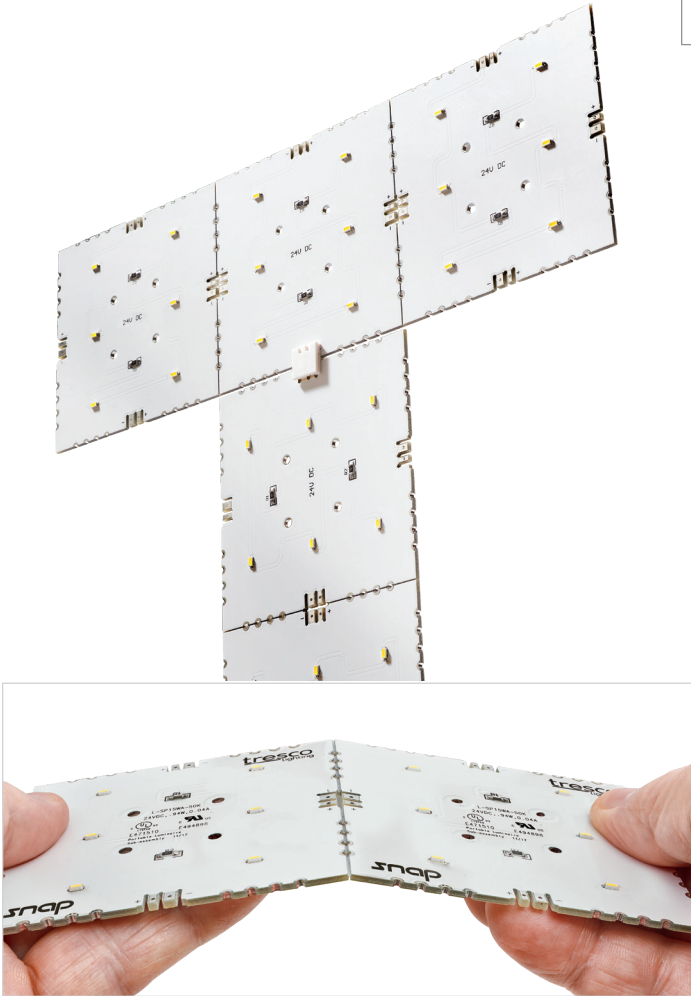

Sold as 12" x 12" (305 mm x 305 mm) panels with (16) 3" x 3" (76 mm x 76 mm) snappable squares on each panel



Great for backlighting translucent countertops



Dimensions:

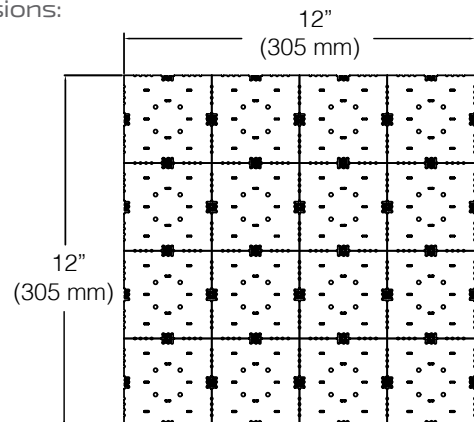



Typical Setup:



Snap

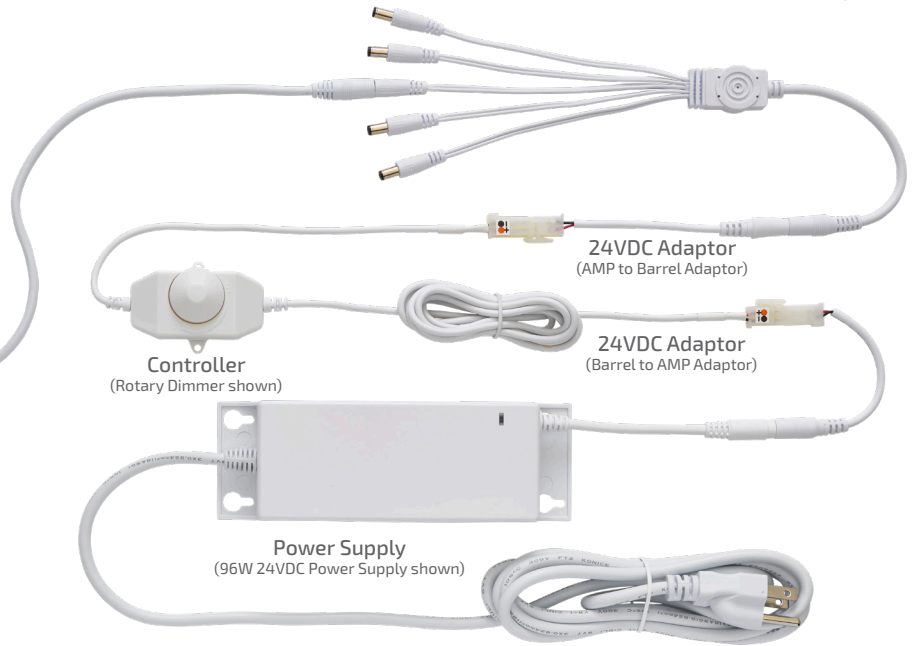

- Required
- Optional

Accessories:



- 24VDC Power Supplies**  
see power supply section
- Starter Cord**  
L-SPPKT-305MM-1  
L-SPPKT-1M-1  
L-SPPKT-3M-1
- Controllers**  
see controller section
- Snap Link Cord**  
L-SPLNK8-1  
L-SPLNK25-1  
L-SPLNK60-1  
L-SPLNK120-1
- Connectors**  
L-SPBTB10-1  
L-SP90BTB4-1
- Curtain Connectors**  
L-SP3TCS-1  
L-SP6TCS-1
- Starter Cord Extensions**  
L-24BBEXT-1M-1  
L-24BBEXT-2M-1  
L-24BBEXT-3M-1
- Acrylic Stand-offs**  
L-SPSTND1-1  
L-SPSTND2-1

Specifications:

	Wattage	Lumens	Efficacy (lm/W)	Input Voltage	Diode Life	Max Per 96W Power Supply	Mounting	Warranty	Beam Angle
High Standard	8W/ft <sup>2</sup> (.5W per 3" square)	900	112	24VDC	50,000 Hours	12ft <sup>2</sup>	Surface	5 Year	
	15w/ft <sup>2</sup> (.94W per 3" square)	1670	111			6.4ft <sup>2</sup>			
Photometric Data					Color Temperature				
	Height	Standard	High						
	2 in (5 cm)	10,202Fc (109,813lx)	18,995Fc (204,460lx)						
	4 in (10 cm)	2,708Fc (29,148lx)	5,401Fc (54,260lx)						
	6 in (15 cm)	1179Fc (12,690lx)	2,196Fc (23,637lx)						
	1 ft (.3 m)	295Fc (3,175lx)	549Fc (5,909lx)						
	3 ft (.9 m)	33Fc (353lx)	61Fc (656lx)						
6 ft (1.8 m)	8Fc (88lx)	15Fc (163lx)							
L-SP8WA-50K-1 (Standard) , L-SP15WA-50K-1 (High) Tested									

See page 112 for part numbers and descriptions

# Snap

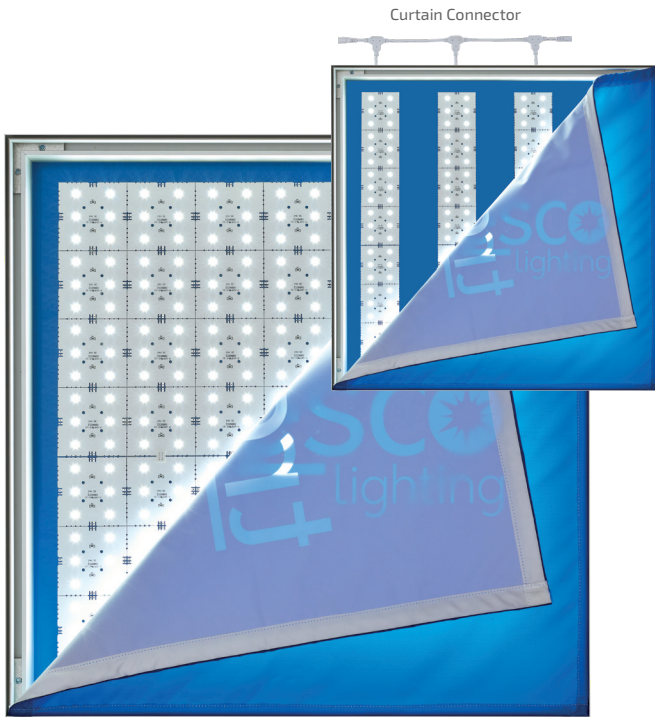

Just 2" (51 mm) of separation on average required between Snap and backlit surfaces. (8W or 15W)

OR Just 4" (102 mm) of separation required between Snap and backlit surfaces when strips are spaced 3" (76 mm) apart. (15W only)

Curtain connectors can be used to create rows (L-SP3TCS-1 and L-SP6TCS-1).

## Mounting

Adhesive mount clips and screws are included with each panel for mounting purposes.

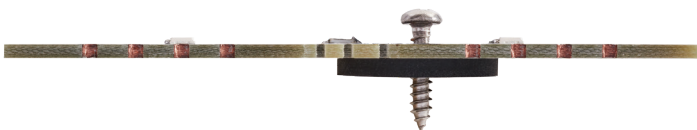

# Linking

Panel squares are tileable using our simple DIY connectors (no soldering necessary)



90-Degree Back-to-Back Link

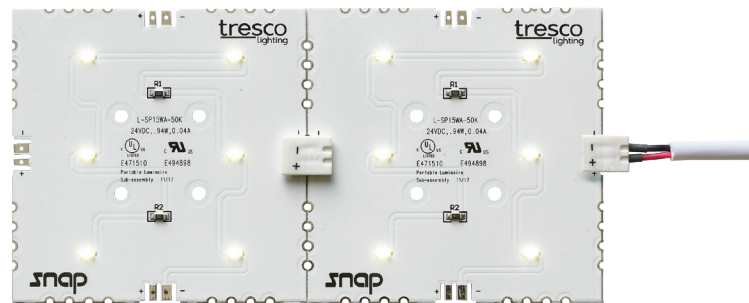

Back to Back Link  
L-SPBTB10-1

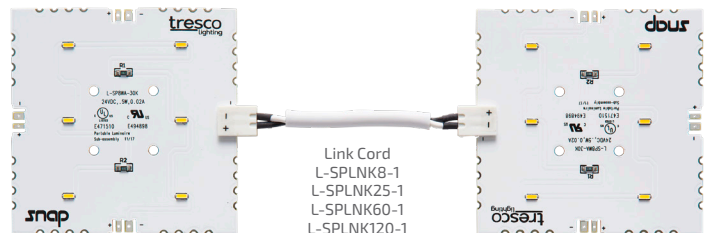

Link Cord  
L-SPLNK8-1  
L-SPLNK25-1  
L-SPLNK60-1  
L-SPLNK120-1



Applications



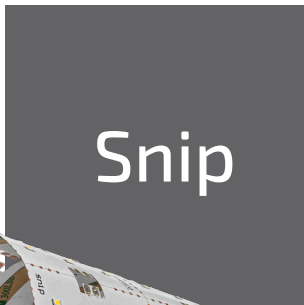

24VDC

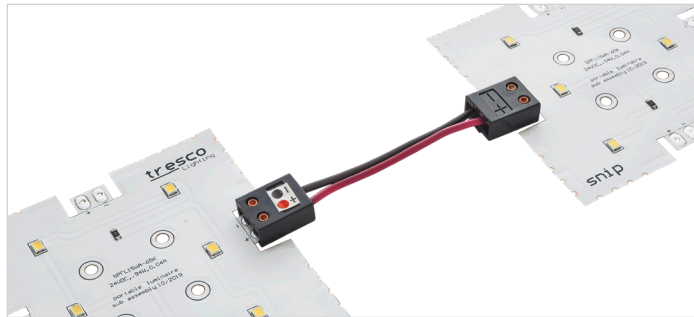

No soldering required - simple FlexConnect connectors (sold separately)



Cuttable and linkable modular DIY lighting system

<p>Standard: Full Sheet: 12W <b>8W/ft<sup>2</sup></b></p> <p>High: Full Sheet: 22.5W <b>15W/ft<sup>2</sup></b></p>	<p>Standard: Full Sheet: 1148 Lumens <b>765 lm/ft<sup>2</sup></b></p> <p>High: Full Sheet: 2067 Lumens <b>1378 lm/ft<sup>2</sup></b></p>	
<p>Paper-thin illumination, Snip panels have the flexibility to conform to curved surfaces and wrap around objects for continuous even illumination. Sold in 24" x 9" (610 mm x 229 mm) panels, the extremely lightweight LED sheets can be snipped into 3" x 3" (76 mm x 76 mm) squares and re-connected into any custom configuration; a versatile lighting solution for unique applications.</p>		

Features:

- Offered in 15W/ft<sup>2</sup> (high) and 8W/ft<sup>2</sup> (standard)
- Sold as a 24" x 9" (610 mm x 229 mm) flexible LED panel
- Available in (4) color temperatures: 3000K, 4000K, 5000K and 6500K
- Paper-thin with the flexibility to curve and wrap around objects or surfaces
- Cuttable and linkable modular 24VDC DIY lighting system
- No soldering required – simple FlexConnect connectors
- Strong 300 LSE 3M™ adhesive backing

Typical Applications:

- Displays
- Exhibits
- Signage
- Store Fixtures
- Backlighting



Dimensions:

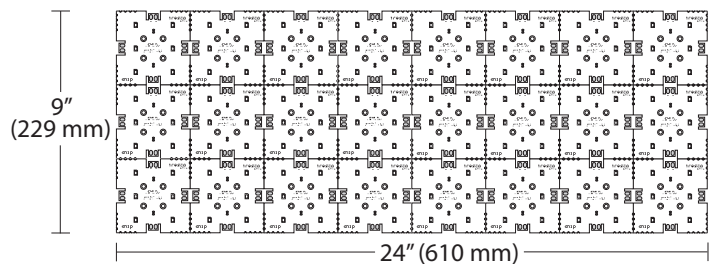



Typical Setup:

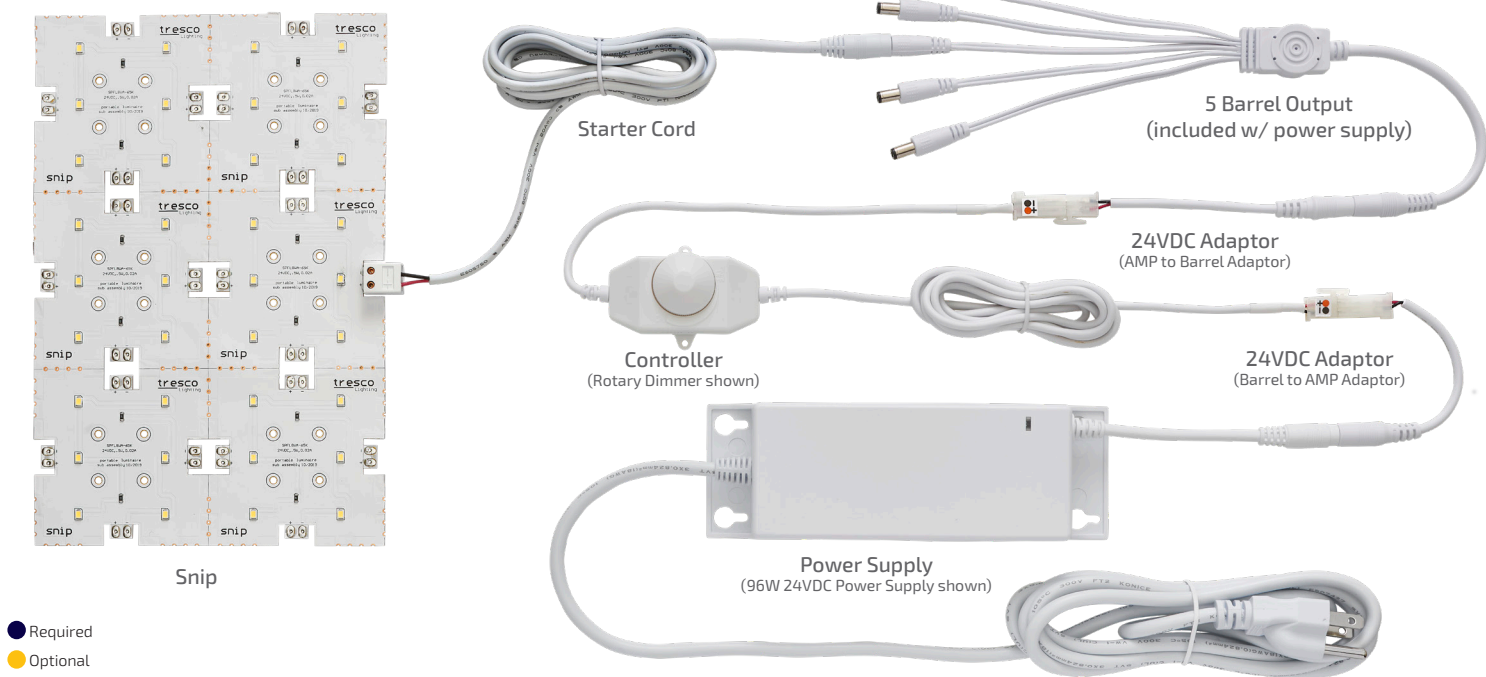

- Required
- Optional

Accessories:

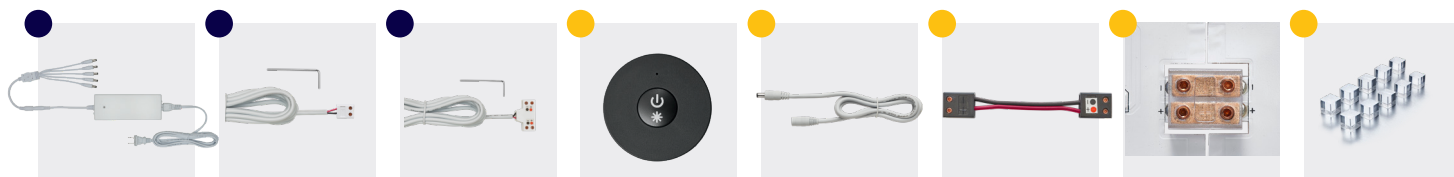

- 24VDC Power Supplies**  
see power supply section
- Starter Cord**  
L-24B2SPKT-305MM-1  
L-24B2SPKT-2M-1  
L-24B2SPKT-3M-1
- Tee Starter Cord**  
L-24B2SPKT-2M-TEE-1
- Controllers**  
see controller section
- Starter Cord Extensions**  
L-24BBEXT-1M-1  
L-24BBEXT-2M-1  
L-24BBEXT-3M-1
- Link Cords**  
L-LED-TPELNK-5-1  
L-LED-TPELNK-15-1  
L-LED-TPELNK-25-1  
L-LED-TPELNK-60-1  
L-LED-TPELNK-120-1  
L-LED-TPELNK-180-1
- Back-to Back Connector**  
L-XSBTB-1
- Acrylic Stand-offs**  
L-SPSTND1-1  
L-SPSTND2-1

Specifications:

	Wattage	Lumens	Efficacy (lm/W)	Input Voltage	Diode Life	CRI	Max Per 96W Power Supply	Mounting	Warranty	Beam Angle																	
High Standard	Full Sheet: 12W 8W/ft <sup>2</sup> (.5W per 3" square)	Full Sheet: 1148 765/ft <sup>2</sup>	95.7	24VDC	50,000 Hours	>93	12ft <sup>2</sup>	Surface	5 Year																		
	Full Sheet: 22.5W 15W/ft <sup>2</sup> (.94W per 3" square)	Full Sheet: 2067 1378/ft <sup>2</sup>	91.9			>93	6.4ft <sup>2</sup>																				
Photometric Data					Color Temperature																						
	Height	Light Output Standard/High	Beam Area	<table border="1"> <tr> <td>Warm White</td> <td>Warm to Neutral</td> <td>Cool White</td> <td>Daylight</td> </tr> <tr> <td></td> <td></td> <td></td> <td></td> </tr> <tr> <td>2700K</td> <td>3000K</td> <td>4500K</td> <td>5500K</td> <td>6500K</td> </tr> <tr> <td>Warm (3000K)</td> <td>Neutral (4000K)</td> <td>Cool (5000K)</td> <td>Daylight (6500K)</td> </tr> </table>							Warm White	Warm to Neutral	Cool White	Daylight					2700K	3000K	4500K	5500K	6500K	Warm (3000K)	Neutral (4000K)	Cool (5000K)	Daylight (6500K)
	Warm White	Warm to Neutral	Cool White	Daylight																							
	2700K	3000K	4500K	5500K	6500K																						
Warm (3000K)	Neutral (4000K)	Cool (5000K)	Daylight (6500K)																								
1ft (.3 m)	381Fc / 686Fc (4102lx) / (7384lx)	3.3ft L x 3.2ft W (1 m L x .91 m W)																									
3ft (.9 m)	42.3Fc / 76.2Fc (455.3lx) / (820.2lx)	10ft L x 9.6ft W (3 m L x 3 m W)																									
6ft (1.8 m)	10.6Fc / 19.1Fc (114.1lx) / (205.6lx)	20ft L x 19.2ft W (6.2 m L x 6 m W)																									
L-SPFL8WA-50K-1 / L-SPFL15WA-50K-1 Tested																											

See page 113 for part numbers and descriptions

- Required
- Optional

## 24VDC Light Panel

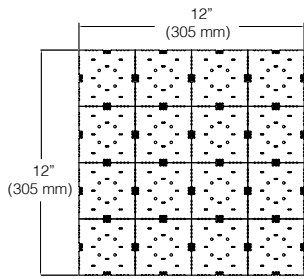

Part #	Description
L-SP8WA-30K-1	24VDC 8W 12" (305 mm) Square Snap Panel 3000K
L-SP8WA-40K-1	24VDC 8W 12" (305 mm) Square Snap Panel 4000K
L-SP8WA-50K-1	24VDC 8W 12" (305 mm) Square Snap Panel 5000K
L-SP8WA-65K-1	24VDC 8W 12" (305 mm) Square Snap Panel 6500K
L-SP15WA-30K-1	24VDC 15W 12" (305 mm) Square Snap Panel 3000K
L-SP15WA-40K-1	24VDC 15W 12" (305 mm) Square Snap Panel 4000K
L-SP15WA-50K-1	24VDC 15W 12" (305 mm) Square Snap Panel 5000K
L-SP15WA-65K-1	24VDC 15W 12" (305 mm) Square Snap Panel 6500K

Mounting clips and screws included. Starter cords sold separately.

## 24VDC Starter Cord

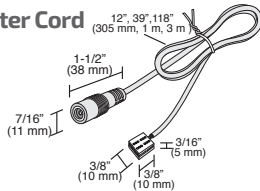

Part #	Description
L-SPPKT-305MM-1	305 mm (12") Snap Panel Starter Lead
L-SPPKT-1M-1	1 m (39") Snap Panel Starter Lead
L-SPPKT-3M-1	3 m (118") Snap Panel Starter Lead

## 24VDC Power Supplies

For details see Power Supplies on Page 150.

Part #	Description
L-24DCELT96-1	96W 24VDC Power Supply w/ 5 Barrel Out - White†
L-24DCELT48-BL-1	48W 24VDC Power Supply w/ 5 Barrel Out - Black†
L-24DCELT15WP-1	15W 24VDC Wall Mount Power Supply w/ Snap Connector*†
L-24DCH96X1-1	96W 24VDC Dimmable Hardwire Power Supply*§
L-24DCH96X3-1	288W 24VDC Dimmable Hardwire Power Supply*§
L-24DCH96X4-120-277V-1	384W 24VDC Commercial Hardwire 0-10V Dimmable Power Supply
L-1BRL5-1	Extra 5 Output Barrel Splice

\*Does not come with 5 Output Barrel Splice

†Dimmable on trailing edge (24VDC side)

§Dimmable by LED line voltage (120V) wall dimmers

## Snap Connectors

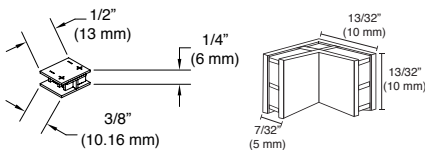

Part #	Description
L-SPBTB10-1	Snap Panel Back-to-Back Links (10 pcs)
L-SP90BTB4-1	Snap Panel 90° Back-to-Back Link (4 pcs)
Part #	Description
L-SPSTND1-1	1" Stand Off - 10/PK
L-SPSTND2-1	2" Stand Off - 10/PK

## Snap Link Cord

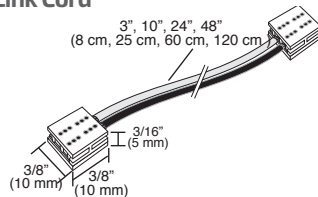

Part #	Description
L-SPLNK8-1	3" (8 cm) Snap Panel Link Cord
L-SPLNK25-1	10" (25 cm) Snap Panel Link Cord
L-SPLNK60-1	24" (60 cm) Snap Panel Link Cord
L-SPLNK120-1	48" (120 cm) Snap Panel Link Cord

## 24VDC Curtain Connectors

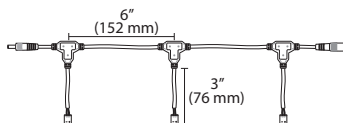

Part #	Description
L-SP3TCS-1	Three Way Curtain Starter Lead
L-SP6TCS-1	Six Way Curtain Starter Lead

## 24VDC Extension Leads

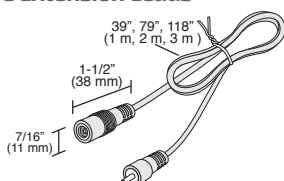

Part #	Description
L-24BBEXT-1M-1	1 m (39") 24VDC ML/FML Barrel Extension, White
L-24BBEXT-2M-1	2 m (79") 24VDC ML/FML Barrel Extension, White
L-24BBEXT-3M-1	3 m (119") 24VDC ML/FML Barrel Extension, White

## ● 24VDC Light Panel

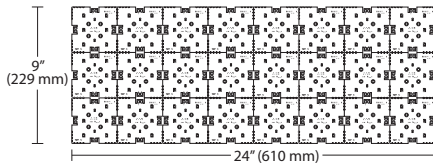

Part #	Description
L-SPFL8WA-30K-1	24VDC 8W/SQFT 1.5SQFT 3000K Snip Panel
L-SPFL8WA-40K-1	24VDC 8W/SQFT 1.5SQFT 4000K Snip Panel
L-SPFL8WA-50K-1	24VDC 8W/SQFT 1.5SQFT 5000K Snip Panel
L-SPFL8WA-65K-1	24VDC 8W/SQFT 1.5SQFT 6500K Snip Panel
L-SPFL15WA-30K-1	24VDC 15W/SQFT 1.5SQFT 3000K Snip Panel
L-SPFL15WA-40K-1	24VDC 15W/SQFT 1.5SQFT 4000K Snip Panel
L-SPFL15WA-50K-1	24VDC 15W/SQFT 1.5SQFT 5000K Snip Panel
L-SPFL15WA-65K-1	24VDC 15W/SQFT 1.5SQFT 6500K Snip Panel

## ● 24VDC Starter Cord

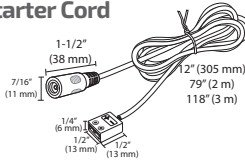

Part #	Description
L-24B2SPKT-305MM-1	24VDC 305 mm (12") Barrel/2 Screw Trml Starter Lead, White
L-24B2SPKT-2M-1	24VDC 2 m (79") Barrel/2 Screw Trml Starter Lead, White
L-24B2SPKT-3M-1	24VDC 3 m (118") Barrel/2 Screw Trml Starter Lead, White

## ● 24VDC Tee Starter Cord

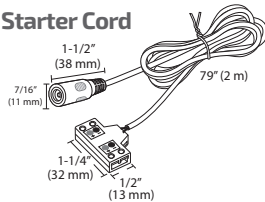

Part #	Description
L-24B2SPKT-2M-TEE-1	24VDC 2 m (79") Barrel/2 Screw Trml Tee Starter Lead, White

Part #	Description
L-SPSTND1-1	1" Stand Off - 10/PK
L-SPSTND2-1	2" Stand Off - 10/PK

## ● 24VDC Power Supplies

For details see  
Power Supplies on  
Page 150.

Part #	Description
L-24DCELT96-1	24VDC 96W Power Supply w/ 5 Barrel Out, White†
L-24DCELT48-BL-1	24VDC 48W Power Supply w/ 5 Barrel Out, Black†
L-24DCELT15WP-1	24VDC 15W Wall Mount Power Supply w/ Snap Connector*†
L-24DCH96X1-1	24VDC 96W Dimmable Hardwire Power Supply*§
L-24DCH96X3-1	24VDC 288W Dimmable Hardwire Power Supply*§
L-24DCH96X4-120-277V-1	384W 24VDC Commercial Hardwire 0-10V Dimmable Power Supply
L-1BRL5-1	Extra 5 Output Barrel Splice, White

\*Does not come with 5 Output Barrel Splice

†Dimmable on trailing edge (24VDC side)

§Dimmable by LED line voltage (120V) wall dimmers

## ● 24VDC Extension Leads

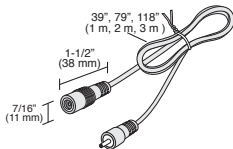

Part #	Description
L-24BBEXT-1M-1	24VDC 1 m (39") ML/FML Barrel Extension, White
L-24BBEXT-2M-1	24VDC 2 m (79") ML/FML Barrel Extension, White
L-24BBEXT-3M-1	24VDC 3 m (118") ML/FML Barrel Extension, White

## ● 12/24VDC Link Cord

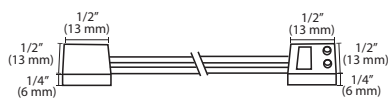

Positive and negative contacts on FlexTape® and FlexConnects should match-up to maintain proper polarity.

Part #	Description
L-LED-TPELNK-5-1	12/24VDC 5 cm (2") FlexTape® Link Cord
L-LED-TPELNK-15-1	12/24VDC 15 cm (6") FlexTape® Link Cord
L-LED-TPELNK-25-1	12/24VDC 25 cm (10") FlexTape® Link Cord
L-LED-TPELNK-60-1	12/24VDC 60 cm (24") FlexTape® Link Cord
L-LED-TPELNK-120-1	12/24VDC 120 cm (48") FlexTape® Link Cord
L-LED-TPELNK-180-1	12/24VDC 180 cm (72") FlexTape® Link Cord

Link cords are used for both Snip and single color FlexTape®

## ● 12/24VDC Back-to-Back Connector

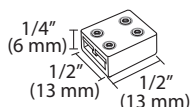

Part #	Description
L-XSBTB-1	12/24VDC 10 mm, 2 Position Back-to-Back Connector, Clear







12VDC  
24VDC

WHITE TUNABLE



12VDC

# White Tunable FlexTape®

3W/ft.  
(9.8W/m)

345 Lumens  
per ft.  
(1132 per meter)



Changing your light source's color temperature is easy with Tresco® White Tunable (CCT) FlexTape® lighting solution. Select between warmer lighting that highlights natural wood grains and earth tones or cool lighting to highlight whites; perfect for cabinet, task or accent lighting and store fixtures. The low profile and adhesive 3M™ backing give this LED lighting solution the versatility to install in a multitude of places. Eliminate the guesswork and get the LED that pairs perfectly with your general lighting and overall design.

### Features:

115° beam angle

High output (345 lumens per ft.)

White tunable from 2700K-6500K

Sold in 16.4' (5 m) roll

Cuttable every 1" (25 mm)

No soldering required – simple FlexConnect connectors (sold separately)

Precision tunable remote controls (sold separately)

### Typical Applications:

Under Cabinet

Interior Cabinets

Accent Lighting

Displays

Task Lighting

Store fixtures

Toe kick

Soffit

Backlighting



### Dimensions:

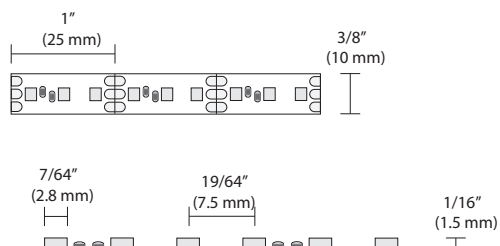

White Tunable FlexTape® can be used as a DIY option for flush and recessed Infinex. For other profiles, must be custom ordered.



Cuttable every 1" (25 mm)



2700K



3500K



6500K

Eliminate the guesswork and get the LED that pairs perfectly with your general lighting and overall design.



No soldering required – simple FlexConnect connectors (sold separately)



Strong 300 LSE 3M™ adhesive backing

Typical Setup:

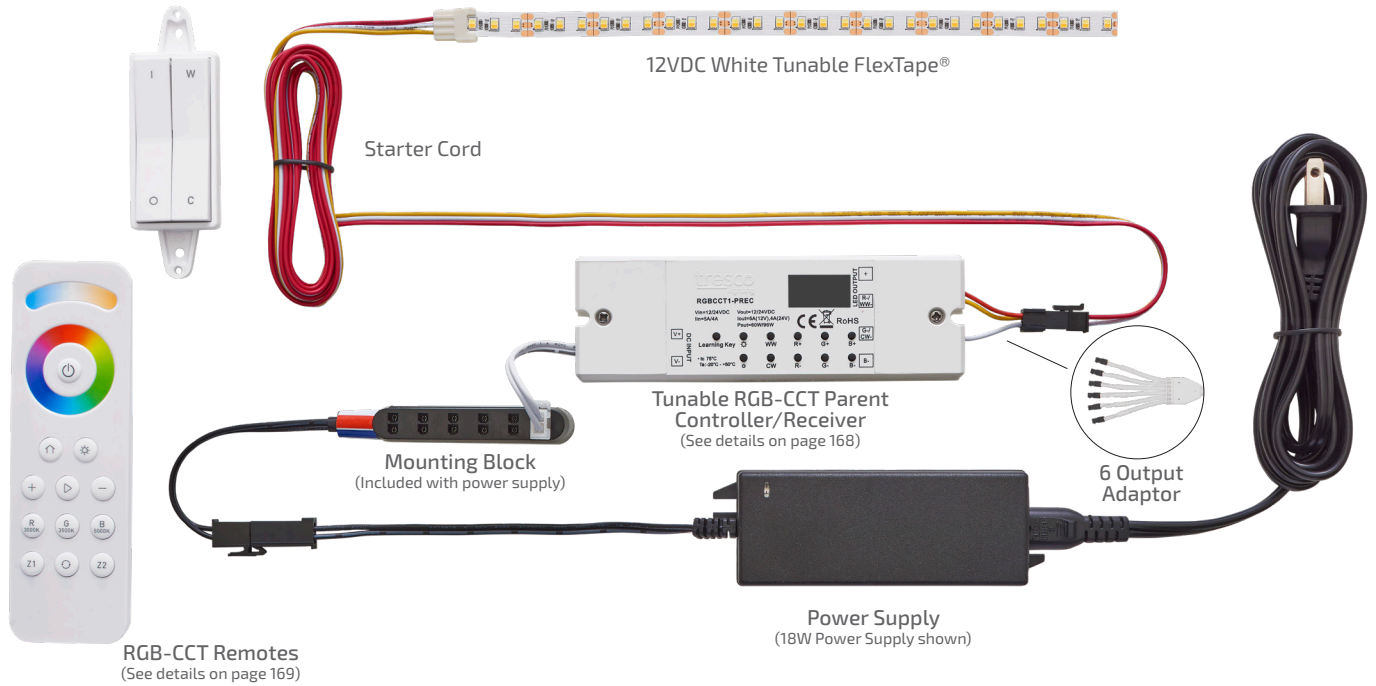

- Required
- Optional

Accessories:

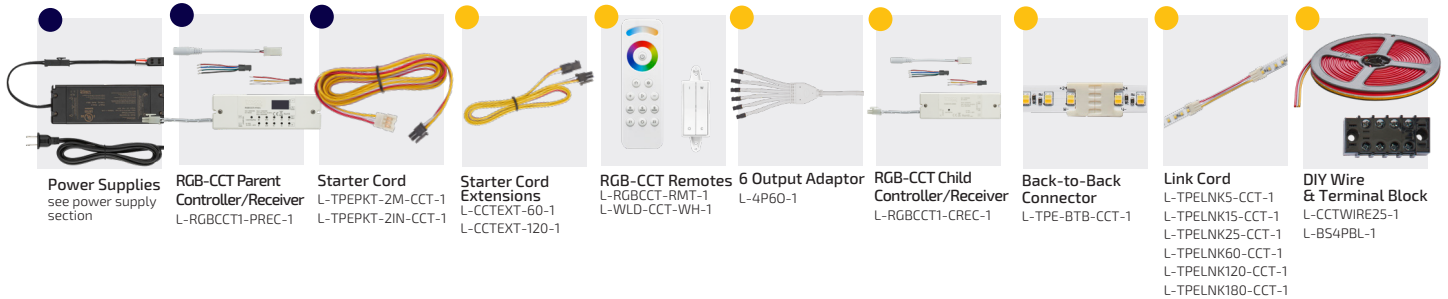

Specifications:

Wattage	Lumens	Efficacy (lm/W)	Input Voltage	Diode Life	Max Per Power Supply 60W	Max Continuous Run	Mounting	Warranty	Beam Angle												
3W/ft. (9.8W/m)	345 per ft. (1132 per m)	115	12VDC	50,000 Hours	20' (6 m)	16.4' (5 m)	Surface	5 Year													
Photometric Data					Color Temperature																
		<table border="1"> <thead> <tr> <th>Height</th> <th>Light Output</th> <th>Beam Area</th> </tr> </thead> <tbody> <tr> <td>1ft (.3 m)</td> <td>114Fc (1227lx)</td> <td>3.2ft L x 3ft W (.97 m L x .91 m W)</td> </tr> <tr> <td>3ft (.9 m)</td> <td>12.7Fc (136.7lx)</td> <td>9.7ft L x 9ft W (2.9 m L x 2.7 m W)</td> </tr> <tr> <td>6ft (1.8 m)</td> <td>3.17Fc (34.1lx)</td> <td>19.4ft L x 18.1ft W (5.9 m L x 5.5 m W)</td> </tr> </tbody> </table>	Height	Light Output	Beam Area	1ft (.3 m)	114Fc (1227lx)	3.2ft L x 3ft W (.97 m L x .91 m W)	3ft (.9 m)	12.7Fc (136.7lx)	9.7ft L x 9ft W (2.9 m L x 2.7 m W)	6ft (1.8 m)	3.17Fc (34.1lx)	19.4ft L x 18.1ft W (5.9 m L x 5.5 m W)							
Height	Light Output	Beam Area																			
1ft (.3 m)	114Fc (1227lx)	3.2ft L x 3ft W (.97 m L x .91 m W)																			
3ft (.9 m)	12.7Fc (136.7lx)	9.7ft L x 9ft W (2.9 m L x 2.7 m W)																			
6ft (1.8 m)	3.17Fc (34.1lx)	19.4ft L x 18.1ft W (5.9 m L x 5.5 m W)																			
L-FLXTPE-12CCT-1 Tested at 4600K																					

See page 122 for part numbers and descriptions



24VDC

# White Tunable FlexTape®

3W/ft.  
(9.8W/m)

345 Lumens  
per ft.  
(1132 per meter)



Changing your light source's color temperature is easy with Tresco® White Tunable (CCT) FlexTape® lighting solution. Select between warmer lighting that highlights natural wood grains and earth tones or cool lighting to highlight whites; perfect for cabinet, task or accent lighting and store fixtures. The low profile and adhesive 3M™ backing give this LED lighting solution the versatility to install in a multitude of places. Eliminate the guesswork and get the LED that pairs perfectly with your general lighting and overall design.

### Features:

115° beam angle

High output (345 lumens per ft.)

White tunable from 2700K-6500K

Sold in 16.4' (5 m) roll

Cuttable every 2" (50 mm)

No soldering required – simple FlexConnect connectors (sold separately)

Precision tunable remote controls (sold separately)

### Typical Applications:

Under Cabinet

Interior Cabinets

Accent Lighting

Displays

Task Lighting

Store fixtures

Toe kick

Soffit

Backlighting



2700K



3500K



6500K

Cuttable every 2" (50 mm)

Eliminate the guesswork and get the LED that pairs perfectly with your general lighting and overall design.



No soldering required – simple FlexConnect connectors (sold separately)



Strong 300 LSE 3M™ adhesive backing



### Dimensions:

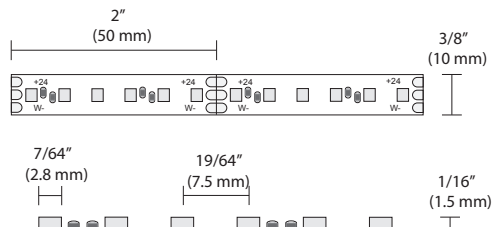

White Tunable FlexTape® can be used as a DIY option for flush and recessed Infinex. For other profiles, must be custom ordered.



Typical Setup:

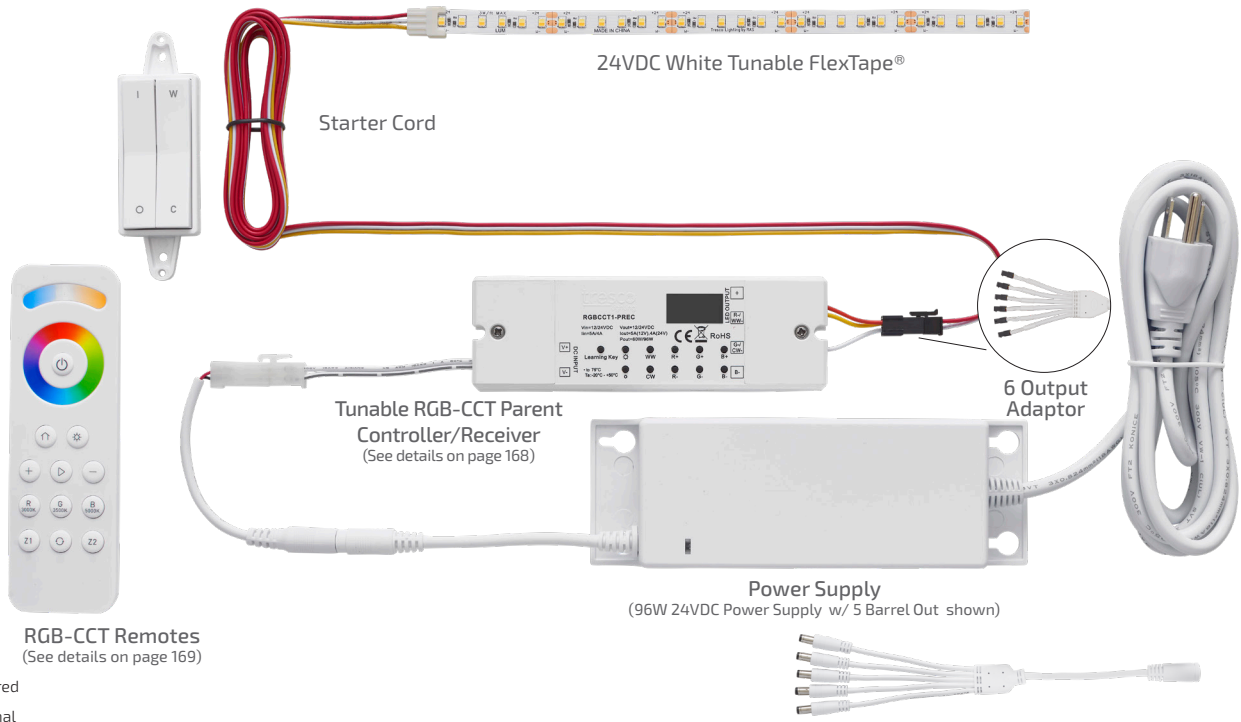

Accessories:

<b>Power Supplies</b> see power supply section	<b>RGB-CCT Parent Controller/Receiver</b> L-RGBCCT1-PREC-1	<b>Starter Cord</b> L-TPEPKT-2M-CCT-1 L-TPEPKT-2IN-CCT-1	<b>Starter Cord Extensions</b> L-CCTEXT-60-1 L-CCTEXT-120-1	<b>RGB-CCT Remotes</b> L-RGBCCT-RMT-1 L-WLD-CCT-WH-1	<b>6 Output Adaptor</b> L-4P60-1	<b>RGB-CCT Child Controller/Receiver</b> L-RGBCCT1-CREC-1	<b>Back-to-Back Connector</b> L-TPE-BTB-CCT-1	<b>Link Cord</b> L-TPELNK5-CCT-1 L-TPELNK15-CCT-1 L-TPELNK25-CCT-1 L-TPELNK60-CCT-1 L-TPELNK120-CCT-1 L-TPELNK180-CCT-1	<b>DIY Wire &amp; Terminal Block</b> L-CCTWIRE25-1 L-B54PBL-1

Specifications:

Wattage	Lumens	Efficacy (lm/W)	Input Voltage	Diode Life	Max Per Power Supply 96W	Max Continuous Run	Mounting	Warranty	Beam Angle
3W/ft. (9.8W/m)	345 per ft. (1132 per m)	115	24VDC	50,000 Hours	30'(9m)	16.4' (5 m)	Surface	5 Year	
Photometric Data					Color Temperature				
	Height	Light Output	Beam Area						
	1ft (.3 m)	114Fc (1227lx)	3.2ft L x 3ft W (.97 m L x .91 m W)		2700K   3000K   4500K   5500K   6500K				
	3ft (.9 m)	12.7Fc (136.7lx)	9.7ft L x 9ft W (2.9 m L x 2.7 m W)		Warm (2700K)   Daylight (6500K)				
6ft (1.8 m)	3.17Fc (34.1lx)	19.4ft L x 18.1ft W (5.9 m L x 5.5 m W)							
L-FLXTPE-24CCT-1 Tested at 4600K									

See page 122 for part numbers and descriptions



NEW!

24VDC

# 4W CCT Power Pockit®

4W

2700K:  
**236 Lumens**  
6500K:  
**280 Lumens**



Install now and choose the color temperature later with warm 2700K to daylight 6500K all in one fixture. A high output, slim profile and recess or surface mount capability make this our most versatile puck for even illumination.

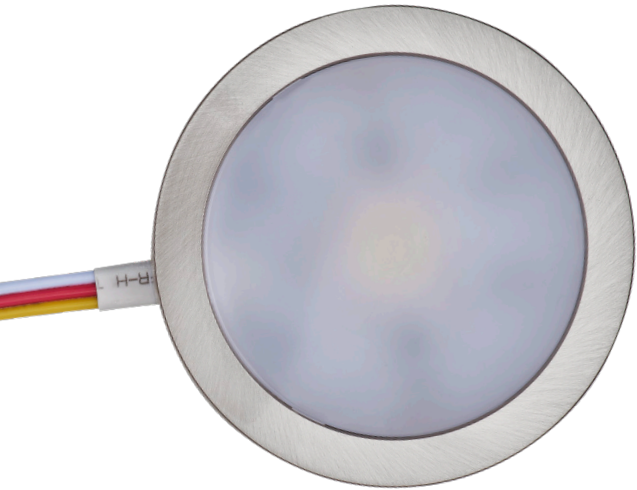

### Features:

1/2" (13 mm) depth

105-degree beam spread

High Uniform Output - no "dots"

Aluminum die cast construction

White Tunable from 2700K-6500K

Precision tunable remote controls (sold separately)

Recess or surface mount

### Typical Applications:

Displays or store fixtures

Interior Cabinets/Shelving

Under Cabinets

Task or flood lighting



White Tunable from 2700K-6500K



### Available Finishes:



Black (BL)



Nickel (NI)



White (WH)

### Dimensions:

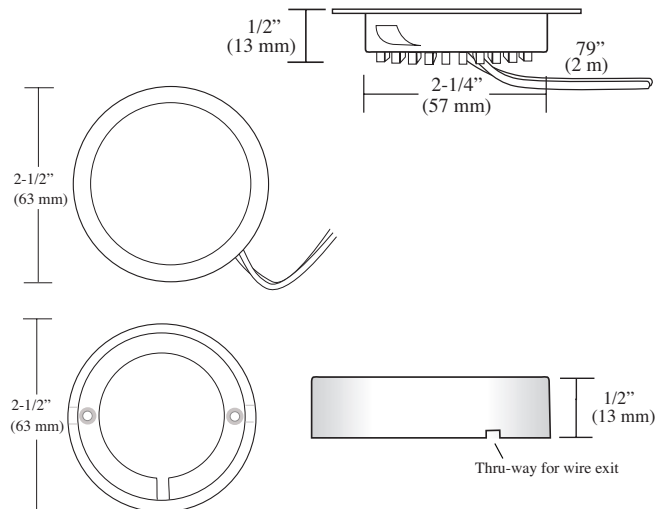

Available in multiple finishes with milk lens



Thin profile: Just 1/2" (13 mm) depth when recessing or surface mounting

Typical Setup:

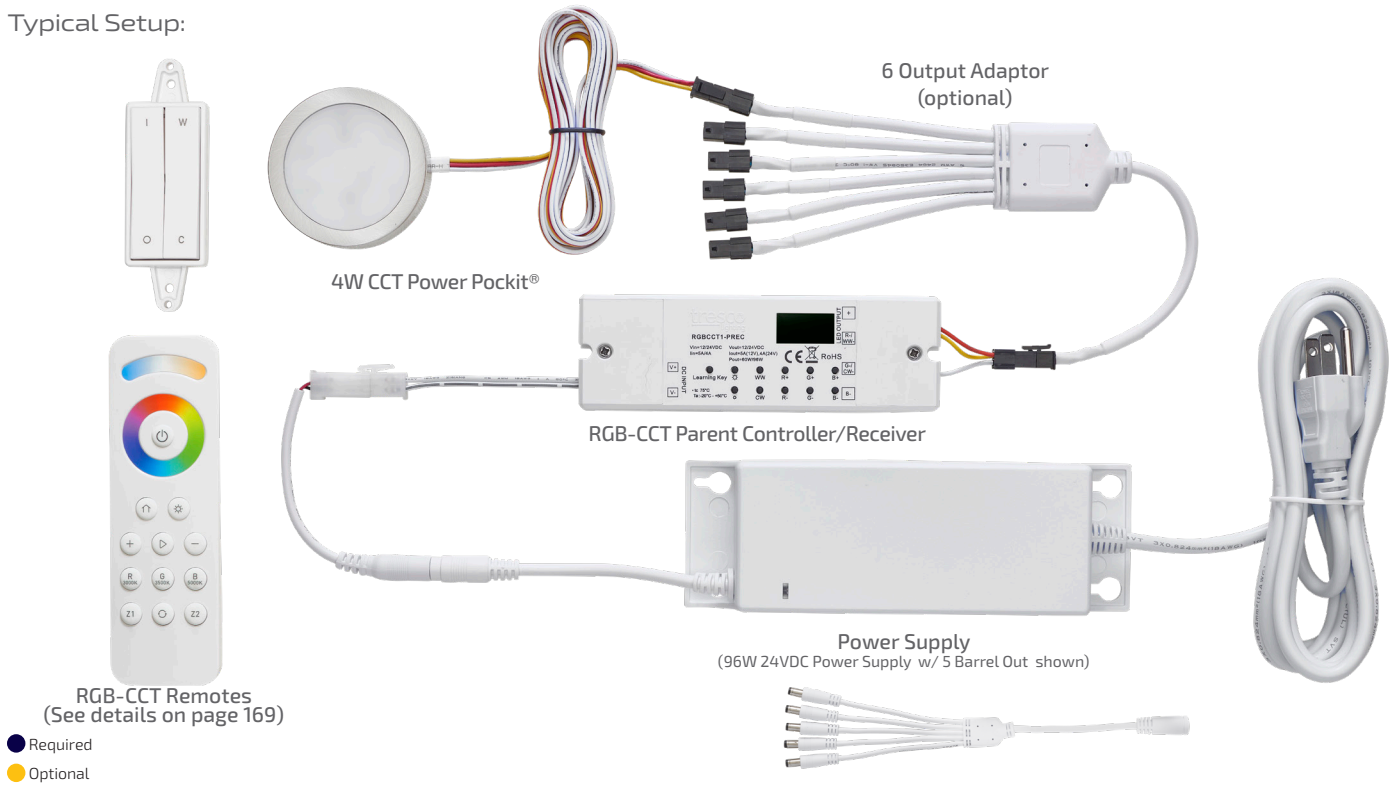

Accessories:

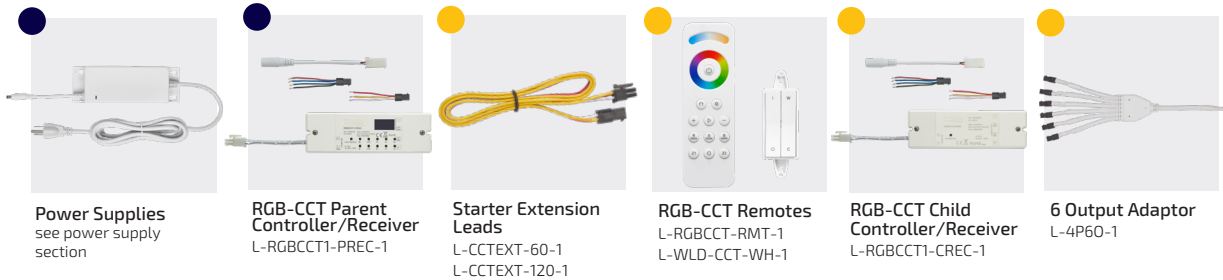

Specifications:

Wattage	Lumens	Efficacy (lm/W)	Input Voltage	Diode Life	Max Per 96W Power Supply	Mounting	Warranty	Beam Angle
4W	2700K: 236 6500K: 280	2700K: 59 6500K: 70	24VDC	50,000 Hours	24 Fixtures	Recess/ Surface	5 Year	
Photometric Data					Color Temperature			
	Height	Light Output	Beam Area					
	1ft (.3 m)	93.7Fc (1009lx)	2.6ft L x 2.7ft W (.8 m L x .8 m W)					
	3ft (.9 m)	10.4Fc (112lx)	7.9ft L x 8.0ft W (2.4 m L x 2.4 m W)					
	6ft (1.8 m)	2.6Fc (28lx)	15.8ft L x 15.9ft W (4.8 m L x 4.8 m W)					
L-POC-4CCT24-NI-1 Tested at 6500K								

See page 123 for part numbers and descriptions

- Required
- Optional

## ● 12/24VDC White Tunable FlexTape®

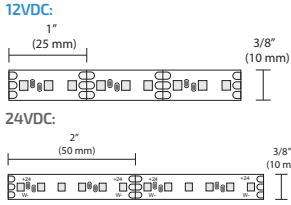

### Part #

### Description

L-FLXTPE-12CCT-1	12VDC 3W/FT CCT FlexTape® 16.4' (5 m) Roll
L-FLXTPE-24CCT-1	24VDC 3W/FT CCT FlexTape® 16.4' (5 m) Roll

Maximum continuous run is 16.4' (5 m). Maximum per power supply is 12VDC: 20' (6 m), 24VDC: 30' (5 m). Mounts with adhesive backing. 12VDC is cuttable every 1" (25 mm), 24VDC is cuttable every 2" (50 mm). To be used on clean, smooth surfaces. Pressure must be applied for proper 3M™ tape adhesion.

## ● 12/24VDC Power Supplies



**For details see Power Supplies on Page 150.**

Power supplies for 12VDC work with 12VDC CCT FlexTape®, Power supplies for 24VDC work with 24VDC CCT FlexTape®

## ● 12/24VDC CCT Starter Cord

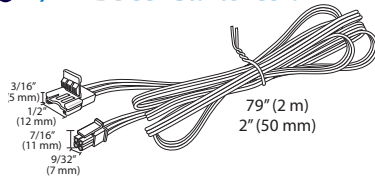

### Part #

### Description

L-TPEPKT-2M-CCT-1	2 m (79") CCT FlexTape® Starter Lead
L-TPEPKT-2IN-CCT-1	50 mm (2") CCT FlexTape® Starter Lead

5/8" (16 mm) hole required.  
Maximum linear run of White Tunable FlexTape® LED from one starter cord is 16.4' (5 m).

## ● 12/24VDC CCT Back-to-Back Connector

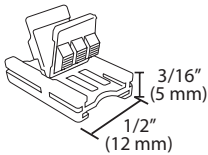

### Part #

### Description

L-TPE-BTB-CCT-1	CCT FlexTape® Back-to-Back Connector
-----------------	--------------------------------------

## ● 12/24VDC CCT Link Cords

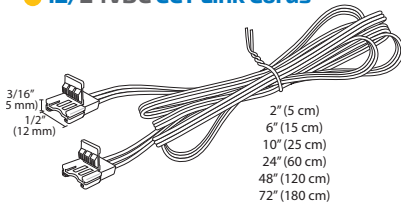

### Part #

### Description

L-TPELNK5-CCT-1	5 cm (2") CCT FlexTape® Link Cord
L-TPELNK15-CCT-1	15 cm (6") CCT FlexTape® Link Cord
L-TPELNK25-CCT-1	25 cm (10") CCT FlexTape® Link Cord
L-TPELNK60-CCT-1	50 cm (24") CCT FlexTape® Link Cord
L-TPELNK120-CCT-1	120 cm (48") CCT FlexTape® Link Cord
L-TPELNK180-CCT-1	180 cm (72") CCT FlexTape® Link Cord

## ● 12/24VDC CCT DIY

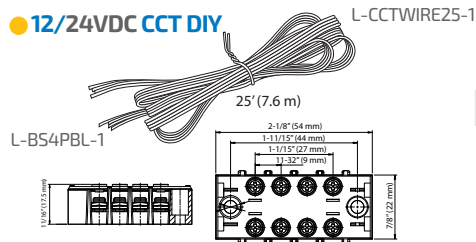

### Part #

### Description

L-CCTWIRE25-1	25' (7.6 m) 20AWG CCT Wire Roll
L-BS4PBL-1	12/24VDC Barrier Splice 4 Position, Black



## ● 24VDC 4W CCT Power Pockit®

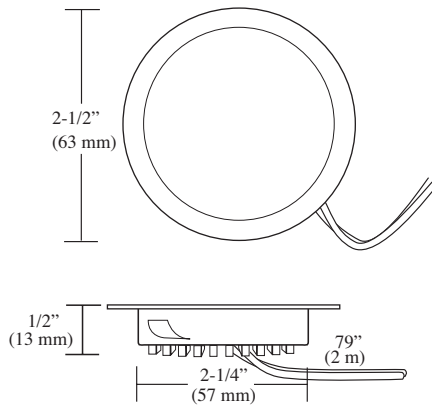

### Part #

Part #	Description
L-POC-4CCT24-BL-1	24VDC 4W CCT Power Pockit®, Black
L-POC-4CCT24-NI-1	24VDC 4W CCT Power Pockit®, Nickel
L-POC-4CCT24-WH-1	24VDC 4W CCT Power Pockit®, White

2-1/4" (57 mm) hole required for recessed mounting.

4W CCT Power Pockit® includes surface mount ring and attached 79" (2 m) input lead with 4-pin connector.

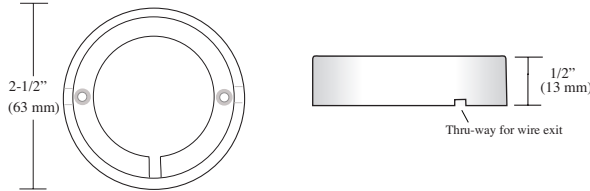

## ● 24VDC Power Supplies



For details see Power Supplies on Page 150.

## ● 12/24VDC RGB-CCT Controller/Receivers

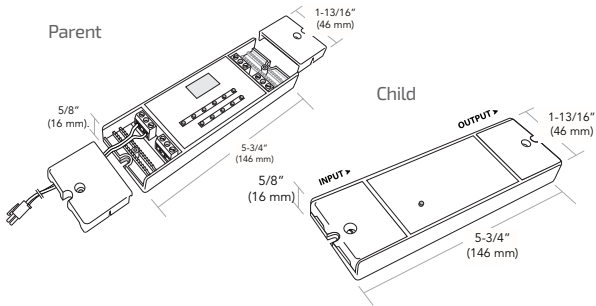

### Part #

Part #	Description
L-RGBCCT1-PREC-1	12/24VDC RGB-CCT Parent Controller/Receiver
L-RGBCCT1-CREC-1*	12/24VDC RGB-CCT Child Controller/Receiver

\*Child Receiver is optional.

## ● 12/24VDC RGB-CCT Remotes

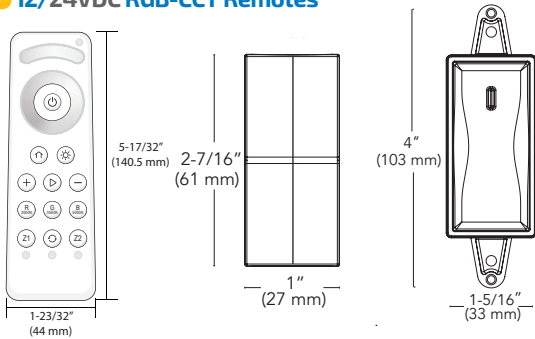

### Part #

Part #	Description
L-RGBCCT-RMT-1	RGB-CCT Wireless Remote
L-WLD-CCT-WH-1	CCT FREEDiM Deco Wall Dimmer, White

## ● 12/24VDC CCT Starter Extension Leads

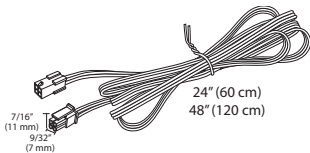

### Part #

Part #	Description
L-CCTEXT-60-1	60 cm (24") CCT FlexTape® Starter Extension Lead
L-CCTEXT-120-1	120 cm (48") CCT FlexTape® Starter Extension Lead

## ● 12/24VDC 6 Output Adaptor

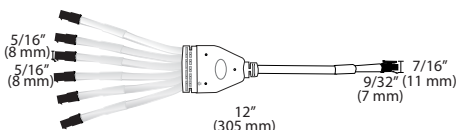

### Part #

Part #	Description
L-4P60-1	4 Position, 6 Output Adaptor, White

Use to connect up to (6) starter cords to the same parent or child controller/receiver for uniform color temperature and control.





ARPO

ARPO  
CONSIGLIA  
SUI  
VITIGLI

A



12VDC  
24VDC

RGB TUNABLE





12VDC

# RGB Tunable FlexTape®

BALANCE

4.4W/ft.  
(14.4W/m)

Red	Green	Blue
48 Lumens per ft. (157 per meter)	121 Lumens per ft. (397 per meter)	35 Lumens per ft. (115 per meter)



Tresco®'s RGB Balance FlexTape® goes the distance, with 16 million color variations and On-Board Constant Current Regulators creating consistent dramatic lighting is a reality. Created for high-end projects including residential, hospitality and commercial.

### Why Balance

All tape lighting has inherent voltage drop. This voltage drop can cause color shift in longer runs of RGB. The On-Board Constant Current Regulators prevent this from happening resulting in balanced color from start to finish.

### Features:

120° beam angle

4.4W/ft.

Sold in 13' (4 m) roll

Cuttable every 1-5/8" (42 mm)

No soldering required – simple FlexConnect connectors (sold separately)

Precision tunable remote controls (sold separately)

### Typical Applications:

Under Cabinet

Interior Cabinets

Accent Lighting

Displays

Task Lighting

Store fixtures

Toe kick

Soffit

Backlighting



16 million color combinations

Cuttable every 1-5/8" (42 mm)

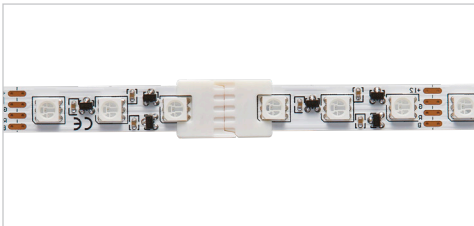

No soldering required – simple FlexConnect connectors (sold separately)



Strong 300 LSE 3M™ adhesive backing



### Dimensions:

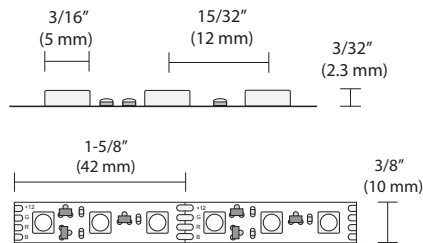







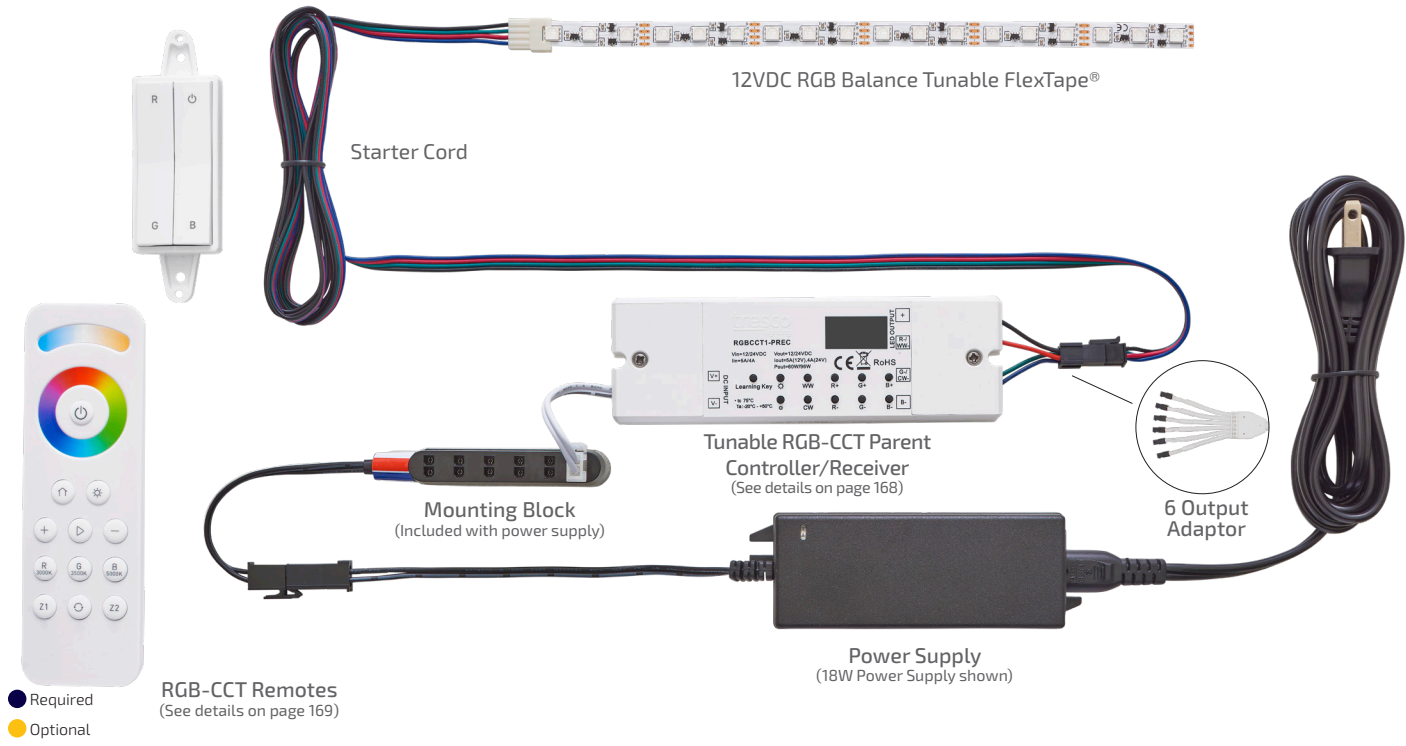

RGB Tunable FlexTape® can be used as a DIY option for flush and recessed Infinix. For other profiles, must be custom ordered.

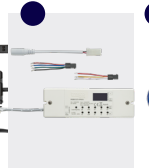

Typical Setup:

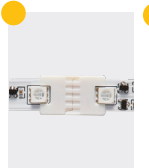
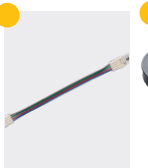

Accessories:

									
Power Supplies see power supply section	RGB-CCT Parent Controller/Receiver L-RGBCCT1-PREC-1	Starter Cord L-TPEPKT-2M-RGB-1 L-TPEPKT-2IN-RGB-1	Starter Cord Extensions L-RGBEXT-60-1 L-RGBEXT-120-1	RGB-CCT Remotes L-RGBCCT-RMT-1 L-WLD-RGB-WH-1	6 Output Adaptor L-4P60-1	RGB-CCT Child Controller/Receiver L-RGBCCT1-CREC-1	Back-to-Back Connector L-TPE-BTB-RGB-1	Link Cord L-TPELNK5-RGB-1 L-TPELNK15-RGB-1 L-TPELNK25-RGB-1 L-TPELNK60-RGB-1 L-TPELNK120-RGB-1 L-TPELNK180-RGB-1	DIY Wire & Terminal Block L-RGBWIRE25-1 L-B54PBL-1

Specifications:

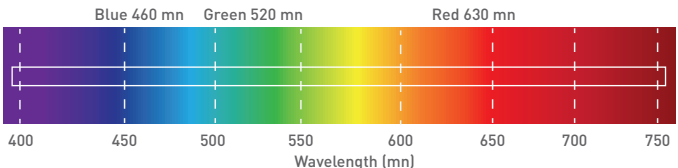
Wattage	Lumens	Input Voltage	Diode Life	Max Per Power Supply 60W	Max Continuous Run	Mounting	Warranty	Beam Angle
4.4W/ft. (14.4W/m)	Red: 48 per ft. (157 per m) Green: 121 per ft. (397 per m) Blue: 35 per ft. (115 per m)	12VDC	50,000 Hours	13' (4 m)	13' (4 m)	Surface	5 Year	
 <p>Blue 460 nm    Green 520 nm    Red 630 nm</p> <p>400    450    500    550    600    650    700    750</p> <p>Wavelength (nm)</p> <p>Wavelengths are averages.</p>								

See page 132 for part numbers and descriptions



24VDC

# RGB Tunable FlexTape®

**BALANCE**

**4.4W/ft.**  
(14.4W/m)

Red	Green	Blue
51 Lumens per ft. (167 per meter)	117 Lumens per ft. (384 per meter)	41 Lumens per ft. (135 per meter)



Tresco®'s RGB Balance FlexTape® goes the distance, with 16 million color variations and On-Board Constant Current Regulators creating consistent dramatic lighting is a reality. Created for high-end projects including residential, hospitality and commercial

### Why Balance

All tape lighting has inherent voltage drop. This voltage drop can cause color shift in longer runs of RGB. The On-Board Constant Current Regulators prevent this from happening resulting in balanced color from start to finish.

### Features:

120° beam angle

4.4W/ft.

Sold in 16.4' (5 m) roll

Cuttable every 3-1/4" (83 mm)

No soldering required – simple FlexConnect connectors (sold separately)

Precision tunable remote controls (sold separately)

### Typical Applications:

Under Cabinet

Interior Cabinets

Accent Lighting

Displays

Task Lighting

Store fixtures

Toe kick

Soffit

Backlighting



### Dimensions:

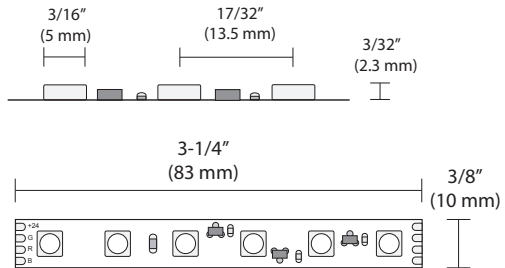

RGB Tunable FlexTape® can be used as a DIY option for flush and recessed Infinix. For other profiles, must be custom ordered.



Cuttable every 3-1/4" (83 mm)



16 million color combinations



No soldering required – simple FlexConnect connectors (sold separately)



Strong 300 LSE 3M™ adhesive backing

Typical Setup:

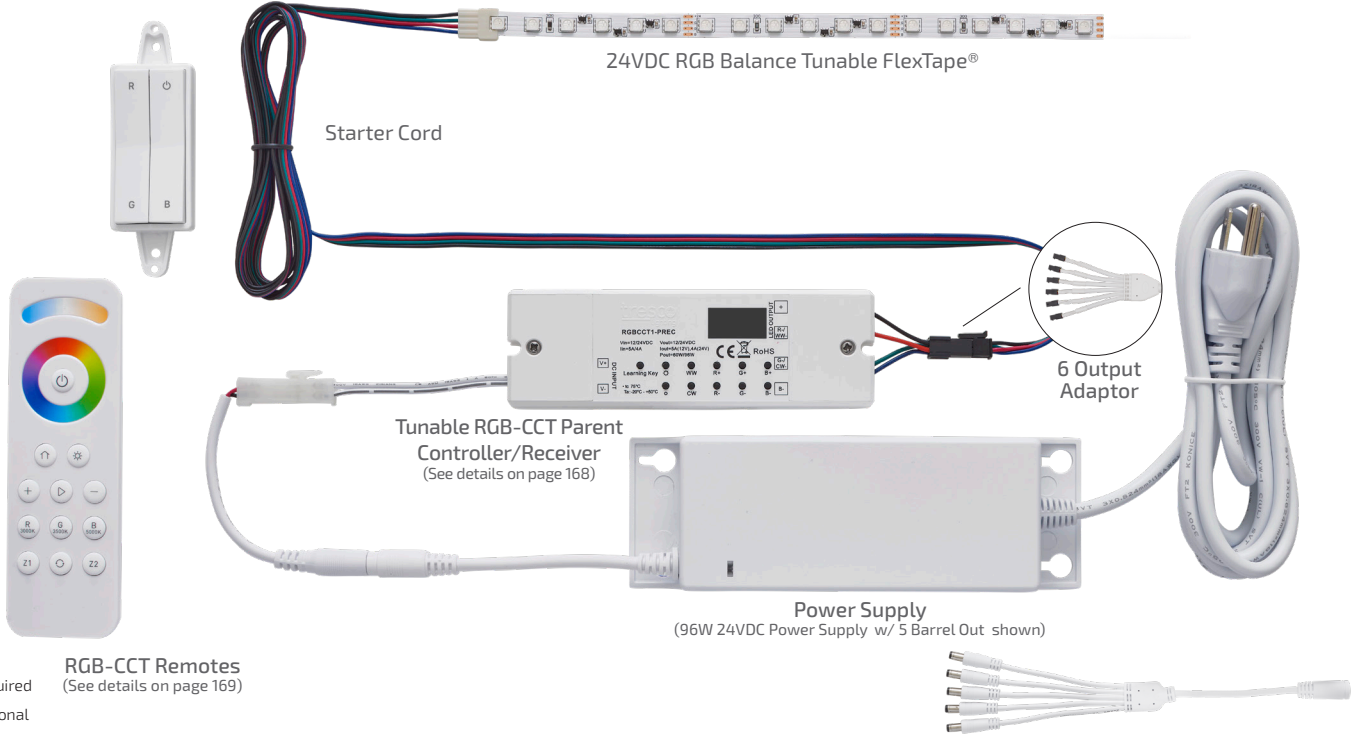

Accessories:

Power Supplies see power supply section	RGB-CCT Parent Controller/Receiver L-TPEPKT-2M-RGB-1 L-RGBCCT1-PREC-1	Starter Cord L-TPEPKT-2IN-RGB-1	Starter Cord Extensions L-RGBEXT-60-1 L-RGBEXT-120-1	RGB-CCT Remotes L-RGBCCT-RMT-1 L-WLD-RGB-WH-1	6 Output Adaptor L-4P60-1	RGB-CCT Child Controller/Receiver L-RGBCCT1-CREC-1	Back-to-Back Connector L-TPE-BTB-RGB-1	Link Cord L-TPELNK5-RGB-1 L-TPELNK15-RGB-1 L-TPELNK25-RGB-1 L-TPELNK60-RGB-1 L-TPELNK120-RGB-1 L-TPELNK180-RGB-1	DIY Wire & Terminal Block L-RGBWIRE25-1 L-BS4PBL-1

Specifications:

Wattage	Lumens	Input Voltage	Diode Life	Max Per Power Supply 96W	Max Continuous Run	Mounting	Warranty	Beam Angle
4.4W/ft. (14.4W/m)	Red: 51 per ft. (167 per m) Green: 117 per ft. (384 per m) Blue: 41 per ft. (135 per m)	24VDC	50,000 Hours	21' (6.4 m)	16.4' (5 m)	Surface	5 Year	120°

Blue 460 nm    Green 520 nm    Red 630 nm

400    450    500    550    600    650    700    750

Wavelength (nm)

Wavelengths are averages.

See page 132 for part numbers and descriptions



24VDC

# RGB Tunable FlexTape®

STANDARD

4.4W/ft.  
(14.4W/m)

Red	Green	Blue
51 Lumens per ft. (167 per meter)	117 Lumens per ft. (384 per meter)	41 Lumens per ft. (135 per meter)



Creating dramatic lighting with 16 million colors is a reality with Tresco® Lighting's RGB Standard color-changing FlexTape®. Created and priced for everyday projects.



16 million color combinations

Cuttable every 2-13/16" (71 mm)



No soldering required – simple FlexConnect connectors (sold separately)



Strong 300 LSE 3M™ adhesive backing

### Features:

120° beam angle

4.4W/ft.

Sold in 16.4' (5 m) roll

Cuttable every 2-13/16" (71 mm)

No soldering required – simple FlexConnect connectors (sold separately)

Precision tunable remote controls (sold separately)

### Typical Applications:

Under Cabinet

Interior Cabinets

Accent Lighting

Displays

Task Lighting

Store fixtures

Toe kick

Soffit

Backlighting



### Dimensions:

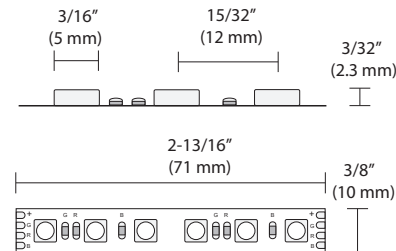

RGB Tunable FlexTape® can be used as a DIY option for flush and recessed Infinix. For other profiles, must be custom ordered.



Typical Setup:

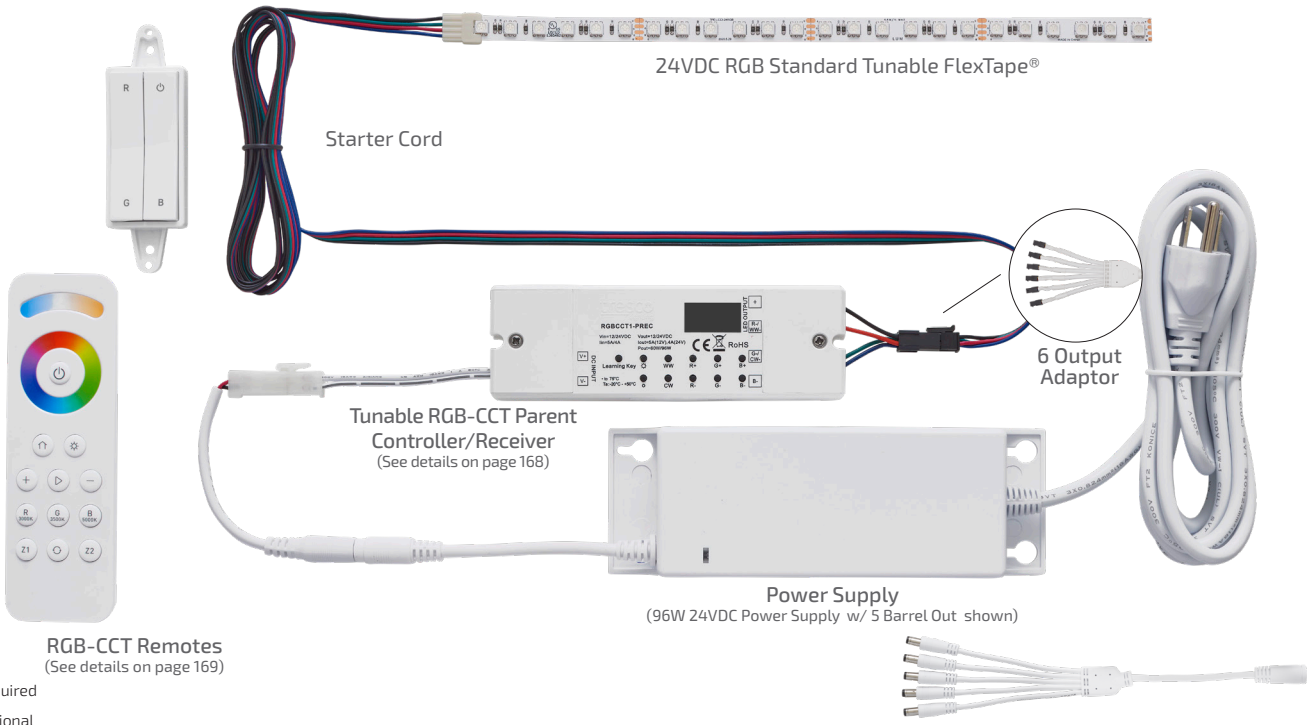

Accessories:

Power Supplies see power supply section	RGB-CCT Parent Controller/Receiver L-RGBCCT1-PREC-1	Starter Cord L-TPEPKT-2M-RGB-1 L-TPEPKT-2IN-RGB-1	Starter Cord Extensions L-RGBEXT-60-1 L-RGBEXT-120-1	RGB-CCT Remotes L-RGBCCT-RMT-1 L-WLD-RGB-WH-1	6 Output Adaptor L-4P60-1	RGB-CCT Child Controller/Receiver L-RGBCCT1-CREC-1	Back-to-Back Connector L-TPE-BTB-RGB-1	Link Cord L-TPELNK5-RGB-1 L-TPELNK15-RGB-1 L-TPELNK25-RGB-1 L-TPELNK60-RGB-1 L-TPELNK120-RGB-1 L-TPELNK180-RGB-1	DIY Wire & Terminal Block L-RGBWIRE25-1 L-BS4PBL-1

Specifications:

Wattage	Lumens	Input Voltage	Diode Life	Max Per Power Supply 96W	Max Continuous Run	Mounting	Warranty	Beam Angle
4.4W/ft. (14.4W/m)	Red: 51 per ft. (167 per m) Green: 117 per ft. (384 per m) Blue: 41 per ft. (135 per m)	24VDC	50,000 Hours	21' (6.4 m)	16.4' (5 m)	Surface	5 Year	

  

Wavelengths are averages.

See page 132 for part numbers and descriptions

- Required
- Optional

## 12/24VDC RGB Tunable FlexTape®

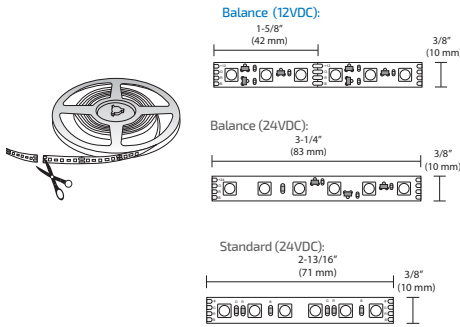

Part #	Description
L-FLXTPE-12RGB-1	12VDC 4.4W/FT RGB FlexTape® W/IC 13' (4 m) Roll
L-FLXTPE-24RGB-1	24VDC 4.4W/FT RGB FlexTape® W/IC 16.4' (5 m) Roll
L-TPELED-24RGB-1	24VDC 4.4W/FT RGB Tape LED 16.4' (5 m) Roll

Maximum continuous run is 13' (4 m) for 12VDC and 16.4' (5 m) for 24VDC. Maximum per power supply is 12VDC: 13' (4 m), 24VDC: 16.4' (5 m). Mounts with adhesive backing. Standard 24VDC is cuttable every 2-13/16" (71 mm), RGB Balance 12VDC is cuttable every 1-5/8" (42 mm), RGB Balance 24VDC is cuttable every 3-1/4" (83 mm). To be used on clean, smooth surfaces. Pressure must be applied for proper 3M™ tape adhesion.

## 12/24VDC Power Supplies



For details see Power Supplies on Page 150.

Power supplies for 12VDC work with 12VDC RGB FlexTape®, Power supplies for 24VDC work with 24VDC RGB FlexTape®

## 12/24VDC RGB Starter Cord

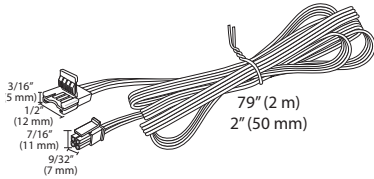

Part #	Description
L-TPEPKT-2IN-RGB-1	50 mm (2") RGB FlexTape® Starter Lead
L-TPEPKT-2M-RGB-1	2 m (79") RGB FlexTape® Starter Lead

5/8" (16 mm) hole required.  
Maximum linear run of RGB Tunable FlexTape® LED from one starter cord is 16.4' (5 m).  
*New and Improved Connectors Coming Soon.*

## 12/24VDC RGB-CCT Controller/Receivers

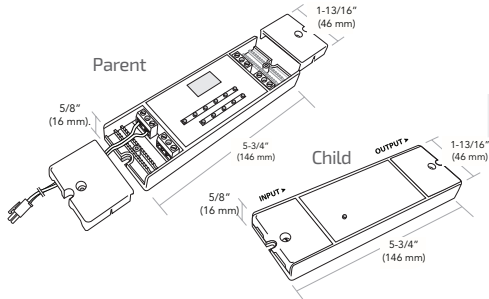

Part #	Description
L-RGBCCT1-PREC-1	12/24VDC RGB-CCT Parent Controller/Receiver
L-RGBCCT1-CREC-1*	12/24VDC RGB-CCT Child Controller/Receiver

\*Child Receiver is optional  
6 output adaptor sold separately.

## 12/24VDC RGB-CCT Remotes

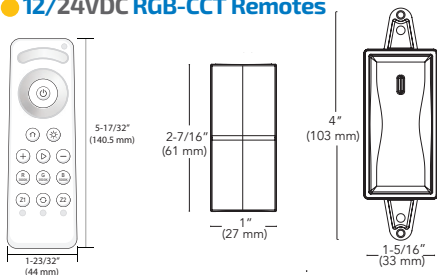

Part #	Description
L-RGBCCT-RMT-1	RGB-CCT Wireless Remote
L-WLD-RGB-WH-1	RGB FREEDiM Deco Wall Dimmer, White

## ● 12/24VDC RGB Starter Extension Leads

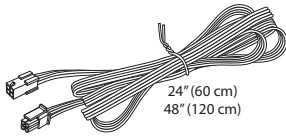

Part #	Description
L-RGBEXT-60-1	60 cm (24") RGB FlexTape® Starter Extension Lead
L-RGBEXT-120-1	120 cm (48") RGB FlexTape® Starter Extension Lead

## ● 12/24VDC RGB Back-to-Back Connector

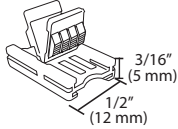

Part #	Description
L-TPE-BTB-RGB-1	RGB FlexTape® Back-to-Back Connector

*New and Improved Connectors Coming Soon.*

## ● 12/24VDC 6 Output Adaptor

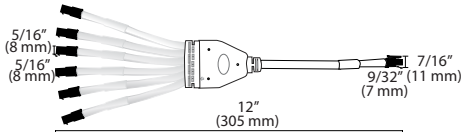

Part #	Description
L-4P60-1	4 Position, 6 Output Adaptor, White

Use to connect up to (6) color starter cords to the same parent or child controller/receiver for uniform RGB and control.

## ● 12/24VDC RGB Link Cord

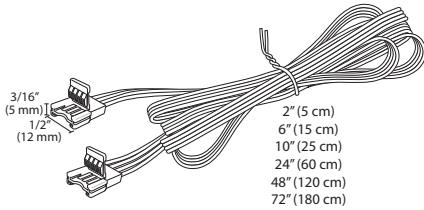

Part #	Description
L-TPELNK5-RGB-1	5 cm (2") RGB FlexTape® Link Cord
L-TPELNK15-RGB-1	15 cm (6") RGB FlexTape® Link Cord
L-TPELNK25-RGB-1	25 cm (10") RGB FlexTape® Link Cord
L-TPELNK60-RGB-1	60 cm (24") RGB FlexTape® Link Cord
L-TPELNK120-RGB-1	120 cm (48") RGB FlexTape® Link Cord
L-TPELNK180-RGB-1	180 cm (72") RGB FlexTape® Link Cord

*New and Improved Connectors Coming Soon.*

## ● 12/24VDC RGB DIY

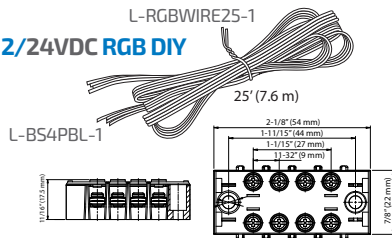

Part #	Description
L-RGBWIRE25-1	25' (7.6 m) 22AWG RGB Wire Roll
L-BS4PBL-1	12/24VDC Barrier Splice 4 Position, Black





6

Theory

6



12VDC

24VDC

# EXTRUSION

12VDC  
24VDC

# Infinex

Infinex is the innovative, patented, LED aluminum extrusion system by Tresco® Lighting. Gone are the days of set fixture sizes, simply choose your style, cut to desired length and assemble to create a customized LED fixture. Designed by our in-house engineers and made in the USA, Infinex carries a UL safety certification and is available in six profiles with an array of installation options.

Infinex is designed for easy DIY application and we also offer prefabricated custom solutions.

**US PATENT NO: D783,533 and 9,618,194**

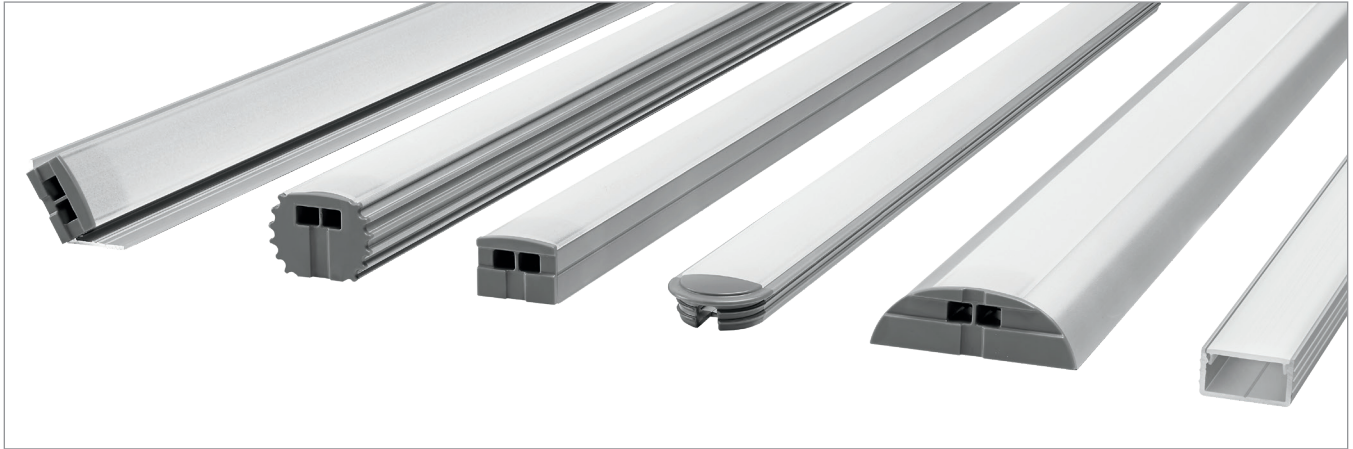

6 profiles to choose from



FlexTape® slides into proprietary power feed end cap

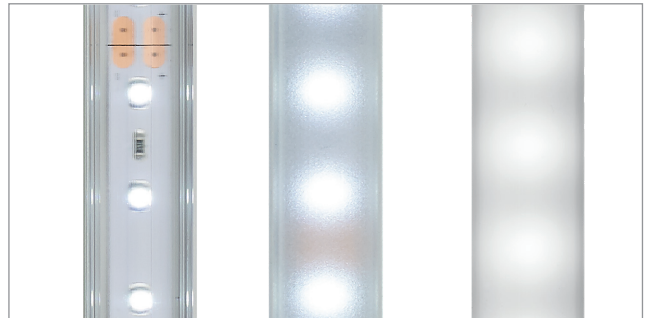

Clear, frosted and milk diffusers snap on/off for easy installation and removal.

## Mounting Types:

### SCREW



### U-CLIP

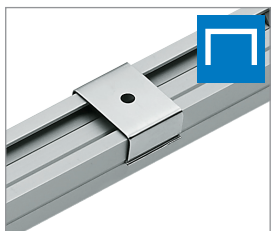

### SWIVEL CLIP

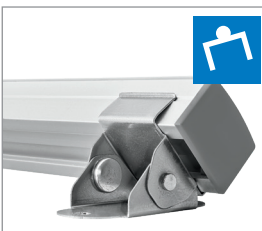

### MAGNET



### RECESSED

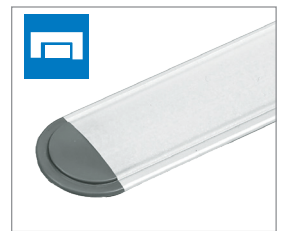

See individual profiles for mounting options available



System Components

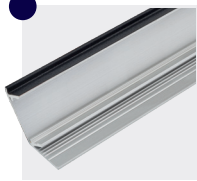

**Extrusions**

- L-XANG72-SC-1
- L-XANG72-\*\*-1
- L-XCRV72-SC-1
- L-XCRV72-\*\*-1
- L-XREC72-SC-1
- L-XREC94-SC-1
- L-XREC72-BL-1
- L-XREC94-BL-1
- L-XRND72-SC-1
- L-XRND72-BL-1
- L-XSQR72-SC-1
- L-XSQR72-\*\*-1
- L-XFL72-SC-1
- L-XFL94-SC-1



**Diffusers**

- L-X72-DIFF-CL-1
- L-X72-DIFF-FR-1
- L-X72-DIFF-MLK-1
- L-X94-DIFF-CL-1
- L-X94-DIFF-FR-1
- L-X94-DIFF-MLK-1

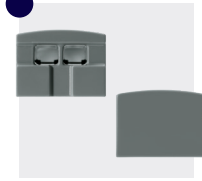

**End Cap Sets**

- L-XANGECP-GY-1
- L-XANGECP-\*\*-1
- L-XCRVECP-GY-1
- L-XCRVECP-\*\*-1
- L-XRECECP-GY-1
- L-XRECECP-BL-1
- L-XRNDECP-GY-1
- L-XRNDECP-BL-1
- L-XSQRECP-GY-1
- L-XSQRECP-\*\*-1



**Starter Cord**

- 12VDC:
- L-XPKT-2M-WH-1
- L-XPKT-2IN-WH-1
- L-XPKT-2M-BL-1
- L-XPKT-2IN-BL-1
- 24VDC:
- L-24XPKT-2M-BL-1
- L-24XPKT-2M-WH-1



**Couplers**

- L-EXTBTB10-1

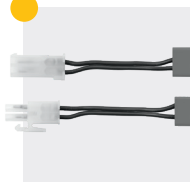

**Linking Cords**

- L-XLNK-15-\*\*-1
- L-XLNK-25-\*\*-1
- L-XLNK-60-\*\*-1
- L-XLNK-120-\*\*-1
- L-XLNK-180-\*\*-1

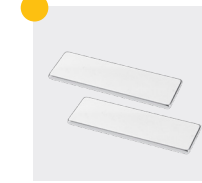

**Mounting Plates**

- L-EXTMP-VHB-1



**U-Clips**

- L-XRND-UCLP-1
- L-XSQR-UCLP-1
- L-XSQRSWCLP-1



**Magnet**

- L-XRM42-155-1

**CUSTOM SOLUTIONS**

Take control of your lighting through our custom Infinex solutions. From length, to light output, to screw versus magnetic mounting, you dictate the options of your unique fixture. Once decided, we will manufacture it in our USA headquarters. No more worries about international shipping delays or extended holidays. Every light is quality checked and bears the cULus marking denoting its safe operation. Don't settle for something "close", choose Infinex and get exactly what you want. Go to [trescolighting.com](http://trescolighting.com) to submit your project and receive a custom quote.

**CUSTOM FULLY ASSEMBLED FIXTURES**

**NO MINIMUM REQUIREMENT**

**MADE IN THE U.S.A. AND SHIPS WITHIN 7 DAYS!**



- 6 unique profiles
- 30 light output options
- Black or white cords (multiple lengths)
- 4"- 96" (101 mm - 2438 mm) fixture lengths in 1/16" (1.6 mm) increments
- 3 diffuser options (clear, frosted, milk)
- Bulk, individual, or kit packaged
- No minimum quantity required
- Quick turnaround



**NEW!** INFINEX INTEGRATED CONTROL OPTIONS



Dimmer Only

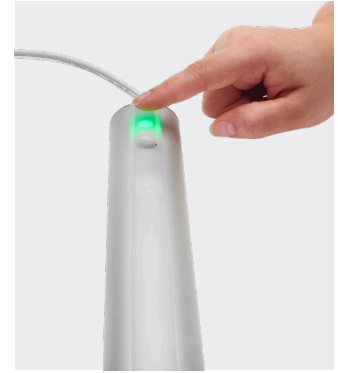

Dimmer/Motion Combo

**Features:**

Controls are elegantly and fully integrated into the made-to-order Infinex fixture

ON/OFF and dimming controls use a glowing digital button for easy visual recognition

An optional fully-integrated occupancy sensor available to automatically turn the fixture off after 30-minutes of no activity or Tresco® can customize the desired time delay

Easily switch between manual and occupancy sensor modes

Returns to last setting when turned on

**Typical Applications:**

- Hospitality applications utilizing the integrated occupancy sensor for for:
  - Hotel or hospital closet, vanity or headboard lighting
  - Task lighting for nurses' stations
- Attach under: furniture and bathroom cabinetry
- Office furniture: task lighting under overhead shelves, bins, cabinets and privacy booths
- Under residential or commercial cabinetry to illuminate a countertop and/or backsplash
- Retail: utilize the integrated occupancy sensor to turn display lighting on when customers approach

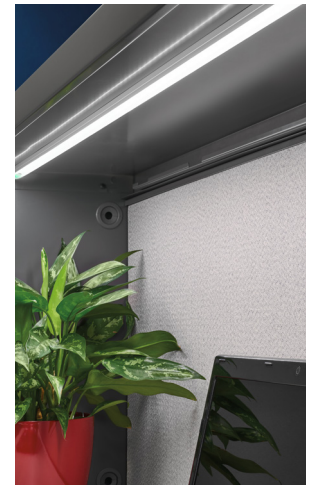

**Dimmer Only**

- Touch ON/OFF
- Gradual dimming from 100%-5%
- Power failure memory (retains last setting)
- 10 hour automatic energy saving shutoff

**Dimmer/Motion Sensor Combo**

- 4 step dimming 100/75/50/25
- 30 minute preset motion sensor\*
- Motion sensor can be deactivated
- Dimmer works in motion sensor mode or standalone mode
- 10 hour automatic energy saving shutoff in dimmer only mode

\*Motion sensor time can be customized by Tresco® Lighting

**Not sold individually for DIY Infinex**

# BLEND SERIES



See "At a Glance" chart for extrusion styles and finishes available



Available in a variety of finishes. Custom finishes also available

## In Stock

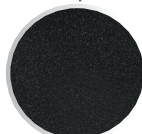

Black (BL)



Dark Cherry (DC)



Natural Soft Maple (NSM)



Satin Nickel (SC)

Sample rings available



## Available with 1000 Ft. Min. Order



Medium Cherry



Light Cherry



Contemporary Cherry



Walnut



Natural Oak



Dark Oak



Pear



Color Matching\*

\* Color Matching will match any color sample and is available with 1000 ft. minimum order



# DIY INFINEX

## 1 DESIGN YOUR LIGHT

### 1a PROFILE SHAPE

6 unique profiles to choose from!

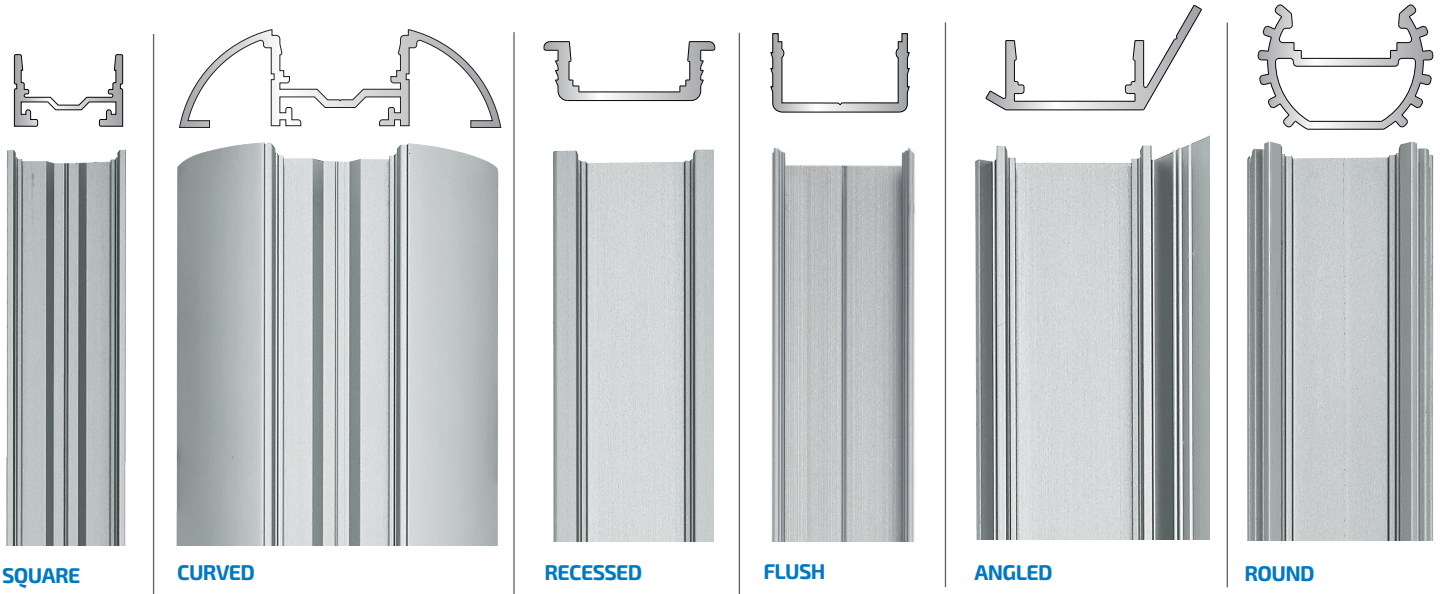

### 1b PICK YOUR FINISH

Available in a variety of finishes. Custom finishes also available. Not all finishes available with all shapes.



### 1c DIFFUSER

Clear, frosted and milk diffusers



### 1d LIGHT OUTPUT

Ranging from 1.5W to 5.5W



### 1e STARTER CORD



Infinex Starter Cord



Standard FlexTape® Starter Cord for Recessed or Flush

### 1f MOUNTING



See individual profiles for mounting options available



## EXTRUSION OPTIONS AT A GLANCE

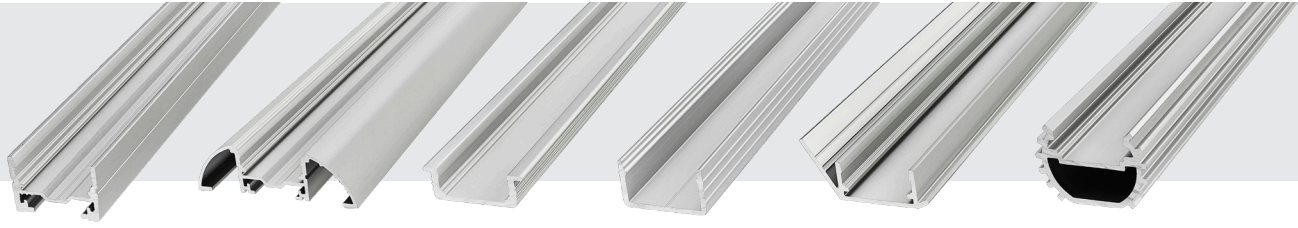

	Square	Curved	Recessed	Flush	Angled	Round
Surface Mounting	Y	Y	Y	Y	Y	Y
Recessed Mounting	N	N	Y	Y	N	N
U-Clip Mounting	Y	Y	Y	Y	N	Y
Magnet Mounting	Y	Y	N	N	N	N
Available Finishes	Satin Nickel, Black, Dark Cherry, Natural Soft Maple, Custom	Satin Nickel, Black, Dark Cherry, Natural Soft Maple, Custom	Satin Nickel, Black	Satin Nickel	Satin Nickel, Dark Cherry, Natural Soft Maple, Custom	Satin Nickel, Black
Available Diffusers	Clear, Frost, Milk	Clear, Frost, Milk	Clear, Frost, Milk	Milk	Clear, Frost, Milk	Clear, Frost, Milk

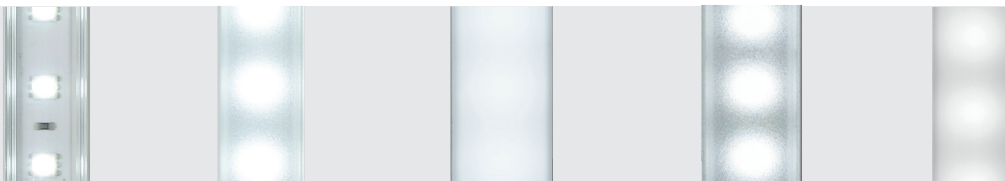

## FLEXTAPE® AND DIFFUSER OPTIONS AT A GLANCE

	1.5W FlexTape®	3W FlexTape®	4.4W FlexTape®	4.4W 12VDC COB FlexTape®	5.5W 24VDC COB FlexTape®	5.5W FlexTape®	1.5W EquiLine Tape	3W EquiLine Tape	4.4W EquiLine Tape
Lumens w/ Clear Infinex Diffuser	125	310	355	210	330	520	115	215	335
Lumens w/ Frosted Infinex Diffuser	115	285	325	195	305	480	105	200	310
Lumens w/ Milk Infinex Diffuser	95	235	270	160	255	395	85	165	255

## 2 CUT TO SIZE

Aluminum extrusions can be cut by various pieces of equipment. For the best performance and longest life, use a saw blade designed for non-ferrous, thin stock on your miter saw. It is also highly recommended to cut extrusion with diffuser securely attached via clamps, tape, stretch wrap etc. to prevent unwanted cracking of diffuser.

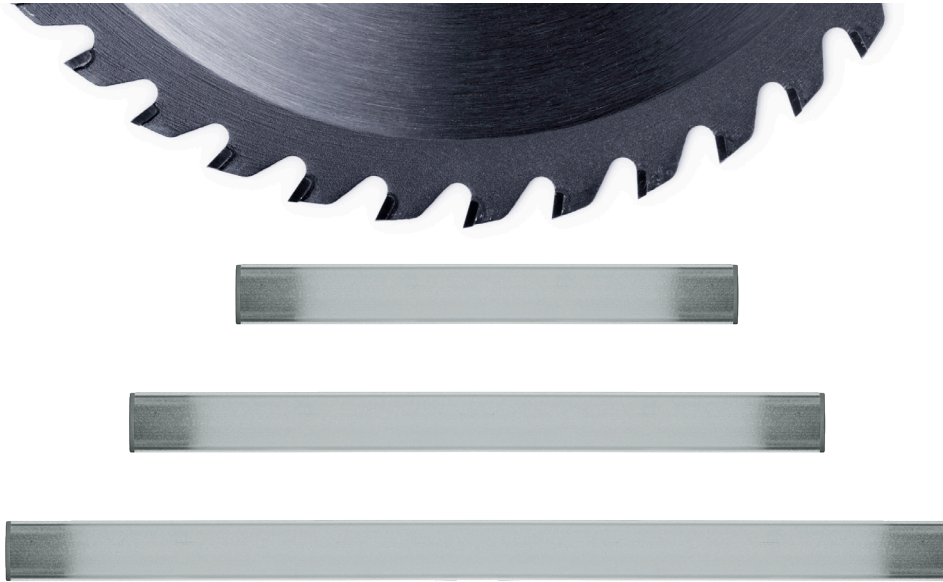

## 3 ASSEMBLE

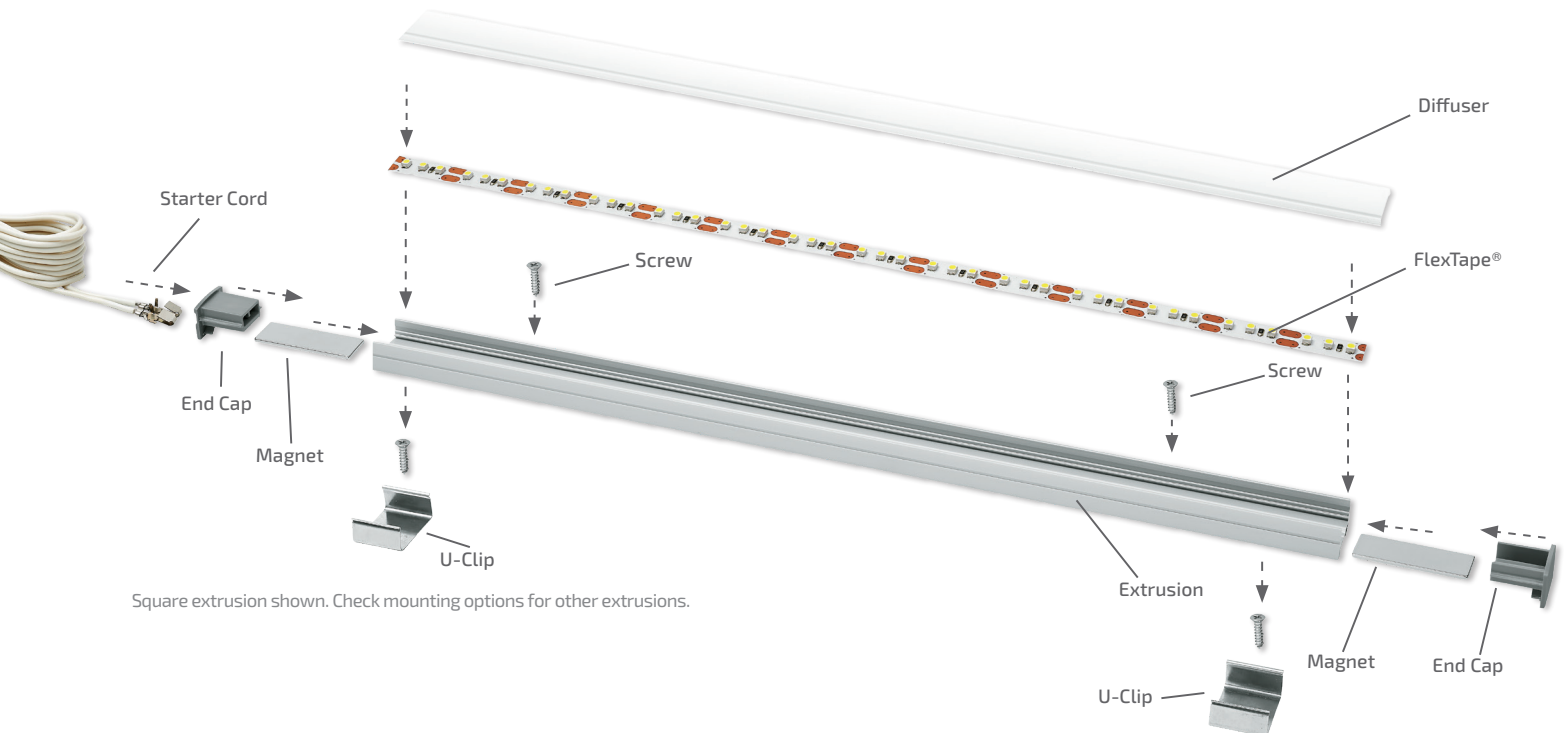

Square extrusion shown. Check mounting options for other extrusions.

## EXTRUSION STYLES AND FEATURES

### SQUARE



MOUNTING



U-Clips sold separately

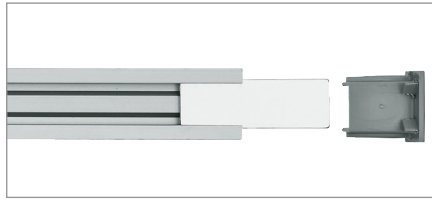

Couplers Sold Separately



Profile

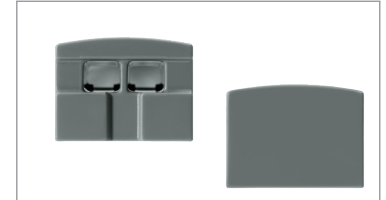
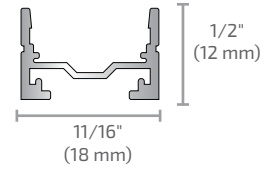

End Caps Sold Separately

#### Features

- Surface mount using magnets, U-Clips or screws
- Easily slide magnets into channel on bottom of light
- Uses Infinex starter leads

#### Available stock finishes



### CURVE



MOUNTING



U-Clips sold separately

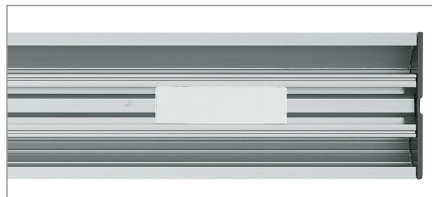

Couplers Sold Separately

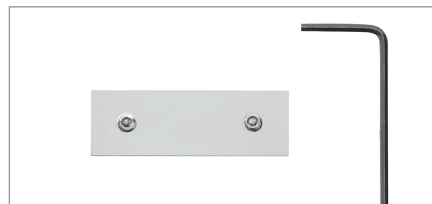

Profile

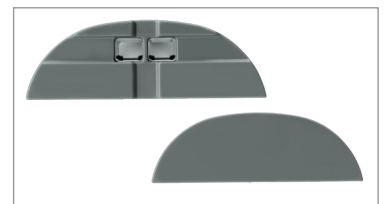
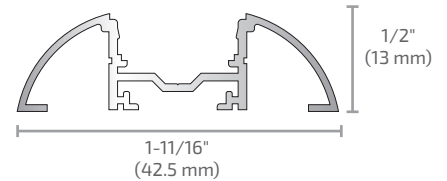

End Caps Sold Separately

#### Features

- Surface mount using magnets, U-Clips or screws
- Easily slide magnets into channel on bottom of light
- Uses Infinex starter leads

#### Available stock finishes





**ANGLE**

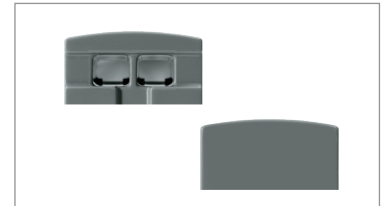
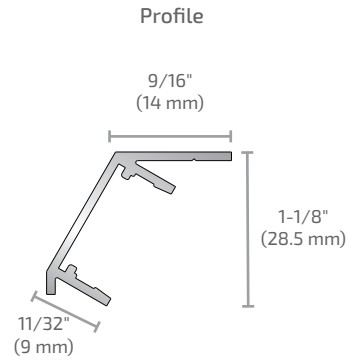
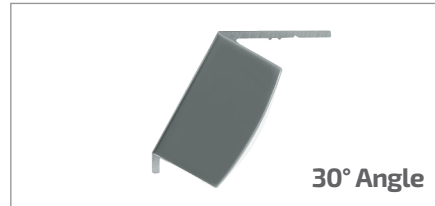

End Caps Sold Separately

**Features**

For corner mounting with screws only

Fixture directs light at 30° angle

Uses Infinex starter leads

**Available stock finishes**



**ROUND**



U-Clips sold separately

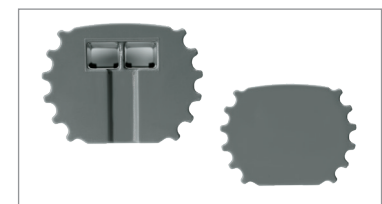
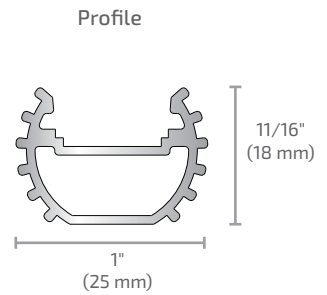
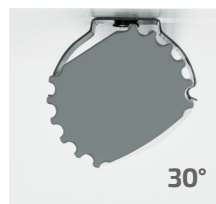

End Caps Sold Separately

**Features**

U-Clip mounting allows fixture to be rotated in 15° increments either direction (30°, 15°, 0°, -15°, -30°)

Uses Infinex starter leads

**Available finishes**

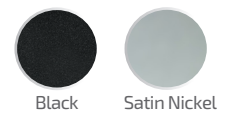

## RECESSED

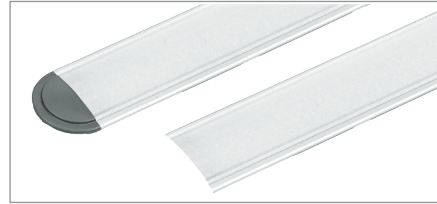
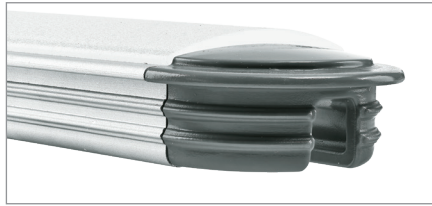

Profile

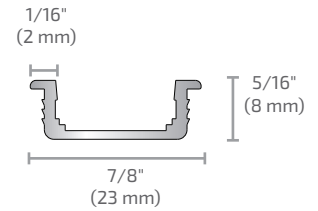

End Caps Sold Separately

### Features

Grooved sides allow extrusion to pressure fit into place\*

Uses standard FlexTape® starter lead

\*With Endcap: Rout a channel in wood 21/64" (8.33 mm) depth minimum x .750" (19 mm) width and pressure fit this extrusion in place.

Without Endcap: Rout a channel in wood 9/32" (7.14 mm) depth minimum x .750" (19 mm) width and pressure fit this extrusion in place.

Recessed extrusion uses standard FlexTape® starter lead. (L-LED-TPEPKT-2M-1, L-24B2SPKT-2M-1)

Use square mounting clips to surface mount recessed style extrusion.

Recessed End Cap Dimensions:

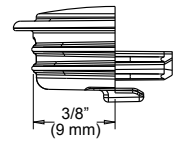
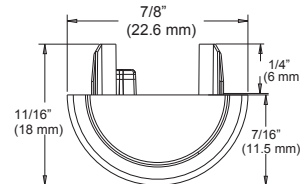
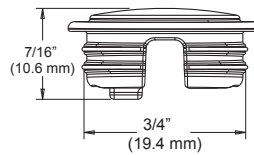

### Available finishes



## FLUSH



Profile

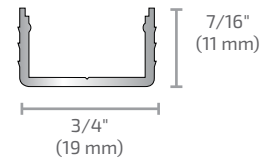

No End Caps

### Features

No end caps...this extrusion is meant for channels that go the entire width or height of the casework

Comes with milk diffuser (unattached)

Uses standard FlexTape® starter lead

\*Rout a channel in wood 7/16" (11 mm) depth x 3/4" (19 mm) width and pressure fit this extrusion in place.

Flush extrusion uses standard FlexTape® starter lead. (L-LED-TPEPKT-2M-1, L-24B2SPKT-2M-1)

### Available finishes

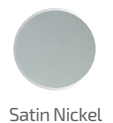

- Required
- Optional

## Extrusions

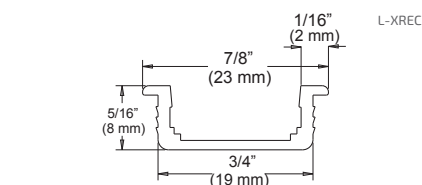
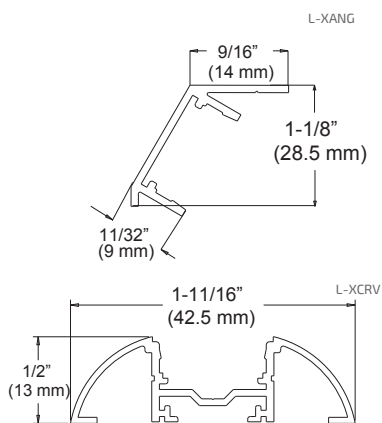

Part #	Description
L-XANG72-SC-1	72" (1.8 m) Angled Extrusion, Satin Clear
L-XANG72-**-1	72" (1.8 m) Angled Extrusion, Other Finishes
L-XCRV72-SC-1	72" (1.8 m) Curved Extrusion, Satin Clear
L-XCRV72-**-1	72" (1.8 m) Curved Extrusion, Other Finishes
L-XREC72-SC-1	72" (1.8 m) Recessed Extrusion, Satin Clear
L-XREC94-SC-1	94" (2.4 m) Recessed Extrusion, Satin Clear
L-XREC72-BL-1	72" (1.8 m) Recessed Extrusion, Black
L-XREC94-BL-1	94" (2.4 m) Recessed Extrusion, Black
L-XRND72-SC-1	72" (1.8 m) Round Extrusion, Satin Clear
L-XRND72-BL-1	72" (1.8 m) Round Extrusion, Black
L-XSQR72-SC-1	72" (1.8 m) Square Extrusion, Satin Clear
L-XSQR72-**-1	72" (1.8 m) Square Extrusion, Other Finishes
L-XFL72-SC-1	72" (1.8 m) Flush Extrusion, Satin Clear with Milk Diffuser
L-XFL94-SC-1	94" (2.4 m) Flush Extrusion, Satin Clear with Milk Diffuser

\*\*Insert BL for Black, DC for Dark Cherry, NSM for Natural Soft Maple

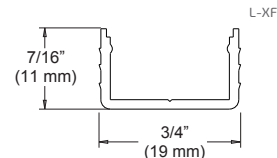
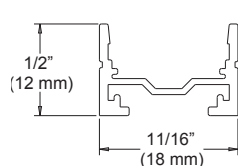
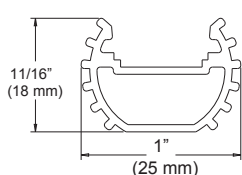

## Power Supplies



For details see Power Supplies on Page 150.

Infinex works with all Tresco® 12VDC and 24VDC power supplies.

## Diffusers

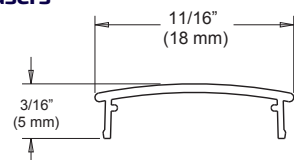

Part #	Description
L-X**-DIFF-CL-1	Diffuser, Clear
L-X**-DIFF-FR-1	Diffuser, Frosted
L-X**-DIFF-MLK-1	Diffuser, Milk

\*\*Insert 72 for 72" (1.8 m) length, or 94 for 94" (2.4 m) length

## End Cap Sets

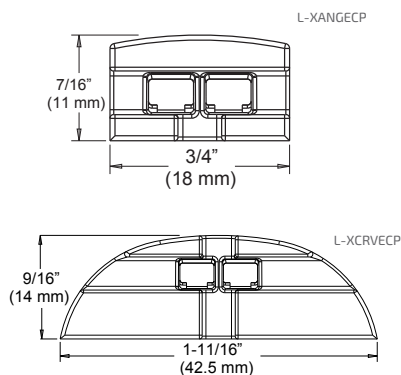

Part #	Description
L-XANGECP-GY-1	Angled end cap set, Gray
L-XANGECP-**-1	Angled end cap set, Other Colors
L-XCRVECP-GY-1	Curved end cap set, Gray
L-XCRVECP-**-1	Curved end cap set, Other Colors
L-XRECECP-GY-1	Recessed end cap set, Gray
L-XRECECP-BL-1	Recessed end cap set, Black
L-XRNDCECP-GY-1	Round end cap set, Gray
L-XRNDCECP-BL-1	Round end cap set, Black
L-XSQRECP-GY-1	Square end cap set, Gray
L-XSQRECP-**-1	Square end cap set, Other Colors

\*\*Insert BL for Black, B1 for Dark Brown, B2 for Tan  
Flush extrusion does not take end caps. End caps cannot be used with link cords.

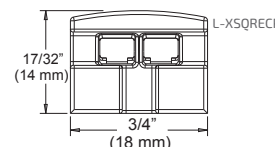
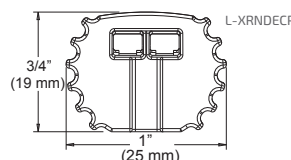
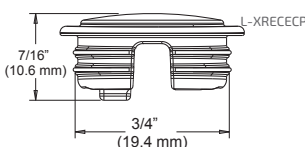



● 12/24VDC Infinex Starter Cords

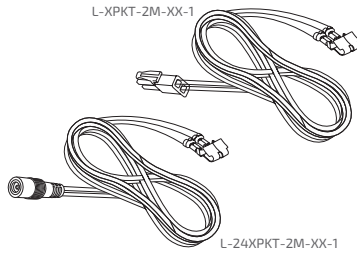

Part #	Description
L-XPKT-2M-BL-1	79" (2 m) 12VDC Infinex Starter Cord, Black
L-XPKT-2IN-BL-1	2" (50 mm) 12VDC Infinex Starter Cord, Black
L-XPKT-2M-WH-1	79" (2 m) 12VDC Infinex Starter Cord, White
L-XPKT-2IN-WH-1	2" (50 mm) 12VDC Infinex Starter Cord, White
L-24XPKT-2M-BL-1	79" (2 m) 24VDC Infinex Starter Cord, Black
L-24XPKT-2M-WH-1	2" (50 mm) 24VDC Infinex Starter Cord, White

To be used with square, curved, round and angled extrusions only.

● 12/24VDC Standard FlexTape® Starter Cords

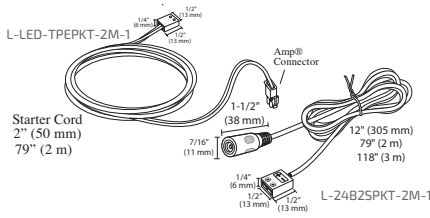

Part #	Description
L-TPEPKT-2IN-1	2" (50 mm) 12VDC FlexTape® Straight Starter Lead
L-LED-TPEPKT-2M-1	79" (2 m) 12VDC FlexTape® Straight Starter Lead
L-24B2SPKT-305MM-1	305 mm (12") 24VDC FlexTape® Barrel/2 Screw Trml Starter Lead, White
L-24B2SPKT-2M-1	2 m (79") 24VDC FlexTape® Barrel/2 Screw Trml Starter Lead, White
L-24B2SPKT-3M-1	3 m (118") 24VDC FlexTape® Barrel/2 Screw Trml Starter Lead, White

Recessed and Flush extrusions use standard FlexTape® starter lead.

● U-Clips/Magnets

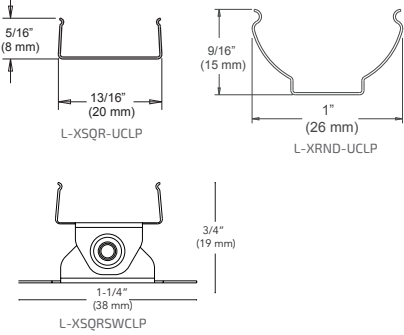

Part #	Description
L-XRND-UCLP-1	Round U-Clips Set (2 Clips)
L-XSQR-UCLP-1	Square/Curved U-Clips Set (2 Clips)
L-XSQRSWCLP-1	Square/Curved Swivel Clips Set (2 Clips)
L-XRM42-155-1	Set of 2 Magnets
L-EXTMP-VHB-1	Set of 2 Mounting Plates

One U-Clip/magnet is recommended for every 1 ft. (.3 m) of extrusion. No. #4 Phillips flat head screws are included with each U-Clip set. Mounting Plates to be used with magnet mounted Infinex.

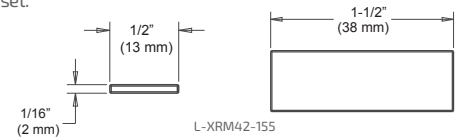

● Couplers

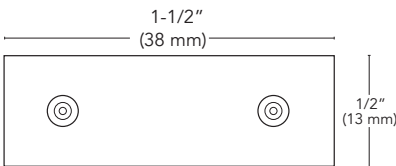

Part #	Description
L-EXTBTB10-1	Pack of 10 Couplers

To be used on square and curved extrusions only.

● 12/24VDC Linking Cords

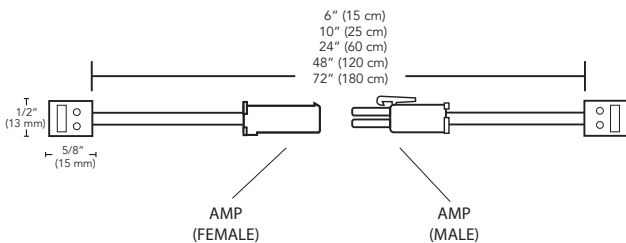

Part #	Description
L-XLNK-15-**-1	6" (15 cm) Infinex Linking Cord
L-XLNK-25-**-1	10" (25 cm) Infinex Linking Cord
L-XLNK-60-**-1	24" (60 cm) Infinex Linking Cord
L-XLNK-120-**-1	48" (120 cm) Infinex Linking Cord
L-XLNK-180-**-1	72" (180 cm) Infinex Linking Cord

\*\* Insert BL for Black and WH for White

End Caps not used on linked extrusion ends.



COMPONENTS: POWER SUPPLIES, CONTROLLERS AND MORE SEE PAGE 150.









12VDC

24VDC

120V

# COMPONENTS

Power Supplies  
Controllers  
Install Accessories





# Power Supplies

**30W 12VDC**  
100V - 277V



**60W 12VDC**  
100V - 277V

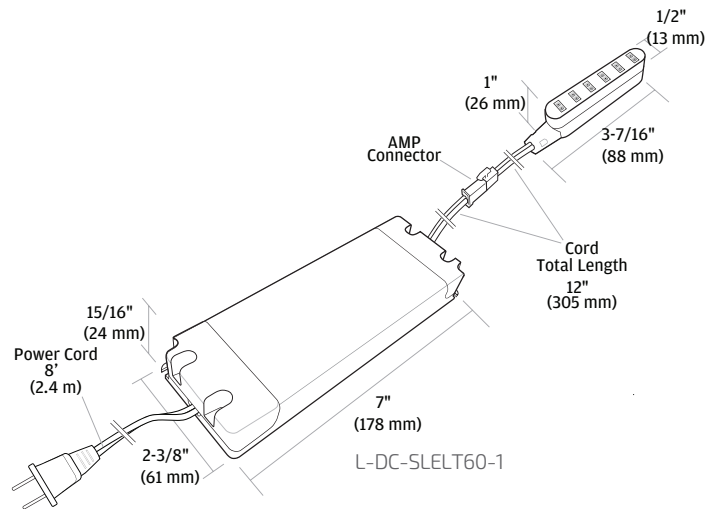
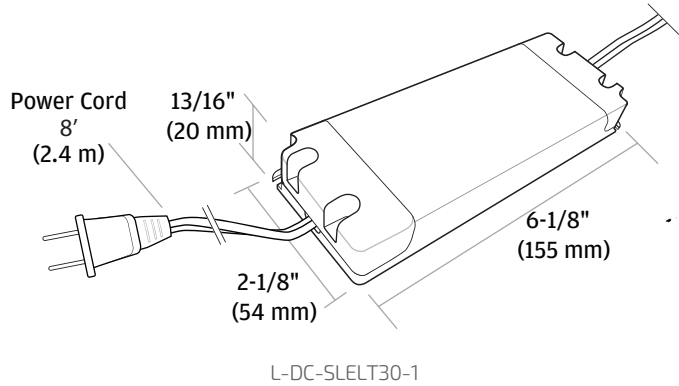

**Features:**

- Slim design, under 1" height
- (2) configurations: 30W or 60W
- 12VDC constant voltage output
- High power factor (Pf > .95)
- Short circuit protection\*
- Overcurrent protection
- Overload protection\*
- RFI protection
- Dimmable on trailing edge (12VDC side)
- Class 2

✓ Compatible with all Tresco low voltage dimmers  
 ✗ NOT compatible with hardwire wall dimmers

Part #	Description
L-DC-SLELT30-1	30W 12VDC Power Supply w/6 Snap Mounting Block
L-DC-SLELT60-1	60W 12VDC Power Supply w/6 Snap Mounting Block
L-TRANS-MNT-BL-1	Extra 6-Snap Mounting Block

Economy Series

# 12VDC EquiLine Plug-in Power Supplies

**6W 12VDC**  
100V - 240V



L-DC-ELT6WP-CON-1

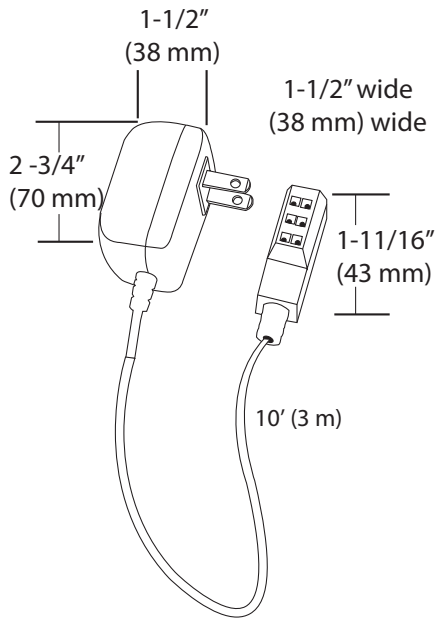

**30W 12VDC**  
100V - 277V

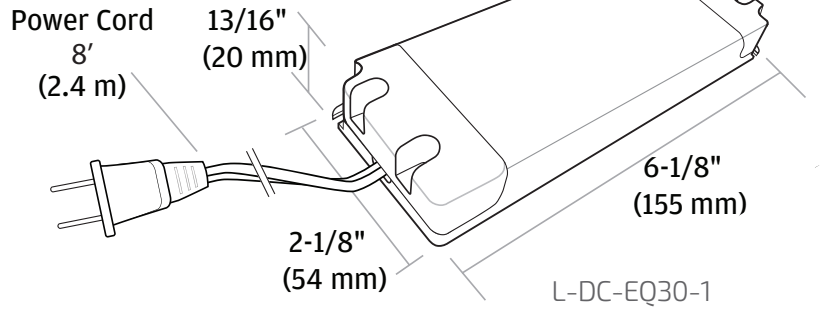

✓ Compatible with all Tresco® low voltage dimmers  
 ✗ NOT compatible with hardwire wall dimmers

Part #	Description
L-DC-ELT6WP-CON-1	6W 12VDC Wall Mount Power Supply w/3 Snap Block
L-DC-EQ30-1	30W 12VDC EquiLine Power Supply w/6 Snap Block
L-TRANS-MNT-BL-1	Extra 6-Snap Mounting Block

**Features:**

- (2) Configurations: 6-30 Watt
- 12VDC constant voltage output
- Short circuit protection\*
- Overload protection\*
- RFI Protection
- Dimmable on trailing edge (12VDC side)
- Class 2

2-Year warranty

\*Automatic Reset (no fuses)

\* Automatic reset (no fuses)

**Economy Series**  
**12VDC EquiLine Plug-in Power Supplies**

**15W 12VDC**  
 100V - 240V



L-DC-ELT15WP-CON-1

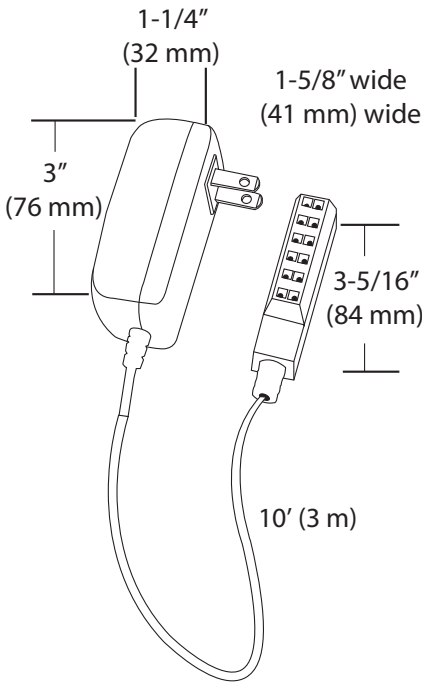

**60W 12VDC**  
 100V - 277V

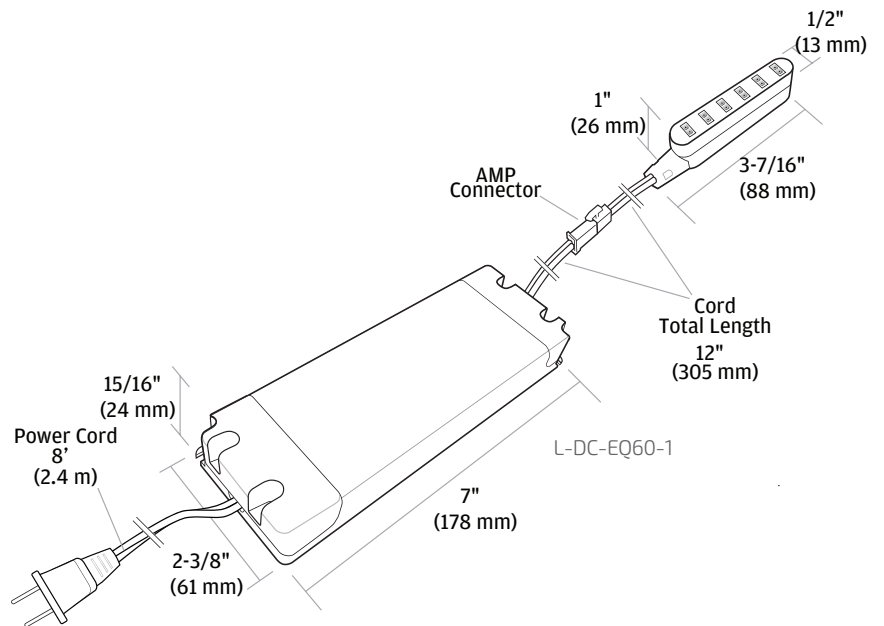

✓ Compatible with all Tresco® low voltage dimmers  
 ✗ NOT compatible with hardwire wall dimmers

Part #	Description
L-DC-ELT15WP-CON-1	15W 12VDC Wall Mount Power Supply w/6 Snap Block
L-DC-EQ60-1	60W 12VDC EquiLine Power Supply w/6 Snap Block
L-TRANS-MNT-BL-1	Extra 6-Snap Mounting Block

**Features:**

- (2) Configurations: 15-60 Watt
- 12VDC constant voltage output
- Short circuit protection\*
- Overload protection\*
- RFI Protection
- Dimmable on trailing edge (12VDC side)
- Class 2
- 2-Year warranty

\*Automatic Reset (no fuses)



# 12VDC Commercial Wall Dimmable Hardwire Power Supplies

**30W 12VDC**  
100V - 277V



**60W 12VDC**  
100V - 277V



**Features:**

- Under 1" height
- (2) configurations: 30W or 60W
- 12VDC constant voltage output
- High power factor (Pf > .95)
- Dimmable by standard LED wall dimmers
- Continuous smooth dimming
- Wire directly into unit
- Electronic units are lower profile and generate less heat than magnetic transformers
- Quiet operation
- Works with all Tresco® 12VDC dimmable LED fixtures
- One 6-snap mounting block included
- RFI Protection
- Class 2 with short circuit and automatic reset

NOT COMPATIBLE WITH CONTROL 4

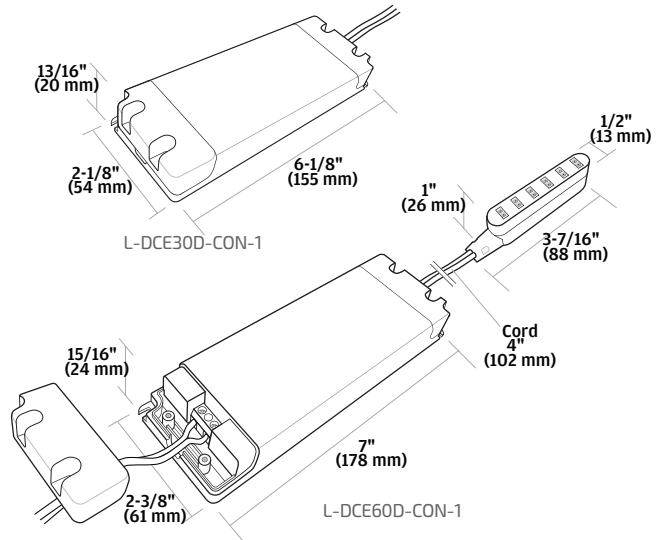

- ✓ Compatible with all Tresco® low voltage dimmers
- ✓ Compatible with hardwired LED wall dimmers



Part #	Description
L-DCE30D-CON-1	30W 12VDC Hardwire Dimmable LED Power Supply
L-DCE60D-CON-1	60W 12VDC Hardwire Dimmable LED Power Supply
L-TRANS-MNT-BL-1	Extra 6-Snap Mounting Block

**Compatible Tresco Wall Dimmers (page 158).**



Dimmable by LED compatible line voltage (120V) wall dimmers. Mounting block included. Requires electrician to install.

# 12VDC Industrial Wall Dimmable Hardwire Power Supplies

(1x 60W output)

**60W 12VDC**  
100V - 277V



(3x 60W output)

**180W 12VDC**  
100V - 277V

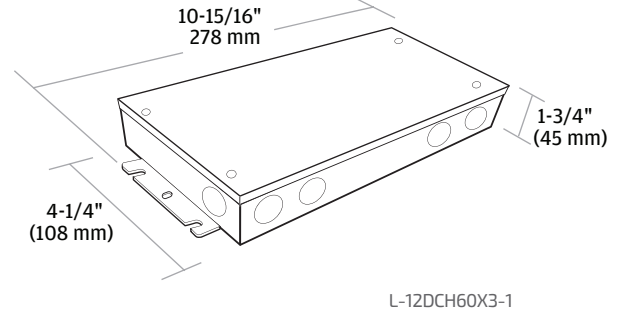
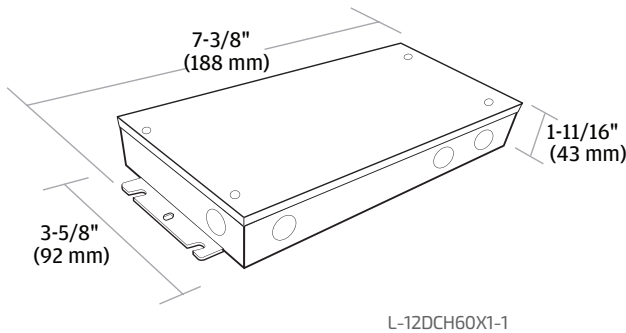

**Features:**

- Slim design, under 2" height
- (2) configurations: 60W or 180W
- 12VDC constant voltage output
- High power factor (Pf > .95)
- Built-in hardwire compartment
- All metal construction
- Short circuit protection\*
- Overcurrent protection
- Overload protection\*
- RFI protection
- Dimmable by standard LED wall dimmers
- Class 2

- ✓ Compatible with all Tresco® low voltage dimmers
- ✓ Compatible with hardwired LED wall dimmers

Part #	Description
L-12DCH60X1-1*	60W 12VDC Commercial/Industrial Metal Hardwire Dimmable Power Supply
L-12DCH60X3-1*	180W 12VDC Commercial/Industrial Metal Hardwire Dimmable Power Supply
L-12DCH60X5-120-277V-1	300W 12VDC Commercial Hardwire 0-10V Dimmable Power Supply
L-TRANS-MNT-BL-1	Extra 6-Snap Mounting Block

\* Does not include 6-snap mounting block  
Dimmable by LED line voltage (120V) wall dimmers. Mounting block not included  
Requires electrician to install.

\* Automatic reset (no fuses)

**Compatible Tresco Wall Dimmers (page 158).**



# 24VDC Commercial Plug-in Power Supplies

**48W 24VDC**  
100V - 240V

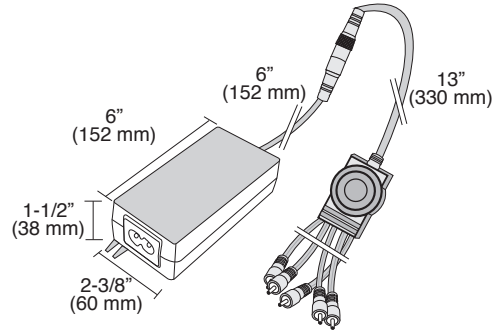

L-24DCELT48-BL-1

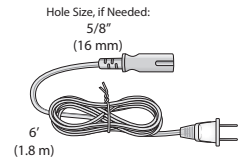

- ✓ Compatible with all Tresco low voltage dimmers
- ✗ NOT compatible with hardwire wall dimmers

**96W 24VDC**  
100V - 240V

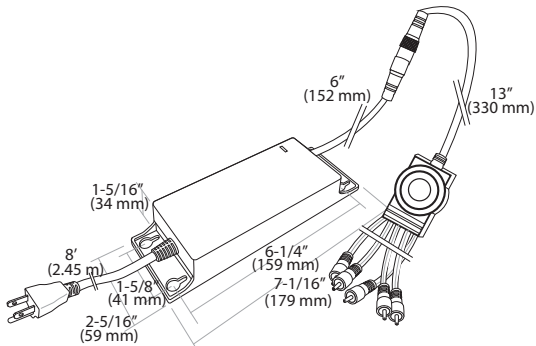

L-24DCELT96-1

**Features:**

- Slim design, under 1.6" height
- 24VDC constant voltage output
- High power factor (Pf > .95) **96W only**
- (5) barrel output (included)
- Short circuit protection\*
- Overcurrent protection
- Overload protection\*
- RFI protection
- Dimmable on trailing edge (24VDC side)
- Class 2

\* Automatic reset (no fuses)

Part #	Description
L-24DCELT48-BL-1	48W 24VDC Power Supply w/ 5 Barrel Out, Black
L-24DCELT96-1	96W 24VDC Power Supply w/ 5 Barrel Out, White
L-1BRL5-1	Extra 5 Output Barrel Splice





Economy Series

## 24VDC EquiLine Plug-in Power Supply

15W 24VDC  
100V - 240V

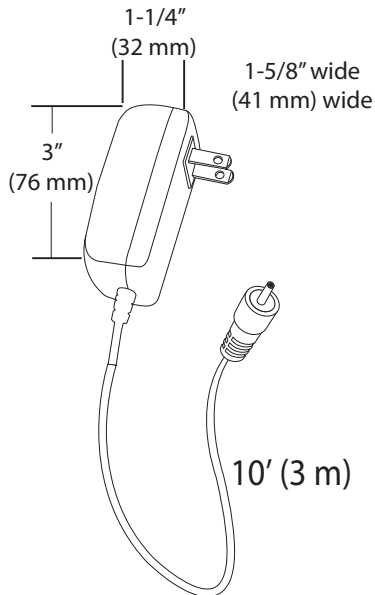

### Features:

- 24VDC constant voltage output
- Fully enclosed wall mount plastic case
- Single barrel connector output
- Short circuit protection\*
- Overcurrent protection
- Overload protection\*
- RFI protection
- Dimmable on trailing edge (24VDC side)
- Class 2
- 2-Year warranty

\*Automatic Reset (no fuses)

- ✓ Compatible with all Tresco low voltage dimmers
- ✗ NOT compatible with hardwire wall dimmers



Part #	Description
L-24DCELT15WP-1	15W 24VDC Wall Mount Power Supply w/ Barrel Connector
L-1BRL5-1	Extra 5 Output Barrel Splice

# 24VDC Industrial Wall Dimmable Hardwire Power Supplies

(1x 96W output)

**96W 24VDC**  
100V - 277V



(3x 96W output)

**288W 24VDC**  
100V - 277V

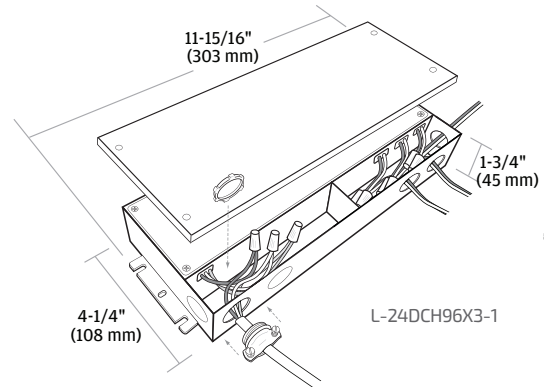
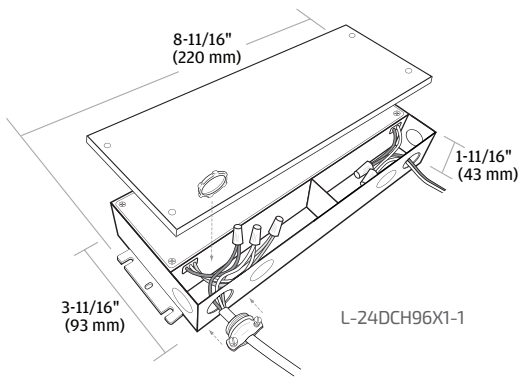

**Features:**

- Slim design, under 2" height
- 24VDC constant voltage output
- High power factor (Pf>.95)
- Built-in hardwire compartment
- All metal construction
- Short circuit protection\*
- Overcurrent protection
- Overload protection\*
- RFI protection
- Dimmable by standard LED wall dimmers
- Class 2

\* Automatic reset (no fuses)

Part #	Description
L-24DCH96X1-1*	24VDC 96W Commercial/Industrial Metal Hardwire Dimmable Power Supply
L-24DCH96X3-1*	24VDC 288W Commercial/Industrial Metal Hardwire Dimmable Power Supply
L-24DCH96X4-120-277V-1	384W 24VDC Commercial Hardwire 0-10V Dimmable Power Supply
L-1BRLS-1	Extra 5 Output Barrel Splice

\*Does not include 5 Output Barrel.  
Dimmable by LED line voltage (120V) wall dimmers.  
Mounting block not included

Requires electrician to install.

- ✓ Compatible with all Tresco® low voltage dimmers
- ✓ Compatible with hardwired LED wall dimmers

**Compatible Tresco Wall Dimmers (page 158).**



# 120V Wi-Fi Enabled LED Wall Controllers

120V

Compatible with Tresco 12VDC and 24VDC Wall Dimmable Power Supplies (previous pages)



## Swidget Bundles



### Swidget Standard Switch w/ Wi-Fi Control Insert

Single pole and 3-way wiring compatible for lighting and fan applications

Direct power monitoring and capability for scene programming with the Swidget App

Neutral wire required for installation

300W LED/CFL load rating

Indoor use only

5-Year Limited Warranty (Standard Switch)

2-Year Limited Warranty (Wi-Fi Control Insert)

For plug-in power supplies, wirelessly connect a Swidget 20A Outlet and Standard Switch using the Swidget App.



### Swidget 20A Outlet w/ Wi-Fi Control Insert

Independent power monitoring for each of the (2) receptacles

Tamper resistant shutters for safe operation

Neutral wire required for installation

Wirelessly control the bottom receptacle with the Swidget App

Installs like a standard wall receptacle using the same wiring

Indoor use only

5- Year Limited Warranty (20A Outlet)

2-Year Limited Warranty (Wi-Fi Control Insert)



### Swidget Dimmer Switch w/ Wi-Fi Control Insert

Designed with industry-leading anti-flicker technology for dimmable LEDs

Direct power monitoring

Unique ON/OFF/Dimmer wireless control in a single pad with the capability for scene programming

Neutral wire required for installation

150W LED/CFL load rating

Compatible with all Tresco® dimmable power supplies

Indoor use only

5-Year Limited Warranty (Dimmer Switch)

2-Year Limited Warranty (Wi-Fi Control Insert)

#### Part #

#### Description

L-S16001WI000-1	120VAC 300W/600W Swidget Toggle Switch w/ Wi-Fi Control Insert, White
L-R1020WI000-1	120VAC 20A Swidget Outlet w/ Wi-Fi Control Insert, White
L-SD300WI000-1	120VAC 150W/300W Swidget Dimmer Switch w/ Wi-Fi Control Insert, White

Electrician required for install. Works with all standard Rocker Switch plates (not included).  
See page 182 for more details





# 120V LED Wall Controllers

120V

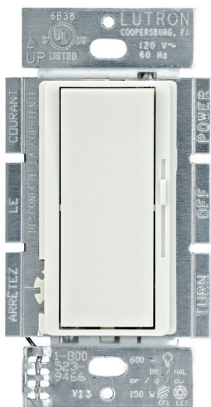

150W

## Lutron Diva® C-L™ Dimmer 150W

Large paddle switch with a captive linear-slide dimmer for a standard designer wall plate opening

Switch returns light to preset light level

Offers more reliable dimming performance over standard dimmers

HED™ technology with advanced dimming circuitry designed for compatibility with most high-efficiency light bulbs

Adjustment switch to modify the minimum light level in order to maximize the dimming range if flickering occurs at lower dimming levels



150W

## Lutron Skylark Contour C-L™ Dimmer 150W

On/off rocker switch with a captive linear-slide dimmer for a standard designer wallplate opening

Switch returns light to preset light level

Offers more reliable dimming performance over standard dimmers

HED™ technology with advanced dimming circuitry designed for compatibility with most high-efficiency light bulbs

Low-end adjustment dial



300W

## Leviton Decora® 300W

Large paddle switch with a captive linear-slide dimmer for a standard designer wall plate opening

Packaged with White, Ivory, and Light Almond color change kits

Switch returns light to preset light level

No neutral wire required for installation

Adjustment switch to modify the minimum light level in order to maximize the dimming range if flickering occurs at lower dimming levels

Part #	Description
L-DVCL-153P-WH-1	Lutron Diva® 150W C-L™ Dimmer w/out plate
L-CTCL-153P-WH-1	Lutron Skylark Contour C-L™ 150W Dimmer w/out plate
L-DSL06-1LZ-1	Leviton® Decora® 300W LED Dimmer w/WH-IV-LA Kit

# Controllers

Single color control

# FREEDiM

WIRELESS CONTROL



## FREEDiM Series Universal Receiver

12VDC  
24VDC

### Features:

60W Capacity (12VDC); 96W Capacity (24VDC)

Power failure memory

Multiple receivers can be used in a single power supply or within a room to achieve multiple zones of control

Simple one button pairing with dimmers

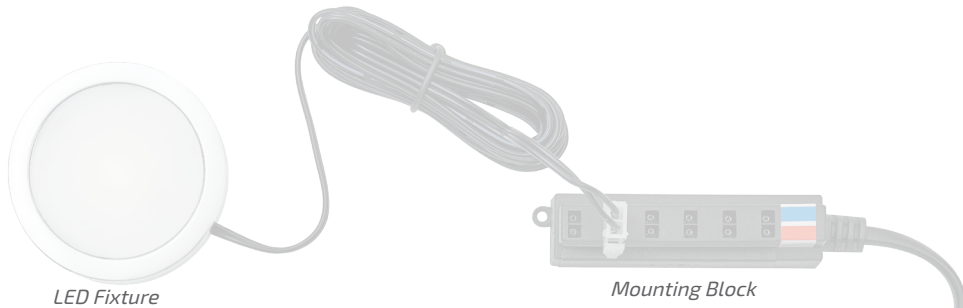

Compatible with all single color FREEDiM Series controllers

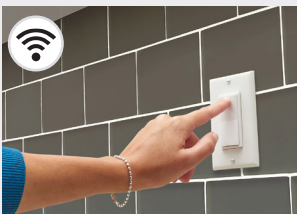

Deco Wall Dimmers



Micro Dimmers

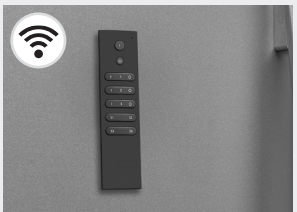

3 Zone Remote

## Universal FREEDiM Series Receiver L-WLD-1REC-1

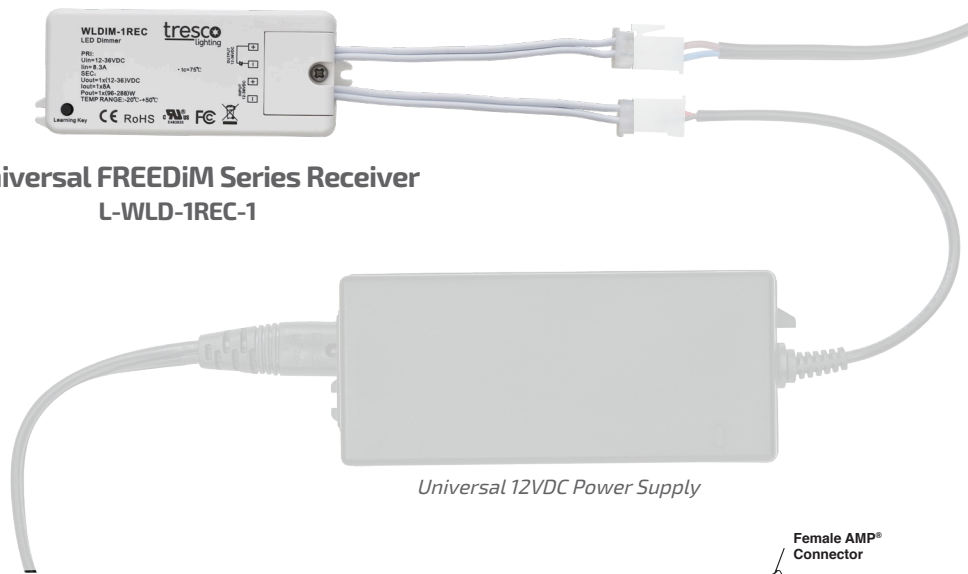

Universal 12VDC Power Supply

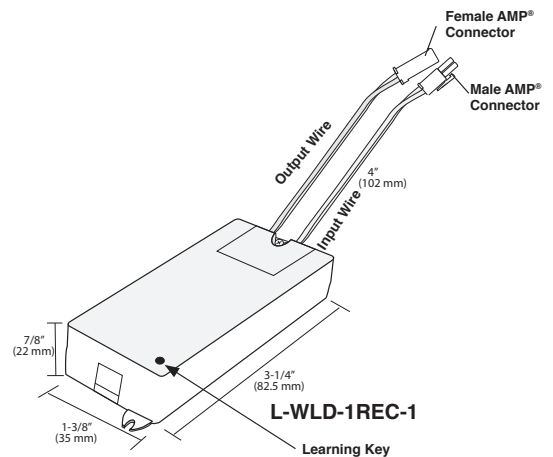

Part #	Description
L-WLD-1REC-1	12/24VDC FREEDiM Series Receiver

A single receiver can be programmed to up to 8 different FREEDiM Series remotes/dimmers

All product dimensions and specifications are subject to change without prior notice.

Single Color Controllers

**PATENT NO. 9,818,559 B2**

## FREEDiM Series Deco Wall Dimmer

### Features:

Available in single and 2-zone

Can be programmed to multiple receivers for more lighting control

Black, white, or light almond finish

Fits Decora® style wall plates

65 ft. (20 m) range of control from dimmer to receiver

Controls all Tresco® 12/24VDC dimmable low voltage lights

Unlike traditional hardwire dimmers, you can control the same set of lights from multiple Deco Wall Dimmers

# FREEDiM

WIRELESS CONTROL

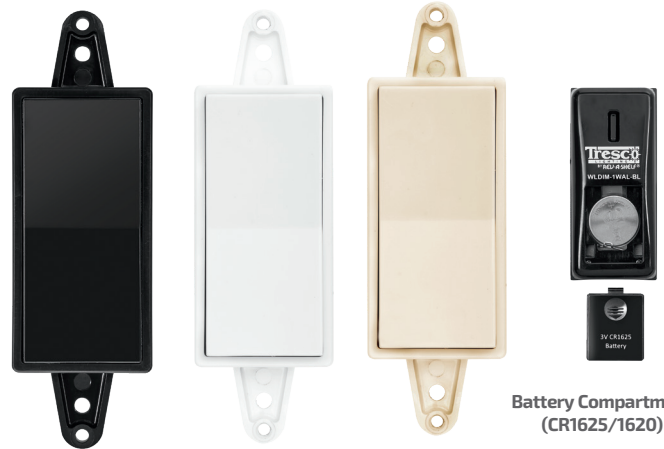

Battery Compartment (CR1625/1620)



Easily remove switch from docking tray to replace batteries or use as a remote dimmer

### Also available in 2-Zone:

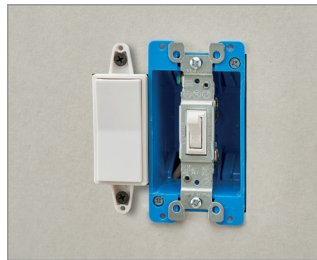

Can be mounted to standard wall electrical boxes or to drywall

Part #	Description
L-WLD-1WAL-**-1	FREEDiM Series Deco Wall Dimmer
L-WLD-2WAL-**-1	FREEDiM Series Two-Zone Deco Wall Dimmer
L-WLD-1REC-1	12/24VDC FREEDiM Series Receiver

\*\*Insert BL for Black (only available in single zone), WH for White, LA for Light Almond

**A single dimmer can be programmed to up to 10 different receivers. Must have at least one receiver (L-WLD-1REC-1) to operate**

**A single receiver can be programmed to up to 8 different FREEDiM Series remotes/dimmers**

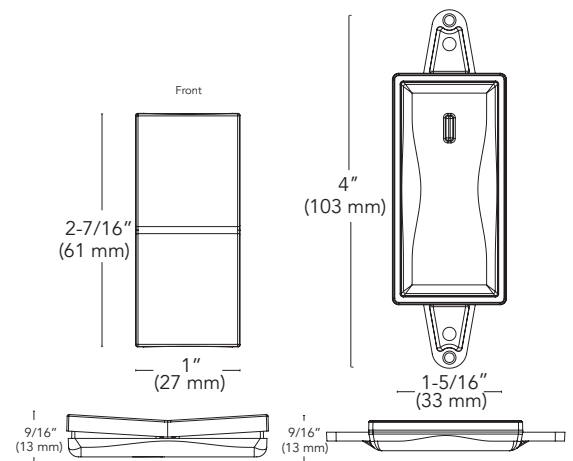

# FREEDiM Series Wireless Controllers



## FREEDiM Series Micro Dimmer

**Features:**

Single zone wireless dimmer

Black or Nickel finish

Easy to replace, long life lithium battery

65 ft. (20 m) range of control from dimmer to receiver

Controls all Tresco® 12/24VDC dimmable low voltage lights

Recess or surface mount

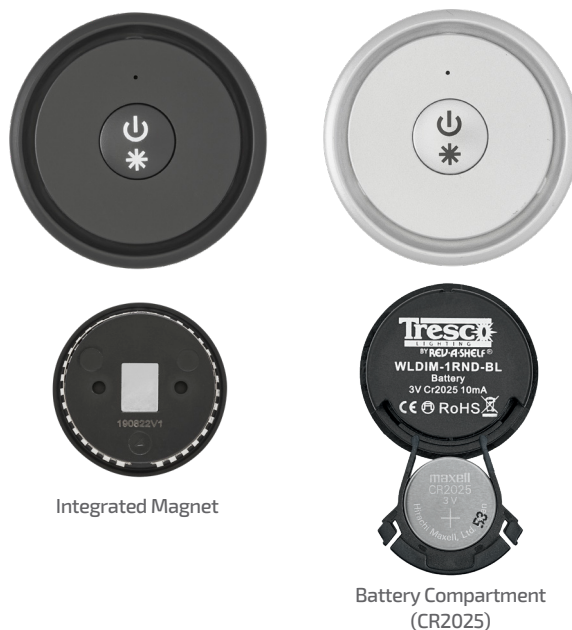

Integrated Magnet

Battery Compartment (CR2025)

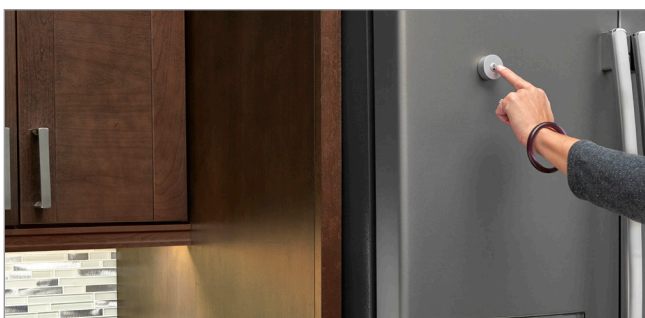

Integrated magnet allows for mounting to refrigerator or other metallic surfaces



Easy (2) screw installation

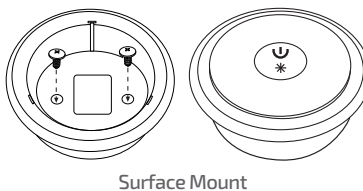
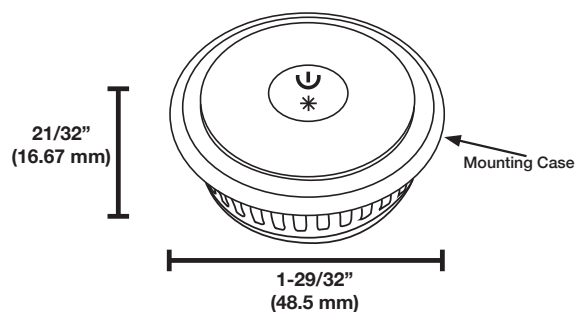

Surface Mount

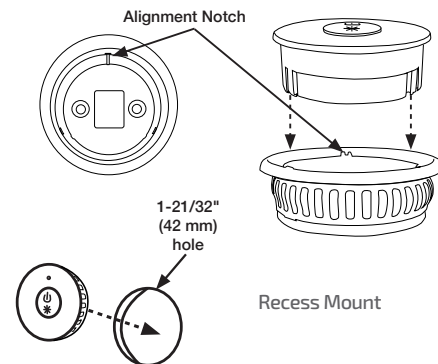

Recess Mount

Part #	Description
L-WLD-1RND-BL-1	FREEDiM Series Micro Dimmer, Black
L-WLD-1RND-NI-1	FREEDiM Series Micro Dimmer, Nickel
L-WLD-1REC-1	12/24VDC FREEDiM Series Receiver

A single dimmer can be programmed to up to 10 different receivers.  
**Must have at least one receiver (L-WLD-1REC-1) to operate**

A single receiver can be programmed to up to 8 different FREEDiM Series remotes/dimmers  
 Must purchase 12VDC to 24VDC Controller Adaptor Cord Set for 24VDC LED fixtures.



## FREEDiM Series 3 Zone Remote

### Features:

Independent control of 3 lighting zones from single remote

Program additional receivers to separate the lighting in a room into multiple zones that you can control independently

Set brightness levels of all of the zones to a desired level then save as a "scene"

65 ft. (20 m) range of control from remote to receiver

Controls all Tresco® 12/24VDC dimmable low voltage lights



Integrated magnet allows for mounting to refrigerator or other metallic surfaces



Docking tray can be screw mounted (Remotes attach to tray magnetically)

**FREEDiM**  
WIRELESS CONTROL



3-Zone  
(CR2032 Battery)



Battery Compartment  
(CR2032 Battery)

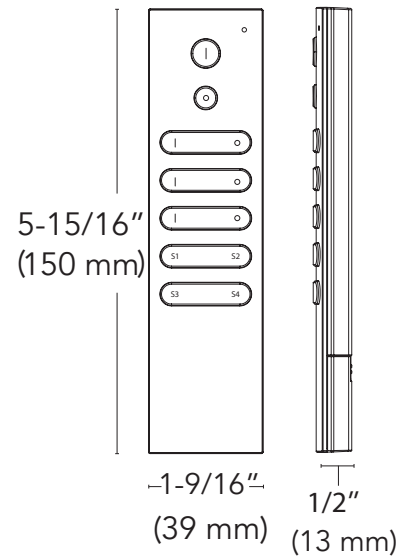

Part #	Description
L-WLD-3RMT-BL-1	FREEDiM Series 3-Zone remote, Black
L-WLD-1REC-1	12/24VDC FREEDiM Series Receiver

### Must have at least one receiver (L-WLD-1REC-1) to operate

A single receiver can be programmed to up to 8 different FREEDiM Series remotes/dimmers

# Wireless Door Sensor Receiver

12VDC  
24VDC



**Features:**

- 60W capacity (12VDC); 96W capacity (24VDC)
- Power failure memory
- Install inline between power supply and lights
- Simple one button pairing with Wireless Door Sensors
- Single receiver can be programmed with up to (4) sensors  
(Allows for up to 4 doors to control the same light fixtures.)

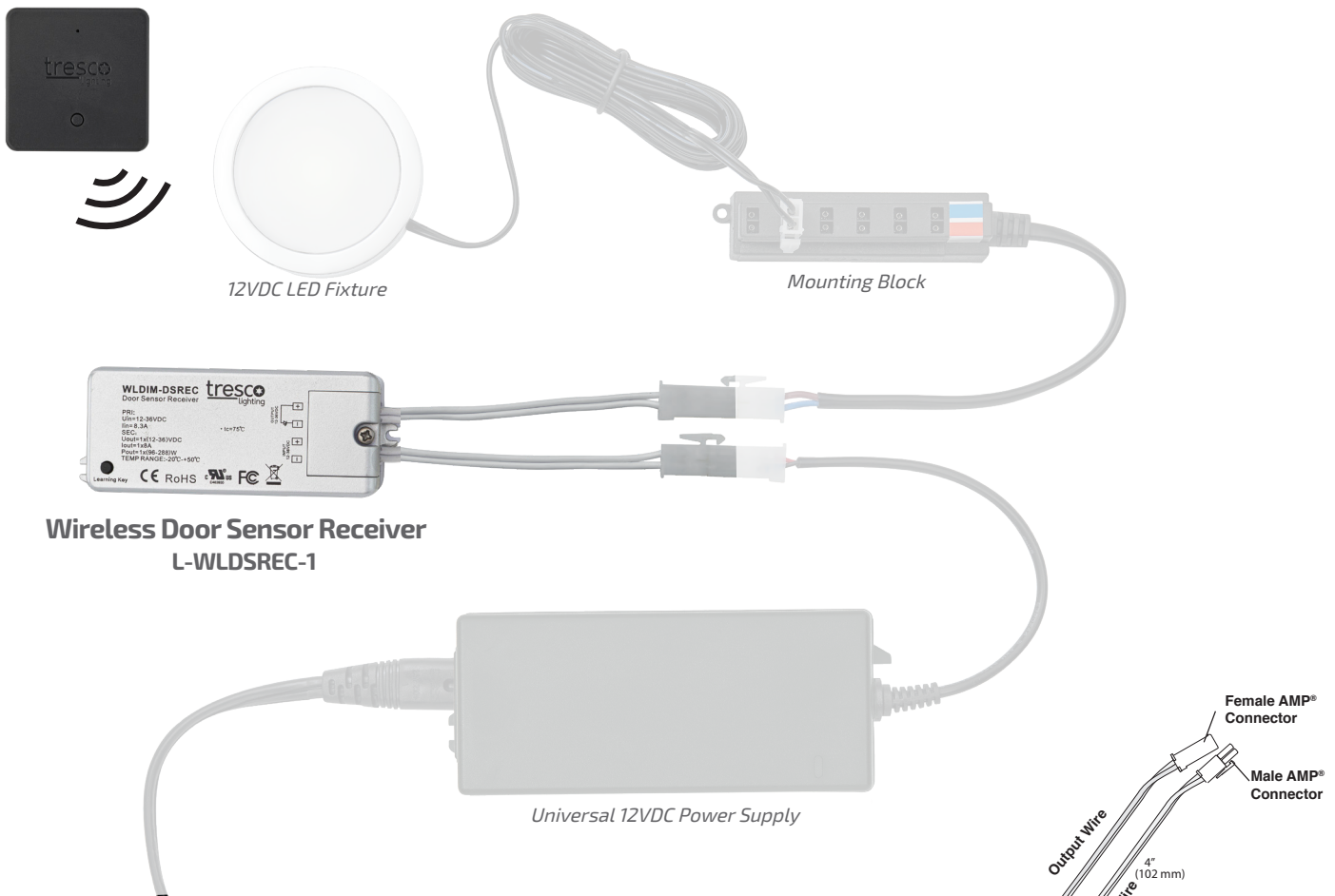

**Wireless Door Sensor Receiver**  
L-WLDSREC-1

Universal 12VDC Power Supply

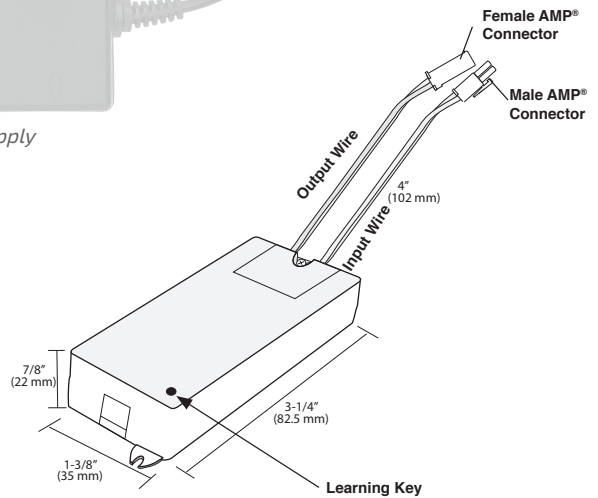

Part #	Description
L-WLDSREC-1	12/24VDC Wireless Door Sensor Receiver

Single receiver can be programmed with up to 4 door sensors.

# Wireless Door Sensor

**Features:**

- Allows light to be controlled by multiple doors
- Black or Nickel
- Simple push-button pairing with receiver (sold separately)
- Program up to (4) sensors to a single L-WLDSREC-1 receiver
- No cumbersome, messy wires to have to hide inside your cabinetry
- Mounting hardware (included)



Activated by a magnet; simply adhere to the inside of cabinet door with included double-stick adhesive



Comes with (3) stick-on magnet covers in black, brown and white

Part #	Description
L-WLDS-BL-1	FREEDiM Black Wireless Door Sensor
L-WLDS-NI-1	FREEDiM Nickel Wireless Door Sensor

**Must have at least one receiver (L-WLDSREC-1) to operate**

# FREEDiM

WIRELESS CONTROL



Long-lasting CR2025 battery

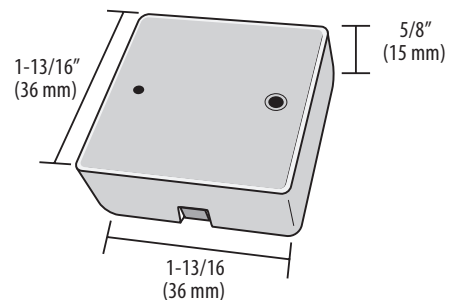
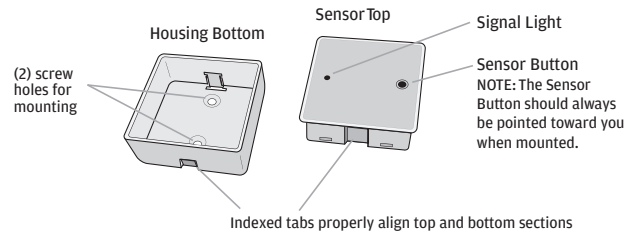

Economy Series

# EquiLine Receiver

12VDC  
24VDC

**FREEDiM**  
WIRELESS CONTROL

**Features:**

- 60W capacity (12VDC); 96W capacity (24VDC)
- Install inline between power supply and lights
- Power failure memory (retains last dim setting)
- 5" (127 mm) input and output cord attached
- Compatible with EquiLine FREEDiM Series Wireless Dimmer and Wireless Dimmer with Motion
- Simple one button pairing with EquiLine FREEDiM Series dimmers
- One receiver per dimmer required, receiver cannot be programmed to multiple dimmers
- 2-year warranty

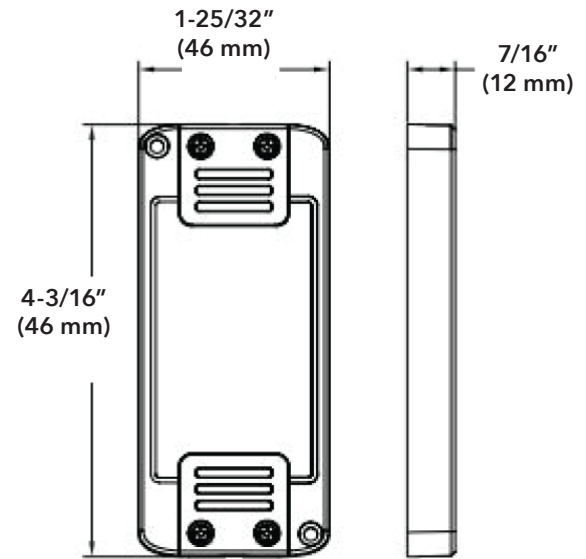

EquiLine Wireless Dimmer  
L-EQW-1DIM-BL-1



12VDC LED Fixture



Mounting Block



EquiLine Receiver  
L-EQW-1REC-1



Universal 12VDC Power Supply



Economy Series

## EquiLine Wireless Dimmers

### Features:

- Available in a motion sensor + dimmer or dimmer only
- Black or nickel finish
- Controls all Tresco® 12/24VDC single color dimmable low voltage lights
- Easy to replace, long life lithium CR2032 battery (included)
- Simple one button pairing with receiver (L-EQW-1REC-1)
- No cumbersome, messy wires for easy installation
- Surface mount using magnet backed with 3M™ tape or screw (included)

12VDC  
24VDC

**FREEDiM**  
WIRELESS CONTROL

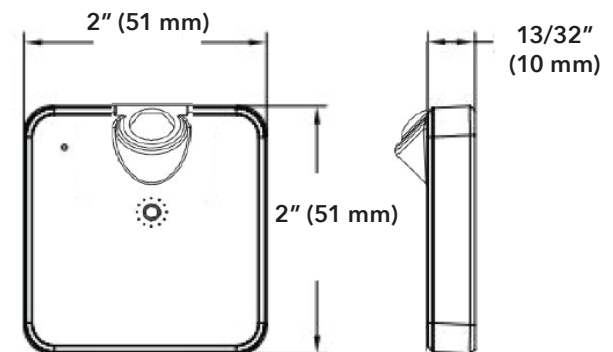
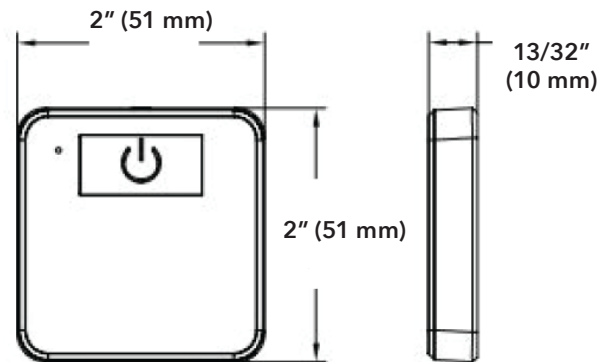

### Wireless Dimmer

- Short touch to switch ON/OFF
- Long touch to dim from 10% - 100%
- Maximum Remote Range: up to 33' (10 m)

### Wireless Dimmer with Motion

- Turns on light when motion is detected
- Turns off light 45 seconds after movement is no longer detected
- Long touch to dim from 10% - 100%
- Maximum Remote Range: up to 33' (10 m)
- Motion Range: 3-10' (1-3 m)

Part #	Description
L-EQW-KITD-**-1	12/24VDC 60W/96W EquiLine Receiver and Wireless Dimmer
L-EQW-KITMD-**-1	12/24VDC 60W/96W EquiLine Receiver and Wireless Dimmer w/ Motion

\*\*Insert (BL) for Black and (NI) for Nickel

**Only one receiver and one dimmer can be paired and are sold together as a kit. You cannot program multiple dimmers to one receiver. If individual parts are needed, please contact Tresco® customer service.**

# RGB-CCT Controller/Receivers



**Features:**

- 60W capacity (12VDC); 96W capacity (24VDC)
- Digital user interface
- Power failure memory
- Simple one-button programming of FREEDiM Series wireless controls
- Compatible Tresco® FREEDiM series RGB or CCT hand and wall controllers (sold separately)
- Works with any 12/24VDC Tresco® RGB or CCT low voltage lights
- Complete with pigtails for RGB or CCT connection
- Tuning of the RGB or Color temperature from 2700K-6500K

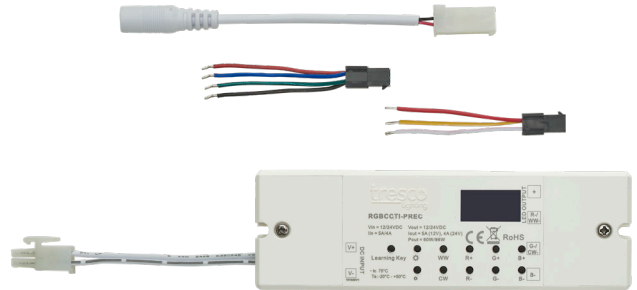

Parent Controller/Receiver  
L-RGBCCT1-PREC-1

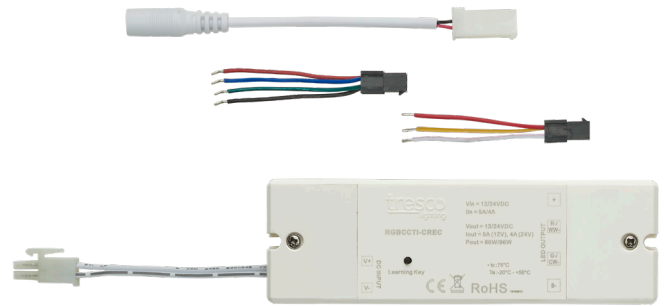

Child Controller/Receiver  
L-RGBCCT1-CREC-1

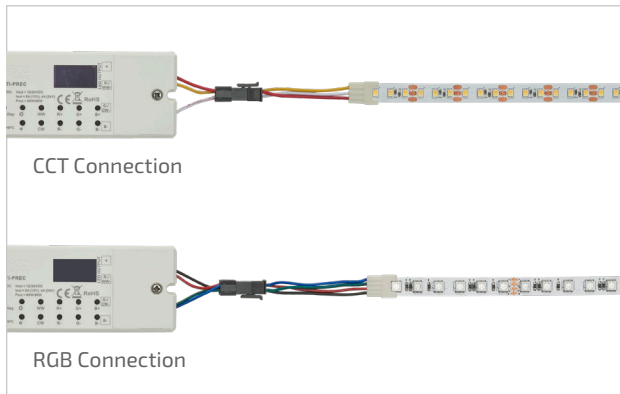

Display in RGB mode. RGB values can be tuned in increments of 1



Display in CCT mode. CCT values can be tuned in increments of 15-16K (Color temperature is range)

Part #	Description
L-RGBCCT1-PREC-1	12/24VDC RGB-CCT Parent Controller/Receiver
L-RGBCCT1-CREC-1	12/24VDC RGB-CCT Child Controller/Receiver

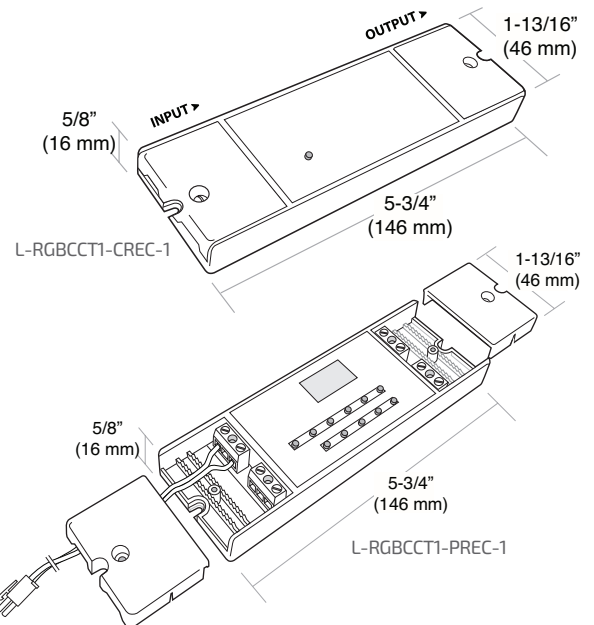

12VDC Setup

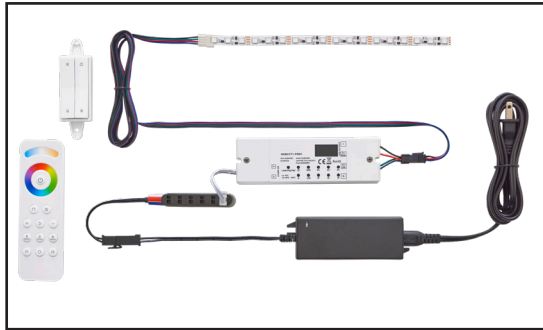

24VDC Setup

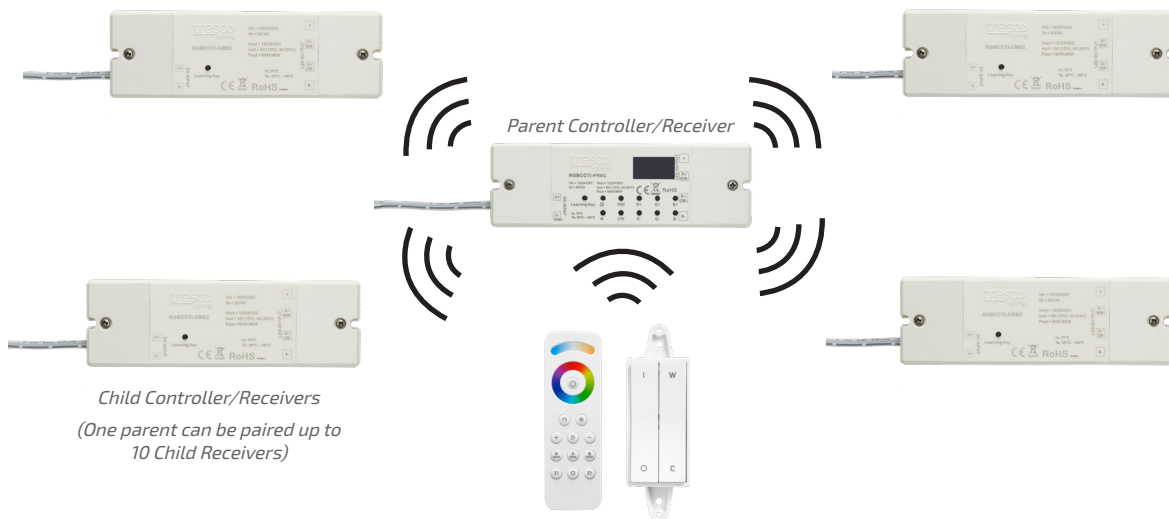
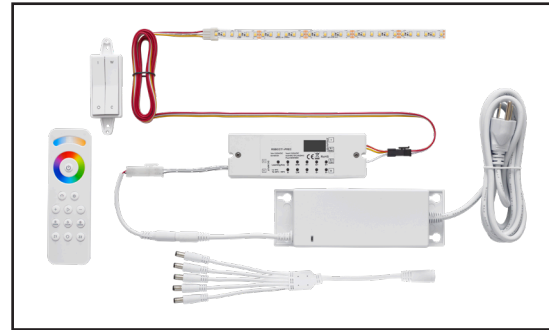

Child Controller/Receivers  
(One parent can be paired up to 10 Child Receivers)

Wireless remote controls 1 parent per zone and 10 child controller/receivers per parent

## RGB-CCT Wall Controllers



PATENT NO. 9,818,559 B2

- (2) configurations: RGB or CCT (white tunable)
- Can be programmed with up to (1) parent and (10) child receivers
- Fits Decora® style wall plates
- 65 ft. (20 m) range of control from dimmer to receiver
- Controls all Tresco® RGB or CCT low voltage lights
- RGB/CCT controller/receivers required (sold separately)
- Long-lasting CR1625/1620 battery (included)

### RGB

Easy touch Red, Green, Blue and on/off/dimming controls

### CCT – White Tunable

Easy touch warm 2700K to daylight 6500K and on/off/dimming controls

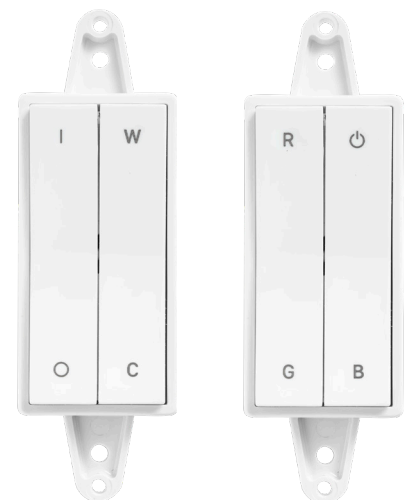

Part #	Description
L-WLD-CCT-WH-1	CCT FREEDiM Deco Wall Dimmer, White
L-WLD-RGB-WH-1	RGB FREEDiM Deco Wall Dimmer, White

# RGB-CCT Wireless Remote



**Features:**

- Intuitive and ergonomic design
- Can control RGB and CCT
- Touch control for color mixing
- Quick set buttons for common CCT and static RGB values
- Program up to (2) separate zones and control independently
- (10) preset RGB sequences with speed control (i.e. fade in, fade out)

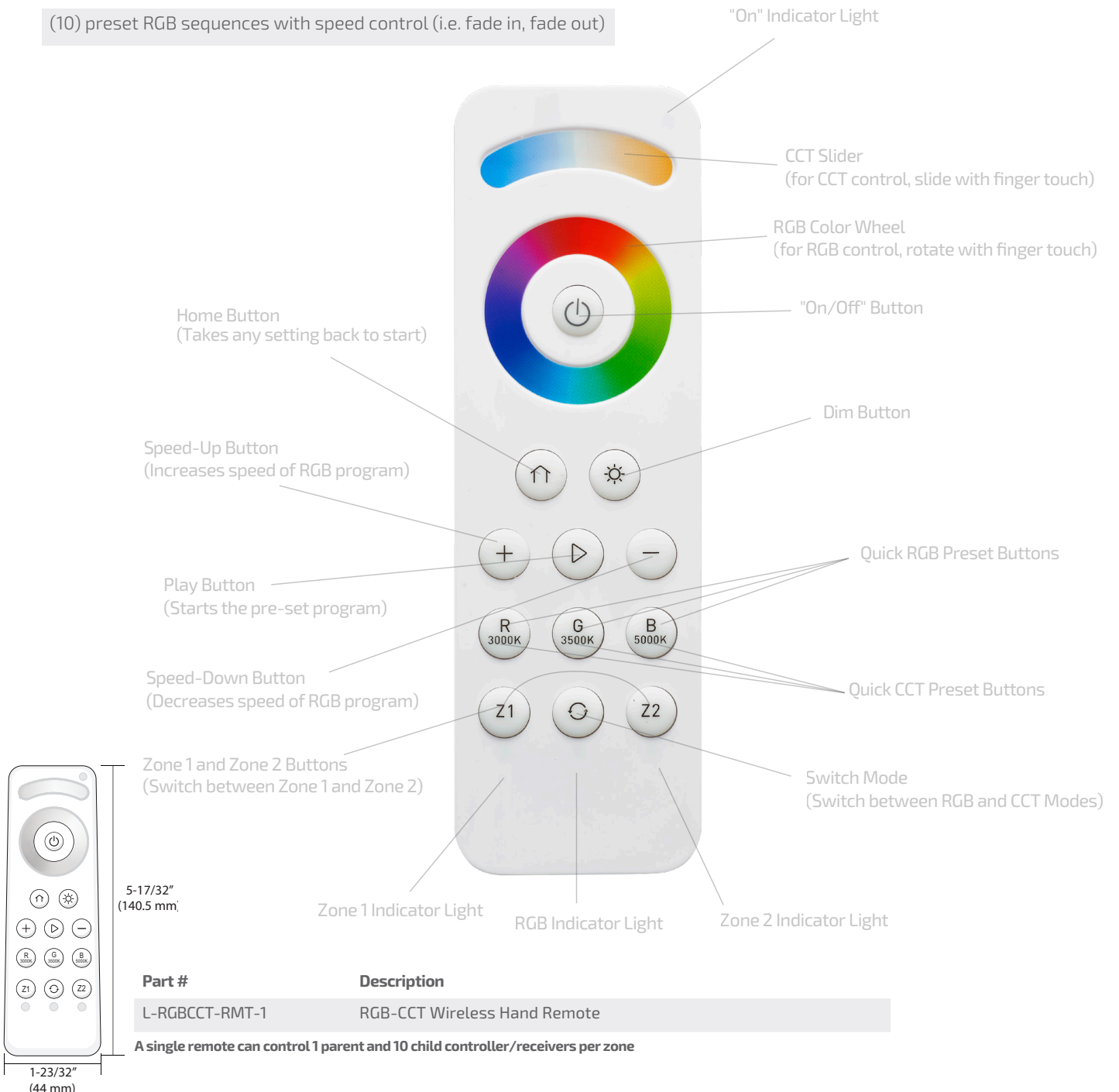

Part #	Description
L-RGBCCT-RMT-1	RGB-CCT Wireless Hand Remote

A single remote can control 1 parent and 10 child controller/receivers per zone



# Wireless Remote Control Dimmers

12VDC  
24VDC

Remote Control LED Dimmers feature radio-frequency, remote-control dimming to adjust lights from anywhere in the room up to 30' (9 m). The remote control provides on/off power and dims lights from 100%-1%.



## Universal Remote Dimmer

Controls up to 12VDC/60W or 24VDC/96W of LED lighting  
Features a built-in memory that recalls the last setting when turned on  
Comes with two remote controls (one as a backup)  
No line of sight required  
Can control multiple dimmers in same room with single remote control for universal dimming  
Dims lights from 100%-1%

## Dedicated Remote Control Dimmer

Controls up to 12VDC/60W or 24VDC/96W of LED lighting  
Features a built-in memory that recalls the last setting when turned on  
No line of sight required  
Comes with two remote controls (one extra, as a backup) that are synchronized to control the same dimmer  
Can use multiple independently controlled dimmers in the same room  
Dims lights from 100%-1%

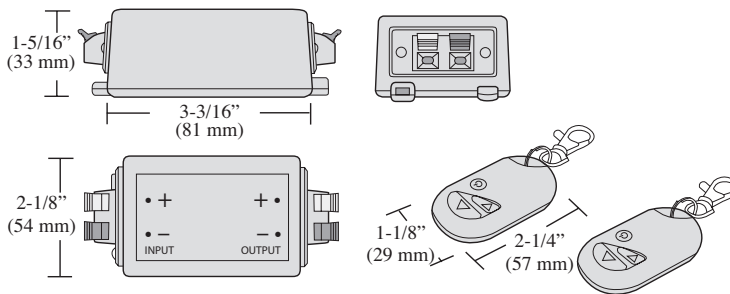

Part #	Description
L-LED-DIMRMT-12V8A-1	LED Dedicated Remote Control Dimmer, 12/24VDC
L-LED-DIMRMT-12V8A-U-1*	LED Universal Remote Control Dimmer, 12/24VDC
L-24VDC3INADP-WH-1	12VDC to 24VDC Controller Adaptor Cord Set White
L-24VDC3INADP-BL-1	12VDC to 24VDC Controller Adaptor Cord Set Black

Adaptor Cord Set required for 24VDC operation.

**\*Recommended not to exceed 3 per room**

Placement of multiple dimmers in a room may be critical for proper function depending on set-up and obstacles.

**IMPROVED DESIGN**

# Round Controllers

12VDC  
24VDC

Max Wattage: 12VDC/60W; 24VDC/96W

79" (2 m) input cord and 6" (152 mm) output cord attached

Controls all Tresco® single color dimmable low voltage lights

Available in a Black or Nickel finish

Improved smaller design allows controllers to be easily recessed using a 1/2" (13 mm) drill bit

Recess or surface mount with included surface mount clip

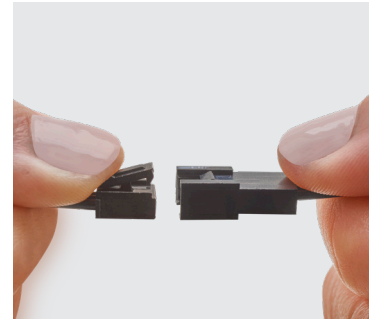

The addition of small connectors allow for wire shortening and easier wire management during install.



### Single Door Sensor

Door open, light on; door closed, light off  
Sensor Range: 1/16" - 2" (2 mm - 50 mm)



### Two Door Sensor

Either door open, light on; both doors closed, light off  
Sensor Range: 1/16" - 2" (2 mm - 50 mm)



### Touch Dimmer

Touch on/off and 0-100% dimming control  
Hold finger down for dimming  
Touch dimmer once to turn on/off  
Power failure memory (retains last setting)



### Motion Sensor

Turns on when human motion is detected  
Sensor Range: 0" - 118" (0 mm - 3000 mm)  
Viewing degree: 120°  
Time on: 30 secs if no motion



Part #	Description
L-RSDS-**-1	12/24VDC 60W/96W Round Single Door Sensor
L-RSDS2-**-1	12/24VDC 60W/96W Round Two Door Sensor
L-RSDIM-NI-1	12/24VDC 60W/96W Round Touch Dimmer, Nickel
L-RSMOT-NI-1	12/24VDC 60W/96W Round Motion Sensor, Nickel

\*\*Available in Black (BL) and Nickel (NI). Surface mount clip packaged with each controller.

Motion Sensor available in Black (BL) with a minimum quantity order. Need AMP mounting block (L-TRANS-MNT-BL-1) if using more than 1 light.

# Profile Controllers

12VDC  
24VDC



(5) profiles to choose from – angled, curved, recessed, round or square

Capacity: 12VDC/60W; 24VDC/96W

(2) configurations: Touch Dimmer and Touch Dimmer/Motion Combo

Power failure memory (retains last setting)

79" (2 m) input and 3" (76 mm) output

Controls all Tresco® dimmable low voltage lights

Various finishes available

## Dimensions

Profile	Length	Width	Height
Square	3-15/16" (100 mm)	23/32" (18 mm)	15/32" (12 mm)
Curved	3-15/16" (100 mm)	1-21/32" (43 mm)	1/2" (13 mm)
Angled	3-15/16" (100 mm)	1-5/32" (29 mm)	1/2" (13 mm)
Round	3-15/16" (100 mm)	13/16" (21 mm)	13/32" (11 mm)
Recessed	5-1/8" (130 mm)	3/4" (19 mm)	5/16" (8 mm)

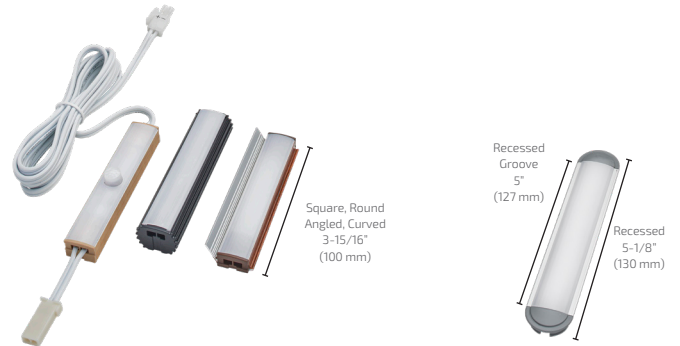

## Touch Dimmer Controller

Touch ON/OFF

Gradual dimming from 100%-5%

Power failure memory (retains last setting)

10-hour automatic energy-saving shutoff

## Touch Dimmer and Motion Controller Combo

Premium Panasonic motion sensor

Touch dimmer function 100/75/50/25/Off

(3) time settings: 30 seconds, 3 minutes, 30 minutes or customization available

Motion sensor can be bypassed

Motion Sensor Range: 0-15' (0-4.5 m)

Dimming function works in motion sensor mode or stand-alone mode

10-hour automatic energy-saving shut off in dimmer only mode

\*Motion sensor time can be customized by Tresco®

Part #	Description
L-XSQRDIMA-XX-1	Dimmer Module for Square Profile
L-XCRVDIMA-XX-1	Dimmer Module for Curved Profile
L-XANGDIMA-XX-1	Dimmer Module for Angled Profile
L-XRNDDIMA-XX-1	Dimmer Module for Round Profile
L-XRECDIMA-XX-1	Dimmer Module for Recessed Profile
L-XSQRCBOYY-XX-1	Dimmer/Motion Sensor Combo for Square Profile
L-XCRVCBOYY-XX-1	Dimmer/Motion Sensor Combo for Curved Profile
L-XANGCBOYY-XX-1	Dimmer/Motion Sensor Combo for Angled Profile
L-XRNDCBOYY-XX-1	Dimmer/Motion Sensor Combo for Round Profile
L-XRECCBOYY-XX-1	Dimmer/Motion Sensor Combo for Recessed Profile

All controllers are 3-15/16" (100 mm) in length except recessed profiles which are 5-1/8" (130 mm)

XX= Insert SC for Satin Clear, BL for Black, DC for Dark Cherry, NSM for Natural Soft Maple  
Round and recessed profiles only available in Satin Clear and Black

30 second, 3 minute, and 30 minute versions of Dimmer/Motion Sensor Combo available.  
YY = 30S (30 second), 3M (3 minute) or 30M (30 minute)

### Mounting:

(Mounting accessories are dependent upon the profile)

**Square/Curved:** Magnet mount (magnet already built-in) with metal plate and u-clips

**Round:** U-Clips

**Angled:** Screw-in

**Recessed:** Rout a channel in wood 21/64" (8.33 mm) minimum depth x .75" (19 mm) width x 5" (127 mm) length and pressure fit this extrusion in place.

# Manual In-Line Rotary Dimmer

12VDC  
24VDC

**Features:**

Capacity: 12VDC/48W; 24VDC/96W

100-0% dimming and on/off power

79" (2 m) input lead and 8" (203 mm) output lead

(2) screws for mounting

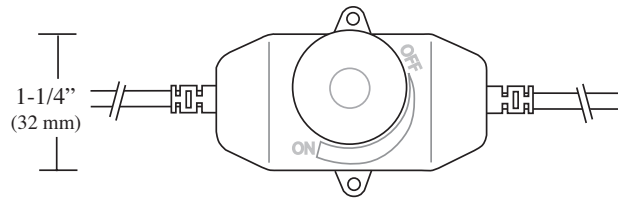
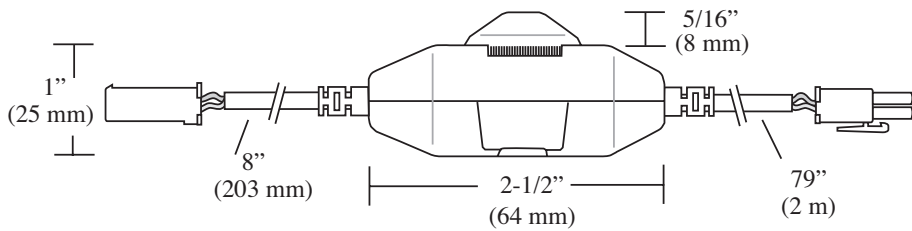

Part #	Description
L-LED-DIMCON-BL-1	LED Black Inline Rotary Dimmer, 12VDC/24VDC
L-LED-DIMCON-WH-1	LED White Inline Rotary Dimmer, 12VDC/24VDC
L-24VDC3INADP-BL-1	12VDC to 24VDC Controller Adaptor Cord Set Black
L-24VDC3INADP-WH-1	12VDC to 24VDC Controller Adaptor Cord Set White

Adaptor Cord Set required for 24VDC operation.



# Round Switch

12VDC  
24VDC

Capacity: 12VDC/60W; 24VDC/96W



Front View



Available in  
Black and  
White

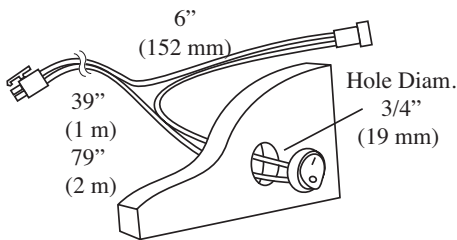
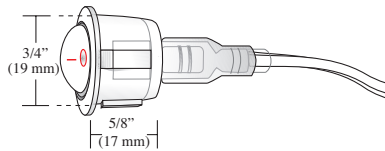
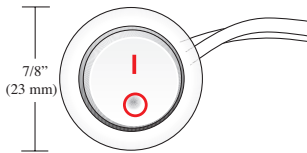

**Part #**

**Description**

L-RDSW-1M-BL-1	Black Rocker Switch w/ 39" (1 m) Lead, 12/24VDC
L-RDSW-1M-WH-1	White Rocker Switch w/ 39" (1 m) Lead, 12/24VDC
L-RDSW-2M-BL-1	Black Rocker Switch w/ 79" (2 m) Lead, 12/24VDC
L-RDSW-2M-WH-1	White Rocker Switch w/ 79" (2 m) Lead, 12/24VDC
L-24VDC3INADP-BL-1	12VDC to 24VDC Controller Adaptor Cord Set Black
L-24VDC3INADP-WH-1	12VDC to 24VDC Controller Adaptor Cord Set White

3/4" (19 mm) hole required.

Adaptor Cord Set required for 24VDC operation.

# Install Accessories

## Wire Channel



### Features:

Plastic channel for wire management

Available in (3) finishes: Black, Brown and White

Sold in 5' (1.5 m) lengths

Easily cut to size in the field

Durable adhesive mounting

Part #	Description
L-WM5-BL-1	5' (1.5 m) Wire Management Channel Black
L-WM5-BR-1	5' (1.5 m) Wire Management Channel Brown
L-WM5-WH-1	5' (1.5 m) Wire Management Channel White

## 12/24VDC Class 2 Wire and DIY Connectors

Part #	Description
L-16CL2-WH50-1	50' (15 m) Roll 16 AWG 12/24VDC Class 2 Wire White
L-LED-WCON-WH-1	12/24VDC DIY Barrel Connectors White (1 bag of 10)
L-LED-WCON-BL-1	12/24VDC DIY Barrel Connectors Black (1 bag of 10)

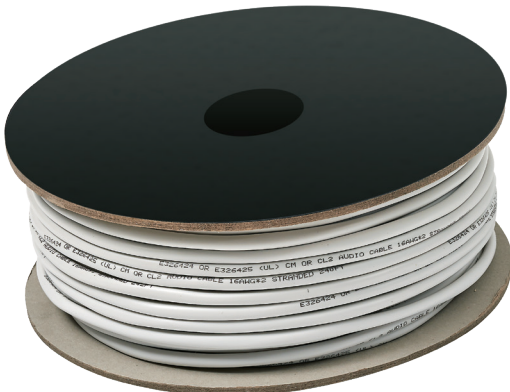

See Sales Support section (page# 195) for instructions on how to use Class 2 wire with Barrel Connectors.

Wire rated for low-voltage in-wall use



(4) barrel connectors required per in-wall and light fixture wire junction.

## AMP® Connector and Extractor



**Part #**

L-PINEXT-1

**Description**

AMP® Connector Extraction Tool

L-MALE-AMP-10-1

AMP® Connector for Light Fixture (box of 10)

Pin Extractor safely removes AMP® Connectors.

## VHB Tape



**Part #**

L-VHBTPE-1134-1

**Description**

7/16" (11 mm) x 111-1/2' (34 m) VHB Adhesive Tape Roll

Automotive grade VHB tape can be used to mount all fixtures or as a base layer for mounting Tape LED products.

## Starter/Extension Cord

**Features:**

Low-voltage wire

Used to extend the starter leads for any Tresco® lights

7 lengths (12VDC); 3 lengths (24VDC)

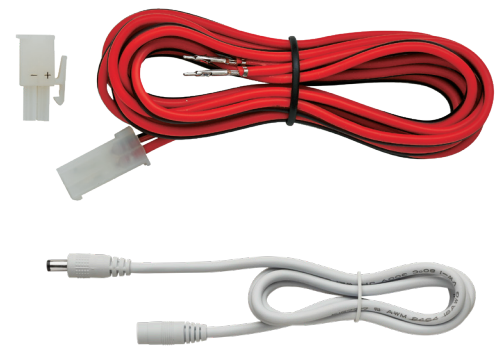

**12VDC**

**Part #**

L-LED-LINKD-8-1

**Description**

8 cm (3") 12VDC Starter/Link/Extension Cord

L-LED-LINKD-15-1

15 cm (6") 12VDC Starter/Link/Extension Cord

L-LED-LINKD-25-1

25 cm (10") 12VDC Starter/Link/Extension Cord

L-LED-LINKD-60-1

60 cm (24") 12VDC Starter/Link/Extension Cord

L-LED-LINKD-120-1

120 cm (48") 12VDC Starter/Link/Extension Cord

L-LED-LINKD-180-1

180 cm (72") 12VDC Starter/Link/Extension Cord

L-LED-LINKD-245-1

245 cm (96") 12VDC Starter/Link/Extension Cord

**24VDC**

**Part #**

L-24BBEXT-1M-1

**Description**

1 m (39") 24VDC ML/FML Barrel Extension, White

L-24BBEXT-2M-1

2 m (79") 24VDC ML/FML Barrel Extension, White

L-24BBEXT-3M-1

3 m (119") 24VDC ML/FML Barrel Extension, White

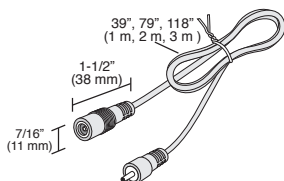
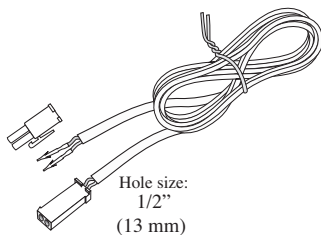

## Phillips Screwdriver



Part #	Description
L-P1SCRWDR-1	#1 Phillips Screwdriver

## Mini Flathead Screwdriver



Part #	Description
L-MFSCRWDR-1	Mini Flathead Screwdriver



## Tools of the Trade Starter Kit



### Starter Kit Includes:

2 mount blocks	Mini flathead screwdriver	(1) 17/32" drill bit
50' (15 m) roll of class 2 wire	AMP® extractor	VHB tape
10 AMP® connectors	10 barrel connectors	15" (381 mm) canvas bag
Phillips screwdriver	10 wire management clips	



#### Starter Kit:

Part #	Description
L-TOOLKIT-1	Tools of the Trade Tool Bag Starter Kit

#### Replacement Items:

Part #	Description
L-16CL2-WH50-1	50' (15 m) Roll 16 AWG 12/24VDC Class 2 Wire White
L-TRANS-MNT-BL-1	Extra 6-Snap Mounting Block
L-MALE-AMP-10-1	AMP® Connector for Light Fixture (1 bag of 10)
L-WCLP-WH-1	Wire Management Adhesive Clips White (1 bag of 10)
L-LED-WCON-WH-1	12/24VDC DIY Barrel Connectors White (1 bag of 10)
L-LED-WCON-BL-1	12/24VDC DIY Barrel Connectors Black (1 bag of 10)
L-DB1732-1	17/32" (13 mm) Drill Bit
L-P1SCRWDR-1	#1 Phillips Screwdriver
L-MFSCRWDR-1	Mini Flathead Screwdriver
L-PINEXT-1	AMP® Connector Extraction Tool
L-VHBTPE-1134-1	7/16" (11 mm) x 111-1/2' (34 m) VHB Adhesive Tape Roll



CLASS 2 5VDC 1A  
ENDC



A hand is shown on the left side of the frame, holding a glowing green, spherical object. The background is a vertical gradient of purple, transitioning from a lighter shade on the left to a darker shade on the right. The word "TECHNOLOGY" is written in white, uppercase letters on a dark purple rectangular background in the center-right of the image.

**TECHNOLOGY**

# Swidget



Upgrade your space with a simple swap. Replace your existing switch or outlet with a technology-ready Swidget Device. Add your choice of Wi-Fi enabled inserts and control your lights, program schedules, create scenes, set automations and more with the Swidget App, or pair with Amazon Alexa or Google Home to enable voice commands. A future-proof versatile solution for a connected smart home.

### Features:

Future Proof - convenient Over-The-Air (OTA) upgrades allow you to expand capabilities right from your Swidget App

Modular System - interchangeable inserts allow you to swap technologies as your needs change or new technology emerges

Compatible with all Tresco® low voltage LED lighting

More Power for High Current Devices - 20A Outlet offers the largest smart capacity on the market

User Safe - devices are designed with tamper-resistant outlets and certified Class 2



## PLUG & PLAY TECHNOLOGY

Upgrading your space is as easy as 1-2-3.

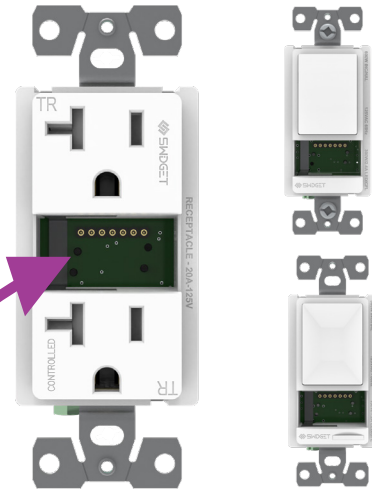

1. Select and Install Your Device



2. Choose Your Desired Insert



Interchangeable Wi-Fi Enabled Inserts



3. Control Your Smart Home



Minimalistic Design



# USE THROUGHOUT THE HOME



**Night Light**  
20A Outlet with  
Wi-Fi Control + Guide/Night  
Light Insert

*Free up both plugs and add a night  
light directly into your outlet*



**Working Together**  
Standard Switch with Wi-Fi  
Control + Motion Sensor Insert,  
20A Outlet with Wi-Fi Control  
Insert

*Setup devices to trigger one  
another in the Swidget App!  
Connect your Wi-Fi enabled outlet  
and switch so lighting  
automatically turns on and off  
when you enter and leave a room*

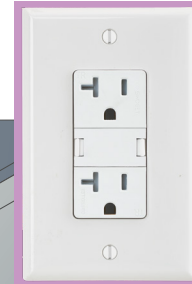

**Parental Control**  
20A Outlet with  
Wi-Fi Control Insert

*Set a schedule to automatically  
turn off gaming consoles or  
other small electronics at  
specific times*



**Control Cabinet Lighting**  
Dimmer Switch  
with Wi-Fi Control Insert

*Automatically turn on/off  
and dim your lights based  
on your schedule*

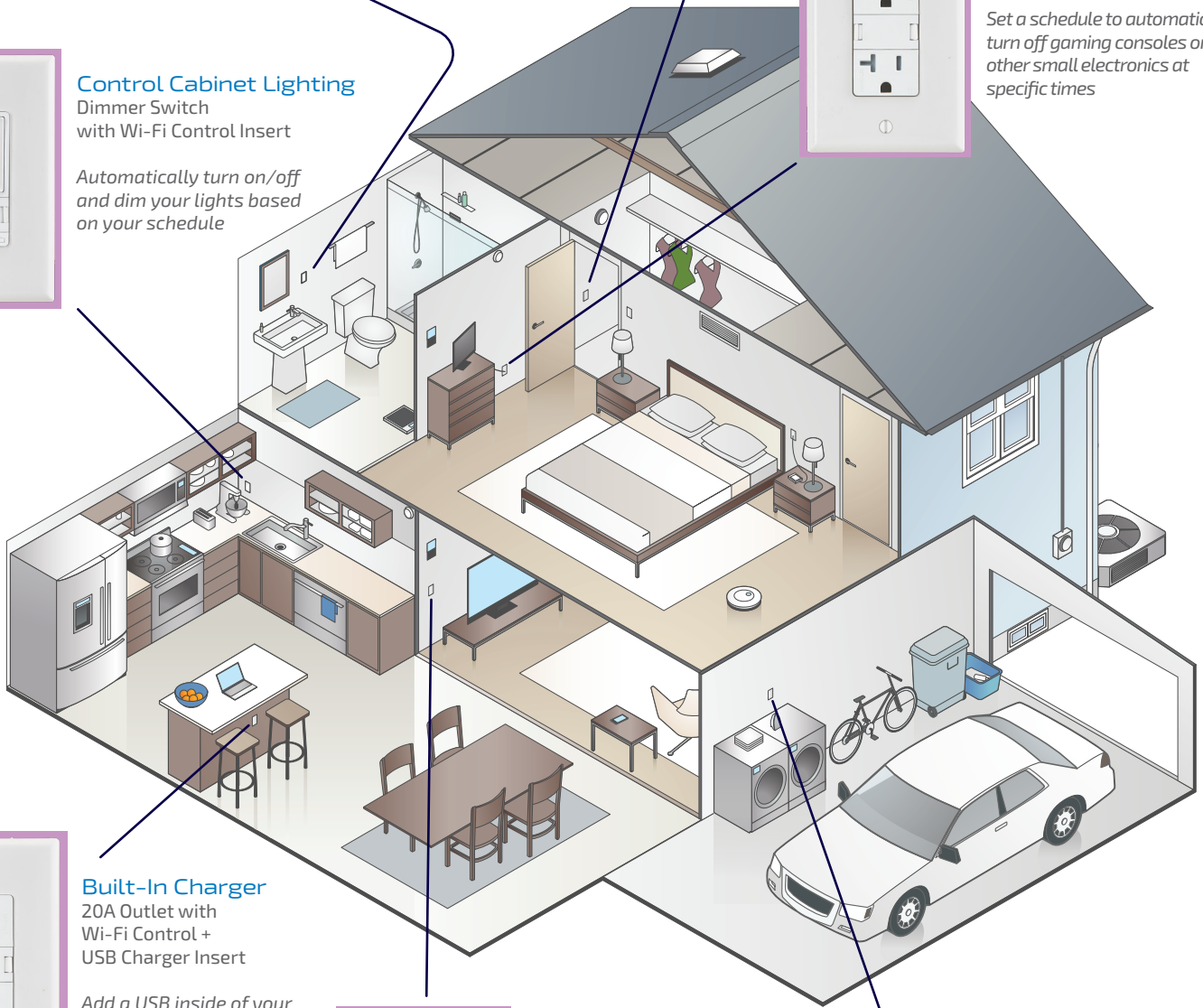

**Built-In Charger**  
20A Outlet with  
Wi-Fi Control +  
USB Charger Insert

*Add a USB inside of your  
outlet for fast,  
convenient charging*



**Vacation Schedule**  
Dimmer Switch with  
Wi-Fi Control Insert

*Set lights to automatically  
turn on/off at different times  
of the day while you are away*



**Automatic  
Lights**  
Standard Switch with  
Wi-Fi Control +  
Motion Sensor Insert

*Create an automation  
to automatically turn  
off your lights when  
the garage is  
unoccupied*

### 3 DEVICES TO CHOOSE FROM

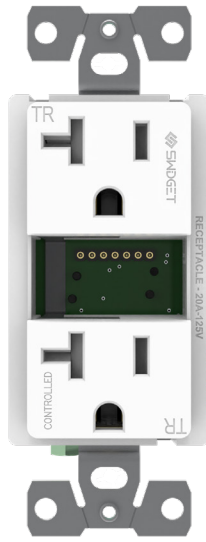

20A Outlet

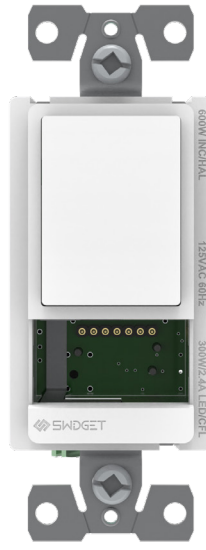

Standard Switch

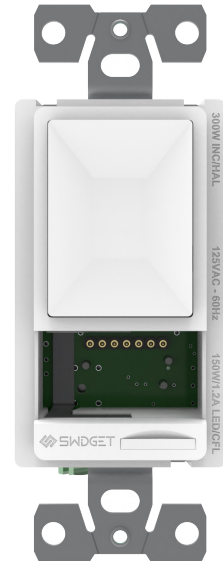

Dimmer Switch

### 4 SWAPPABLE INSERTS TO CHOOSE FROM



Wi-Fi Control



Wi-Fi Control + Motion Sensor

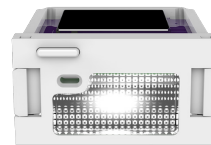

Wi-Fi Control + Guide/Night Light



Wi-Fi Control + USB Charger

Additional special-order items available, contact Tresco® or your local sales representative for more information

### CONTROL YOUR HOME FROM YOUR PHONE



#### Download the App

With knowledge and control at your fingertips, the Swidget App allows you to control your device while monitoring power consumption accurately and in real-time.

- Power On/Off your outlet or switch
- Program schedules, create scenes and set automations
- Monitor your energy consumption and set automatic notifications including when the power consumption is too high
- Connect inserts to trigger one another for a complete smart home system

#### Voice Control

Control your Swidget Wi-Fi connected inserts with your voice using Alexa, Google Assistant and IFTTT enabled devices.



## STEP 1: CHOOSE YOUR DEVICE

Install once, upgrade effortlessly. Install your Swidget outlet or switch using your existing wiring and add an insert for smart home functionality without the clutter.

### 20A OUTLET

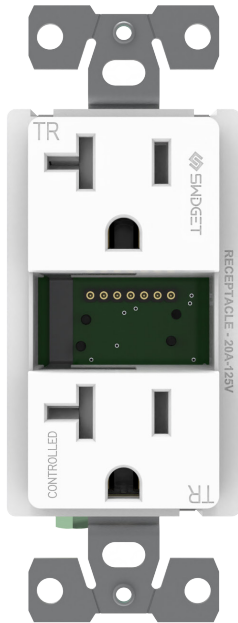

Customize your space. The smart-ready outlet gives you control and allows you to monitor your power accurately and in real-time. The only smart device that uses energy insights to provide notification alerts to help save you money and reduce energy consumption.

#### Features:

Independent power monitoring for each of the (2) receptacles with a Wi-Fi enabled insert and the Swidget App

Tamper resistant shutters for safe operation

Neutral wire required for installation

Wireless control of the bottom receptacle with a Wi-Fi enabled insert

Installs like a standard wall receptacle using the same wiring

Indoor use only

5-Year Limited Warranty

Input Power Rating: 125VAC, 20A

Outlet Receptacle Configuration: NEMA 5-20R

Environmental: Indoor only

Testing and Code Compliance: UL 498 / UL1310, CSA C22.2 #42, #223 (Canada and US)

Operating Temperature: 14F to 104F (-10C to 40C)



Interchangeable inserts sold separately



Fits all electrical boxes 3" x 2" x 2.5" and larger

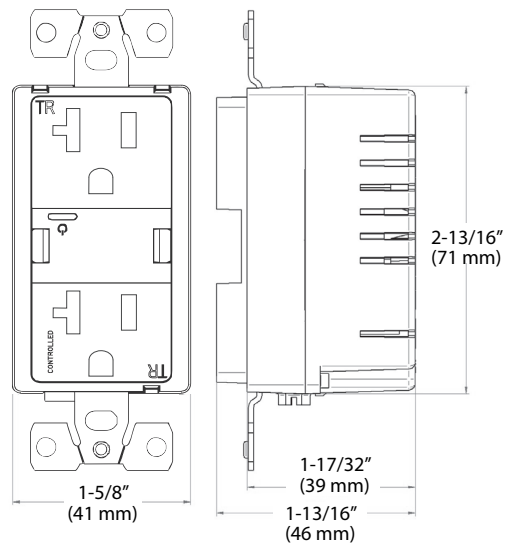

#### 20A Outlet

Part #	Description
L-R1020SWA-1	120VAC 2.4KW Swidget Outlet, w/o Insert, White

Note: Electrician required for install. Works with all standard Rocker Switch plates (not included).

## STANDARD SWITCH

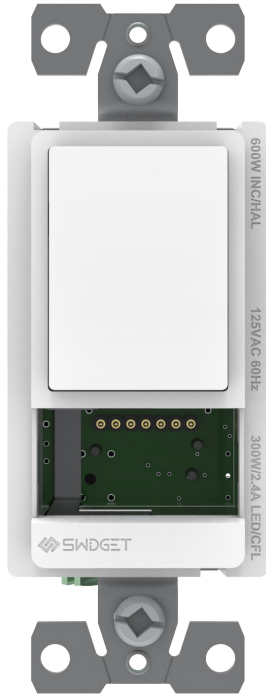

No longer just on or off. The smart-ready switch is a customizable switch designed for lighting and fan applications.

### Features:

Single pole and 3-way wiring compatible for lighting and fan applications

Direct power monitoring and capability for scene programming with a Wi-Fi enabled insert

Neutral wire required for installation

Indoor use only

5-Year Limited Warranty

Input Power Rating: 125VAC, 5A

LED/CFL Load Rating: 300W

Testing and Code Compliance: UL 498 / UL1310, CSA C22.2 #42, #223 (Canada and US)

Environmental: Indoor only

Operating Temperature: 14F to 104F (-10C to 40C)



Interchangeable inserts sold separately

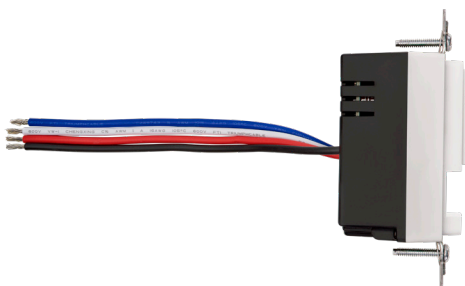

Fits all electrical boxes 3" x 2" x 2.5" and larger

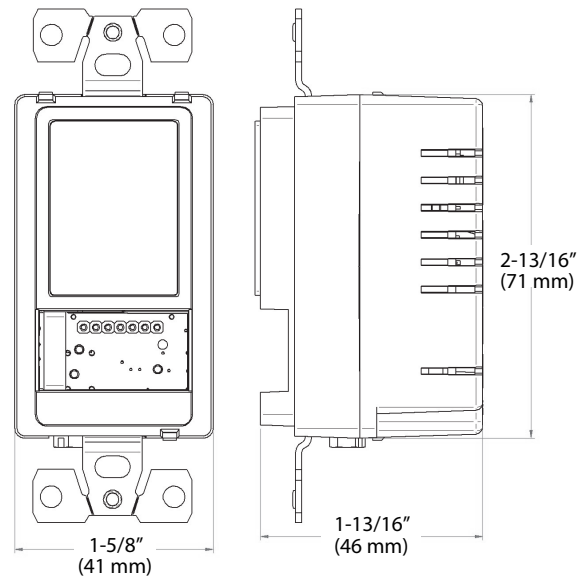

### Standard Switch

Part #	Description
L-S16001WA-1	120VAC 300W/600W Swidget Toggle Switch, w/o Insert, White

Note: Electrician required for install. Works with all standard Rocker Switch plates (not included).



# DIMMER SWITCH

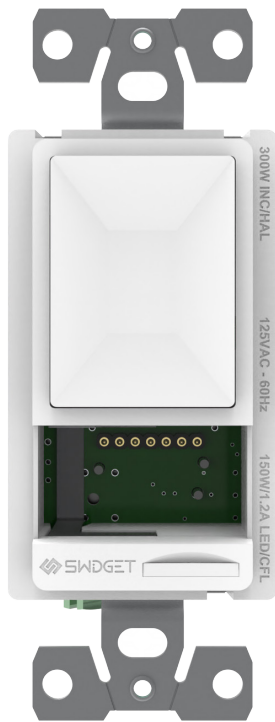

Transform your space. The smart-ready dimmer allows you to set the perfect atmosphere in any room.

**Features:**

Designed with industry-leading anti-flicker technology for dimmable LEDs

Unique ON/OFF/Dimmer control in a single pad

Direct power monitoring and capability for scene programming with a Wi-Fi enabled insert

Neutral wire required for installation

Compatible with all Tresco® dimmable power supplies

Indoor use only

5-Year Limited Warranty

Input Power Rating: 125VAC, 2.5A

LED/CFL Load Rating: 150W

Incandescent/Halogen Load Rating: 300W

Number of Poles: Single (1p)

Testing and Code Compliance: UL 1472 / UL1310, CSA C22.2 #184.1, #223 (Canada and US)

Compatibility: NEMA SSL 7A Compliant

Environmental: Indoor only

Operating Temperature: 14F to 104F (-10C to 40C)



Interchangeable inserts sold separately

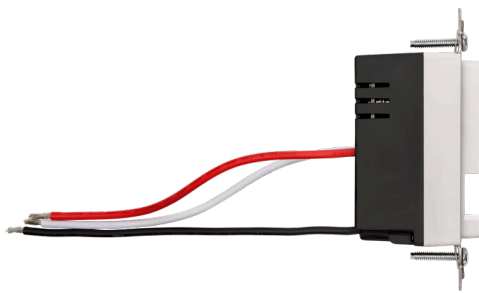

Fits all electrical boxes 3" x 2" x 2.5" and larger

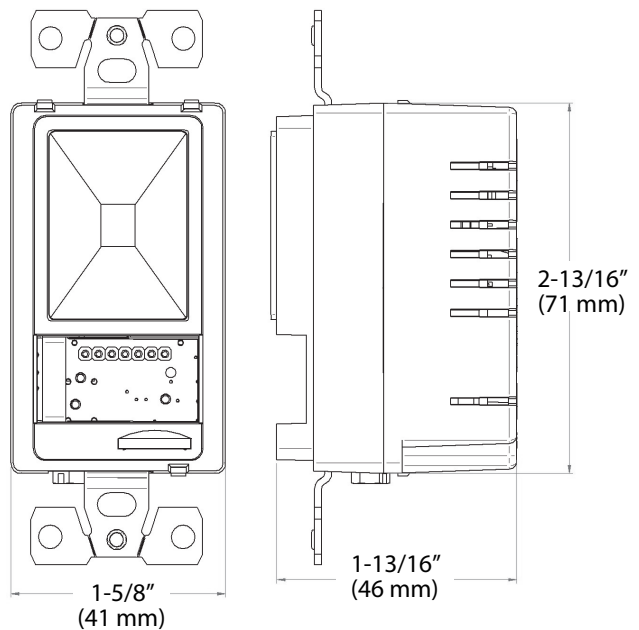

**Dimmer Switch**

Part #	Description
L-SD3001WA-1	120VAC 150W/300W Swidget Dimmer Switch, w/o Insert, White

Note: Electrician required for install. Works with all standard Rocker Switch plates (not included).

## STEP 2: CHOOSE YOUR INSERT Class 2

You've selected your device; now add technology without the clutter. Wi-Fi enabled smart control inserts are easily installed, removed or replaced as your needs change or new technology emerges. No need to call an electrician - add your new insert and connect to the Swidget App to control your device from anywhere.

### WI-FI CONTROL INSERT

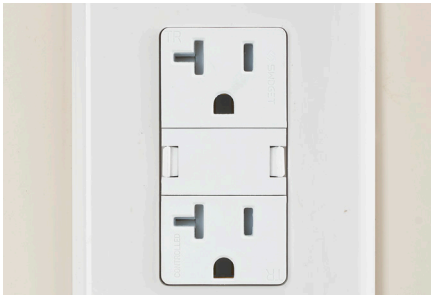
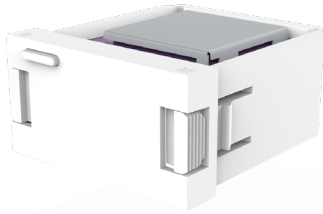

Insert into any Swidget device

Smart home solution. This Wi-Fi enabled insert gives you complete wireless control, connect to the Swidget App and control your device from anywhere!

**Features:**

- 2.4GHz, Wi-Fi 6 router compatible
- Easily replaced, no electrician required
- Independent power monitoring
- Regular wireless upgrades to expand capabilities right from your Swidget App
- Works with Amazon Alexa, Google Assistant and IFTTT
- 2-Year Limited Warranty

Wireless Standard: Wi-Fi 802.11g  
 Average Power Rating: 5VDC @ 40mA (Class 2)  
 Device Upgrades: OTA  
 Environmental: Indoor only  
 Operating Temperature: 14F to 104F (-10C to 40C)

**Wi-Fi Control Insert**

Part #	Description
L-WI000UWA-1	Swidget Wi-Fi Control Insert, White

### WI-FI CONTROL + GUIDE/NIGHT LIGHT INSERT

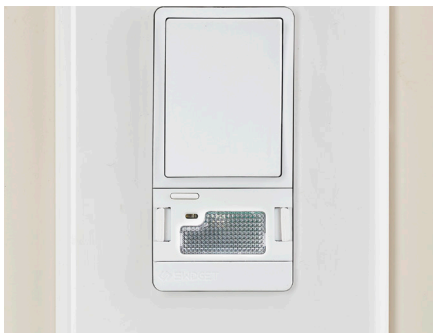
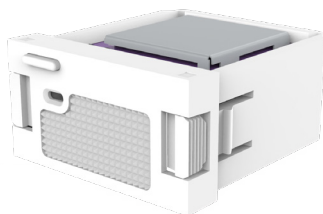

Insert into any Swidget device

Illuminate the way. The Wi-Fi enabled Guide/Night Light insert provides all the features of a standard night light using high-efficiency LED technology to brighten any dark room or space safely.

**Features:**

- 2.4GHz, Wi-Fi 6 router compatible
- Basic night light functionality with an automatic light sensor trigger
- Warm white high efficiency LED
- Easily replaced, no electrician required
- Independent power monitoring
- Regular wireless upgrades to expand capabilities right from your Swidget App
- Works with Amazon Alexa, Google Assistant and IFTTT
- 2-Year Limited Warranty

Wireless Standard: Wi-Fi 802.11g  
 Device Upgrades: OTA  
 LED Color: Warm White  
 Trigger: Automated light sensor  
 Environmental: Indoor only  
 Operating Temperature: 14F to 104F (-10C to 40C)

**Wi-Fi Control + Guide/Night Light Insert**

Part #	Description
L-WI002UWA-1	Swidget Wi-Fi Control + Guide Light Insert, White

## WI-FI CONTROL + MOTION SENSOR INSERT

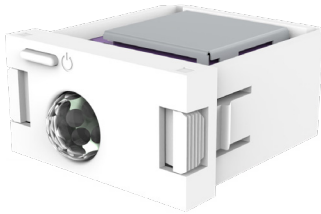

Insert into any Swidget device

### Wi-Fi Control + Motion Sensor Insert

Smart Home Savings. With occupancy and vacancy detection, this 2-in-1 Wi-Fi enabled insert makes your space more secure and energy efficient.

#### Features:

2.4GHz, Wi-Fi 6 router compatible

Wireless Infrared Detection (PIR) Panasonic Motion Sensor

Vacancy timer adjustable between 1-60 minutes

120° detection angle / 10' (3 m) detection range

Easily replaced, no electrician required

Independent power monitoring

Regular wireless upgrades to expand capabilities right from your Swidget App

Works with Amazon Alexa, Google Assistant and IFTTT

2-Year Limited Warranty

Wireless Standard: Wi-Fi 802.11g

Device Upgrades: OTA

Detection Angle: 120 degrees

Detection Range: 10' (3 m)

On Time: Adjustable; 1-60 minutes

Environmental: Indoor Only

Operating Temperature: 14F to 104F (-10C to 40C)

#### Part #

L-WI004UWA-1

#### Description

Swidget Wi-Fi Control + Motion Insert, White

## WI-FI CONTROL + USB CHARGER INSERT

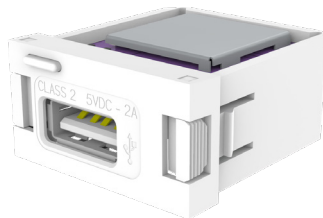

Insert into any Swidget device

### Wi-Fi Control + USB Charger Insert

Charge it up. The Wi-Fi enabled USB Charger insert provides a standard Type A USB charger to allow for the fast charging of your devices.

#### Features:

2.4GHz, Wi-Fi 6 router compatible

USB output up to a 2.0A rating

Class 2 output certified

BC1.2 compliant smart charging configuration

Easily replaced, no electrician required

Independent power monitoring

Regular wireless upgrades to expand capabilities right from your Swidget App

Works with Amazon Alexa, Google Assistant and IFTTT

2-Year Limited Warranty

Wireless Standard: Wi-Fi 802.11g

Output Power Rating: 5VDC +/- 5% @ 2A (Class 2)

Device Upgrades: OTA

USB Output Connector: Type A

Smart Charge Detection: BC1.2 Compliant

Environmental: Indoor Only

Operating Temperature: 14F to 104F (-10C to 40C)

#### Part #

L-WI001UWA-1

#### Description

Swidget Wi-Fi Control + USB Insert, White

## SPECIAL ORDER INSERTS

Additional special order items available, contact Tresco® or your local sales representative for more information.

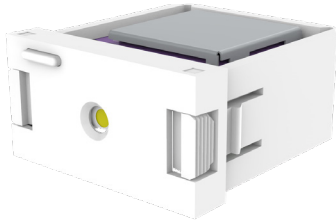

**WI-FI CONTROL + POWER OUT  
LIGHT INSERT**

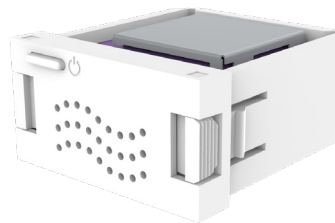

**WI-FI CONTROL + AIR QUALITY  
SENSOR INSERT**



**WI-FI CONTROL + TEMPERATURE,  
HUMIDITY AND MOTION SENSOR INSERT**

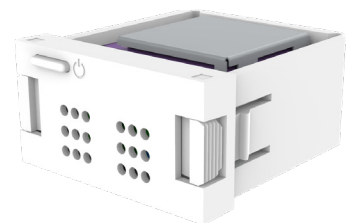

**WI-FI CONTROL + TEMPERATURE AND  
HUMIDITY SENSOR INSERT**





## TYPICAL SETUP

### PLUG-IN POWER SUPPLY

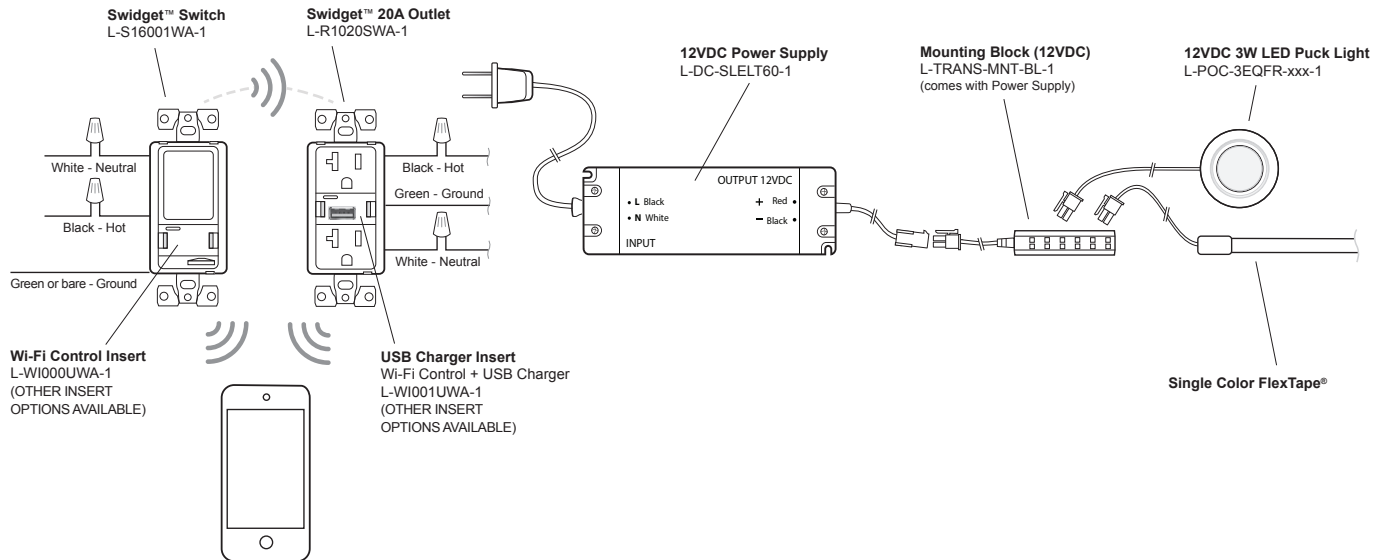

### HARDWIRE POWER SUPPLY

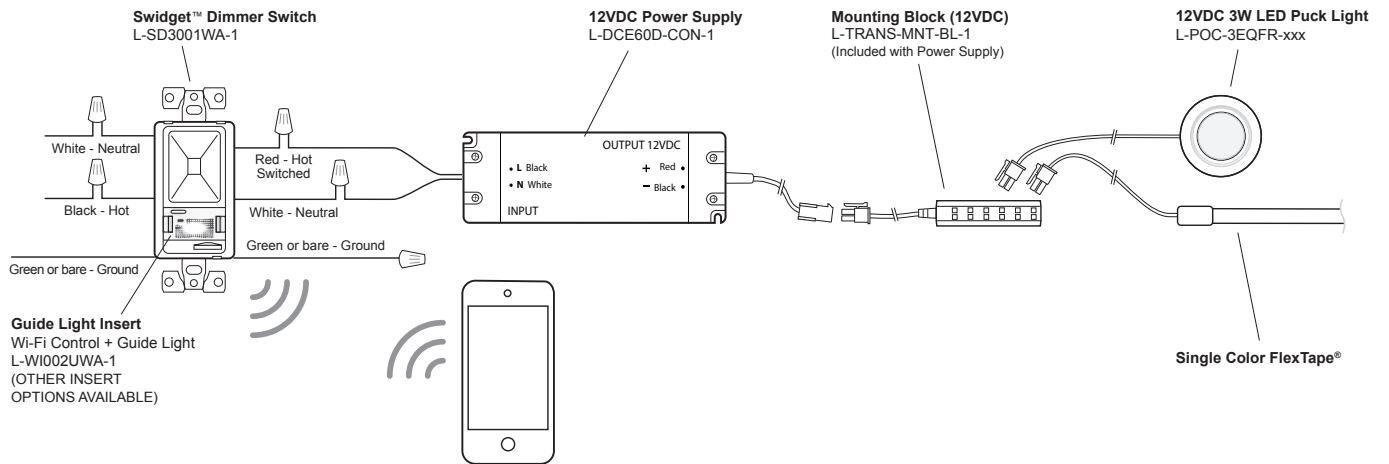

# Basic Specifications to Install Tresco 12VDC Lights With a PLUG-IN Power Supply

To control each light individually, use [Option 1](#).

To control all lights at the same time, use [Option 2](#).

Note: Before making final connections, make sure to add up all the wattage of the lights used. Do not exceed the wattage rating of the Power Supply and each Controller.

**Note: 12VDC plug-in Power Supplies are dimmable on the 12VDC side only.**

- LEGEND:**
- A. Power Supply**  
Select a Plug-In Power Supply.  
For example: an 18W Power Supply can power up to (18) 1W Lights or (6) 3W Lights.
  - B. Mounting Block**  
(1) Mounting Block is included with each plug-in Power Supply.  
Up to (6) Controllers and/ or Lights can plug into (1) Mounting Block.
  - C. Controllers**  
Select from several different types of Tresco Controllers.
    1. Remote Control Dimmer
    2. Manual Rotary Dimmer
    3. Motion Sensor Controls
    4. Touch Dimmer Controls
    5. Door Sensors
  - D. Tresco Lights**  
12VDC LED Lights

**Option 1:** Up to six Controllers plugged into (1) Mounting Block

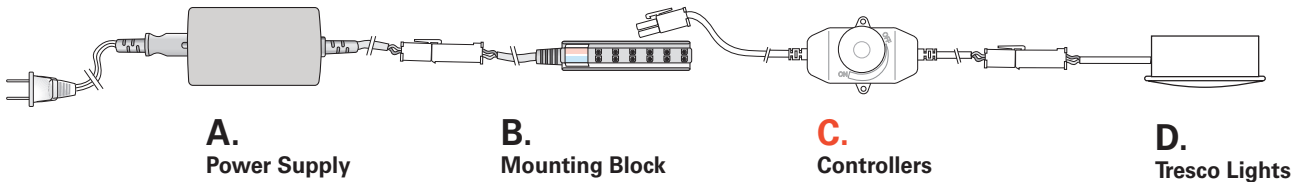

**Option 2:** One Controller plugged in before the Mounting Block

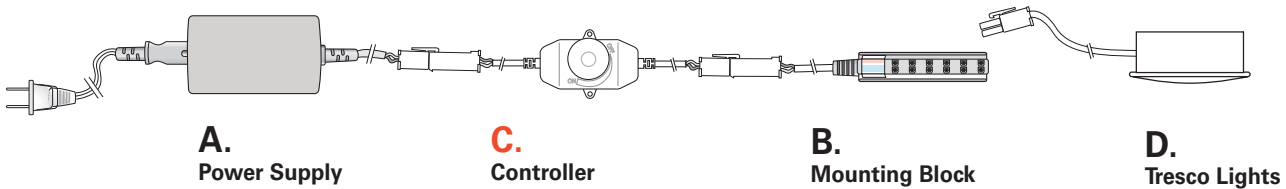

**Typical Installation Showing One Controller for All Lights (Linear vs. Puck)**

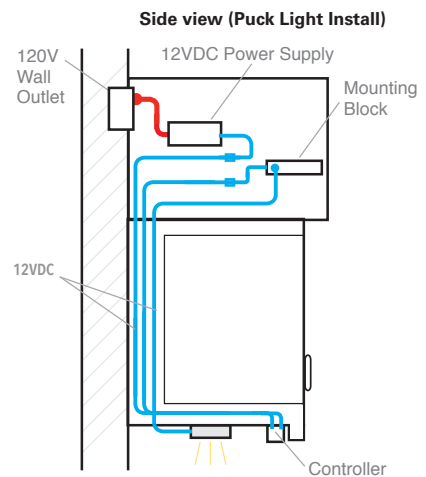
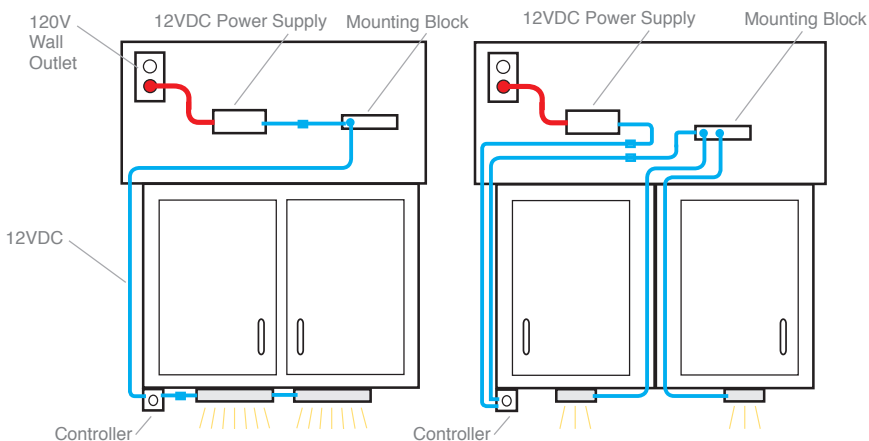

# Basic Specifications to Install Tresco 12VDC Lights With a HARDWIRE Power Supply

To turn all lights on/off at the same time, use a [Wall Switch](#).

To control (dim) all lights at the same time, use a [Wall Dimmer](#).

Note: Before making final connections, make sure to add up all the wattage of the lights used. Do not exceed the wattage rating of the Power Supply.

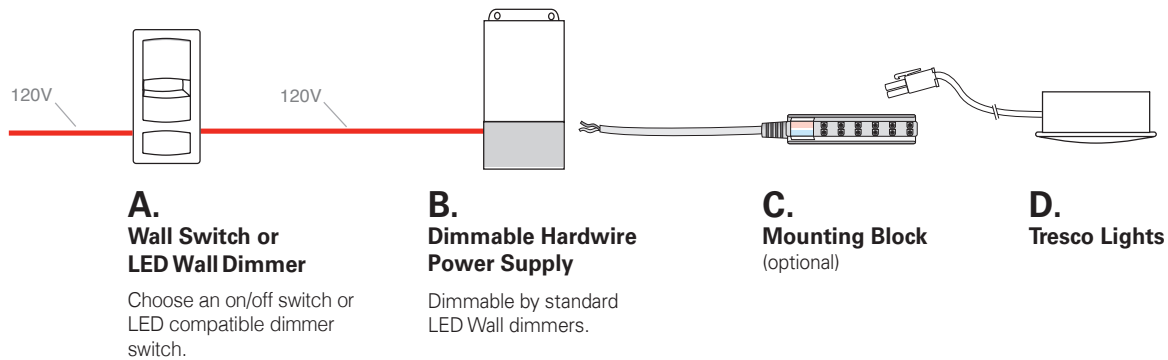

**Caution:** DO NOT dim a receptacle. This is a potential hazard and can cause lights to flicker as well as damage Power Supply.

## Typical Hardwire Installation for 12V Pocket® Lights

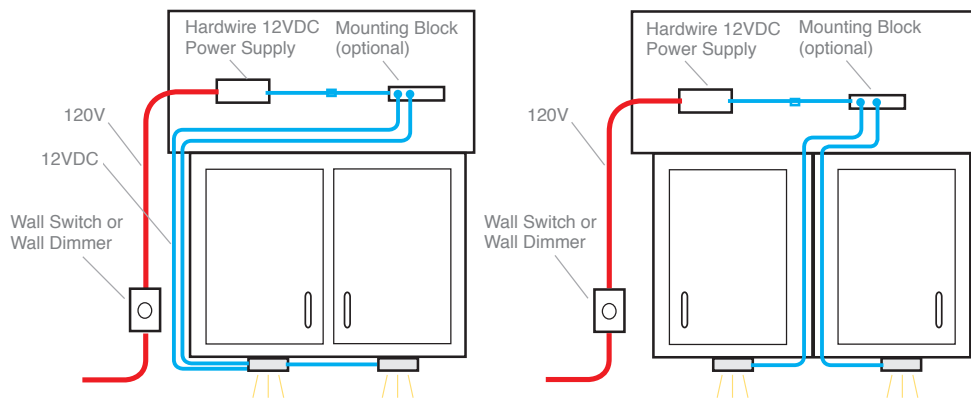

**LEGEND:**  
Red = 120V Wiring  
Blue = 12VDC Wiring

## Typical Hardwire Installation for 12V Linear Lights

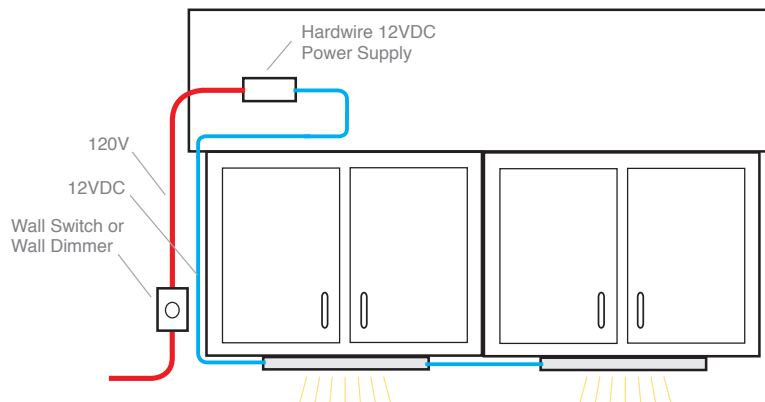

### Side view (Linear Install)

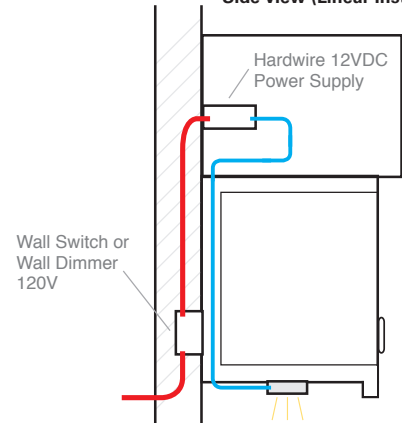

# How to Wire a Kitchen with Tresco 12VDC Lights for Frameless or Framed Cabinets

- To wire a kitchen with Tresco 12V lights, first roughly lay out lighting system to help verify final positioning of all components. Make sure to add up all the wattage of the lighting system. Do not exceed the wattage rating of the Power Supply. If using a Tresco D.I.Y. Controller, do not exceed the wattage of the Controller.

Wires that are attached to or accompany Tresco® lighting systems are not approved for in-wall use. Class 2 wire must be used (purchased separately). Class 2, 16-gauge wire is the minimum for in-wall applications.

**For in-wall wiring** – typically used for frameless cabinets – use 16-gauge Class 2 wire (minimum) to route wire through kitchen walls (see 1st illustration below).

**For outside of wall wiring** – typically used for framed cabinets – use wires provided with Tresco lighting fixtures with appropriate link and extension leads (LINKD series) that are available in several lengths.

## IN-WALL Wiring:

### Typical for FRAMELESS Cabinets

(example installation of 12VDC Linear Lights)

**Note:** A licensed electrician should be consulted for wiring through walls and other permanent structures. When mounting and wiring a light system, follow all local electric codes and the National Electrical Code (NEC).

**LEGEND:**  
**Red = 120V**  
**Purple = Class 2 Wire**  
**Blue = 12VDC**

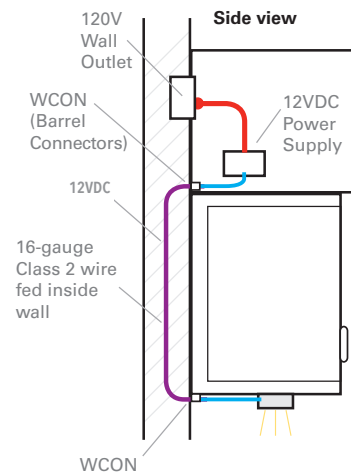
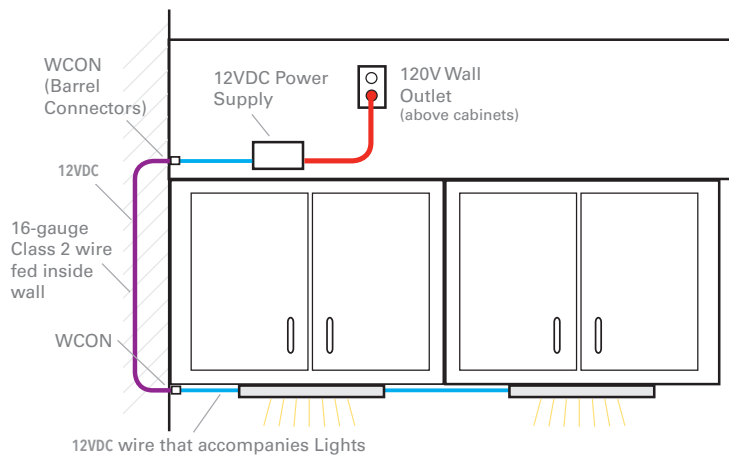

## OUTSIDE of Wall Wiring:

### Typical for FRAMED Cabinets

(example installation of 12VDC Pocket® Lights)

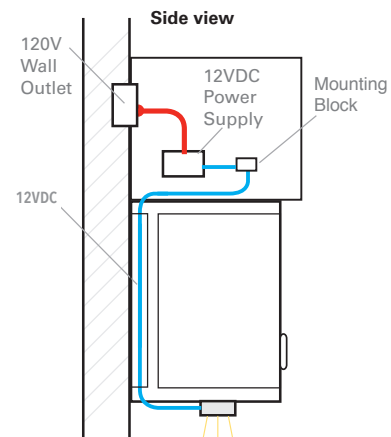
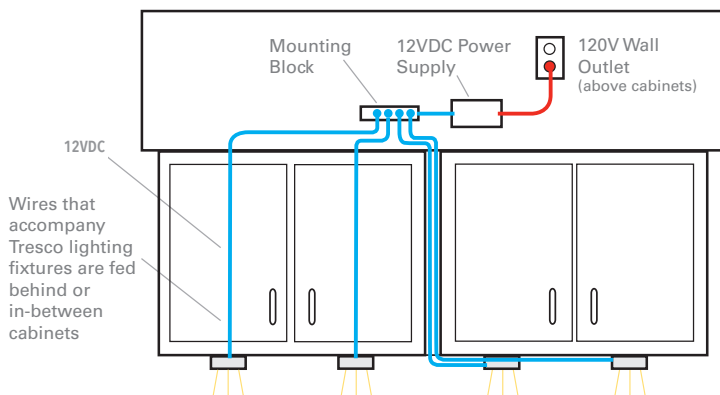

## Length of Wire from Power Supply to Run of Lights

This is a general guide based on a 60 Watt/5 Amp load:

- Recommended maximum length using Class 2, 16-gauge (AWG) wire = 7.6 meters (25 ft.)
- Recommended maximum length using links/extensions that accompany Tresco lights = 4.6 meters (15 ft.)



# Use D.I.Y. Connectors with Class 2 Wire For Making Junction Between In-Wall Wiring and Light Fixture Wire

**Note:** A licensed electrician should be consulted for wiring through walls and other permanent structures. When mounting and wiring a light system, follow all local electric codes and the National Electrical Code (NEC).

- Wires that are attached to or accompany Tresco lighting systems are not approved for in-wall use. Class 2, 16-gauge wires must be used (purchased separately). Class 2, 16-gauge wire is the minimum for in-wall applications.

## Items required for in-wall installation:

- (10) Barrel Connectors White . . . . . L-LED-WCON-WH-1  
Black . . . . . L-LED-WCON-BL-1
- Class 2, 16 AWG wire White, 15.2 m (50 ft.) roll . . . L-16CL2-WH50-1
- Small screwdriver Black, mini slotted . . . . . L-MFSCRWDR-1

**Note:** Make sure electrical polarity (positive and negative) is correctly maintained when making junction between Class 2 wire and Light Fixture wire.

- (+) Red to (+) Red
- (-) Black to (-) Black

Note: Fixture wires are tagged (+) (-) when red- and black-colored wires are not utilized.

### WCON - Barrel Connectors

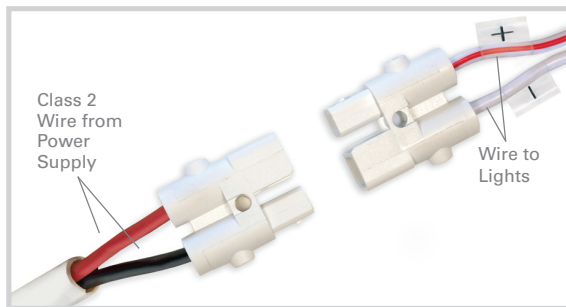

### Class 2 Wire



## Typical IN-WALL Wiring with Kitchen Cabinets

(example installation of 12V Linear Lights)

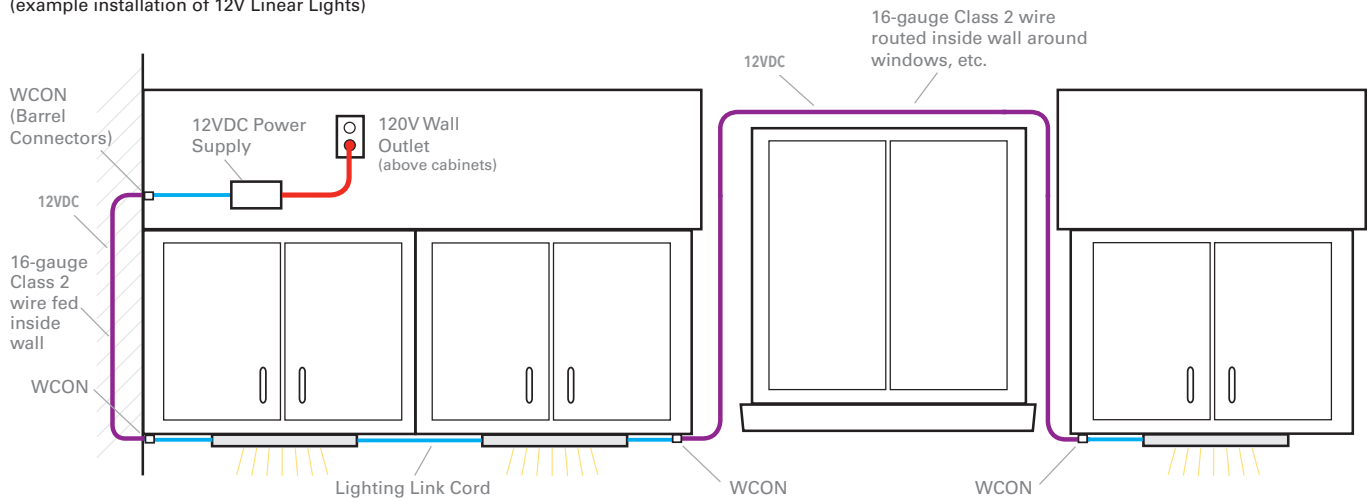

# Understanding Voltage Drop

## When Installing Tresco 12VDC Lighting Pockit® (Puck) Light Series

- **Note:** The information provided for measuring voltage drop is a general guide only based on the length of the run and assuming 50% load (30W). Voltage drop goes down with less load and voltage drop goes up with more load. Other factors may influence voltage drop. All measurements and calculations are approximate.
- **In-wall wiring:** Wires that are attached to or accompany Tresco lighting systems are not approved for in-wall use. Class 2, 16-gauge (AWG) wires must be used (purchased separately).
- All Tresco Power Supplies can be applied to the information provided herein on voltage drop.

**Ideally, Voltage Drop variance should be within 5%. Absolute maximum should never exceed 8%.**

- Recommended maximum length using links/extensions that accompany Tresco lights = 4.6 meters (15 ft.).
- Recommended maximum length using Class 2, 16-gauge wire = 7.6 meters (25 ft.).

**Voltage drop** is the amount of electric current lost due to the resistance of the conductors (wires).

On most installations – even larger installations – voltage drop is not an issue, but excessive voltage drop could result in diminished light output. Keeping wire length in mind is a best practice to ensure optimum light performance.

For instance, if specifications recommend that the maximum length from Power Supply to the first Light not exceed 5 meters (16 ft.), **the light will still work if you exceed that length!** Again the loss is gradual, but an excessive length could result in dimmer light.

Other factors also influence voltage drop, including the number of connectors, quality of the conductor (aluminum vs. copper wires), and cross-sectional area (gauge).

All Tresco wires and cords provided are specifically for wiring **outside of walls** and have a 4.6 meters (15 ft.) maximum length recommendation.

For **in-wall wiring**, stranded Class 2, 16-gauge wires must be used (purchased separately). Also if needed, lower gauge (which means larger wire) helps reduce voltage drop by lowering overall resistance.

### 12V Pockit® Lights (Puck)

#### Example 1:

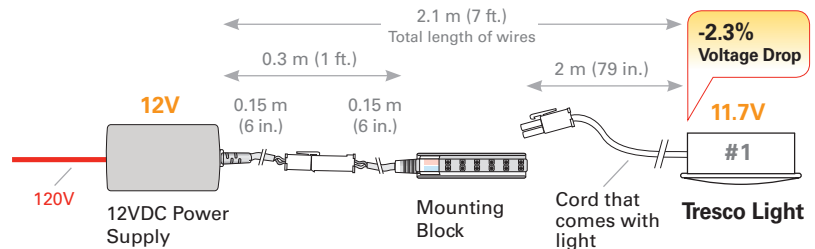

#### Example 2:

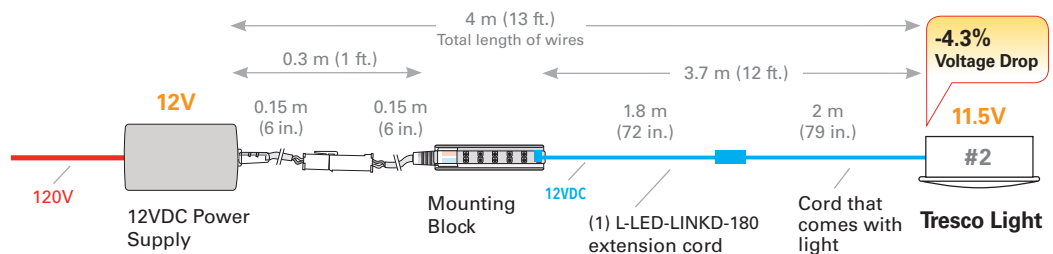

#### Example 3:

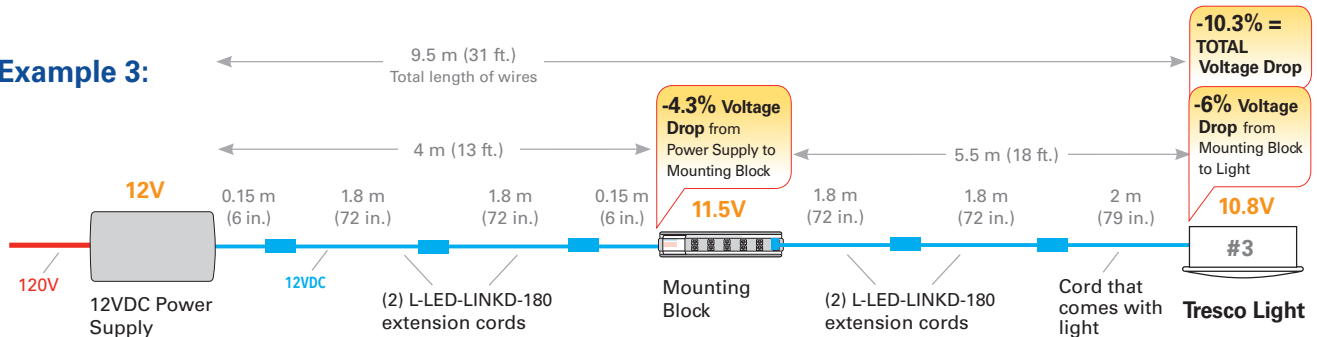

**Note:** The overall Voltage Drop variance between Light #1 and Light #3 is **8%**, which is noticeable.

# Understanding Voltage Drop

## When Installing Tresco 12VDC Lighting Linear Linkable Series

Tresco's longest linking cords are 2 meters (79 in.) which is only a 2% voltage drop – without a noticeable difference in light output.

- **Note:** The information provided for measuring voltage drop is a general guide only based on the length of the run and assuming 50% load (30W). Voltage drop goes down with less load and voltage drop goes up with more load. Other factors may influence voltage drop. All measurements and calculations are approximate.

### 12V Linear Lights Linked in Series Using Link Cords

Linear Lights are typically within 1 meter (3 ft.) of each other without a noticeable voltage drop (less than 1%).

#### Example 1:

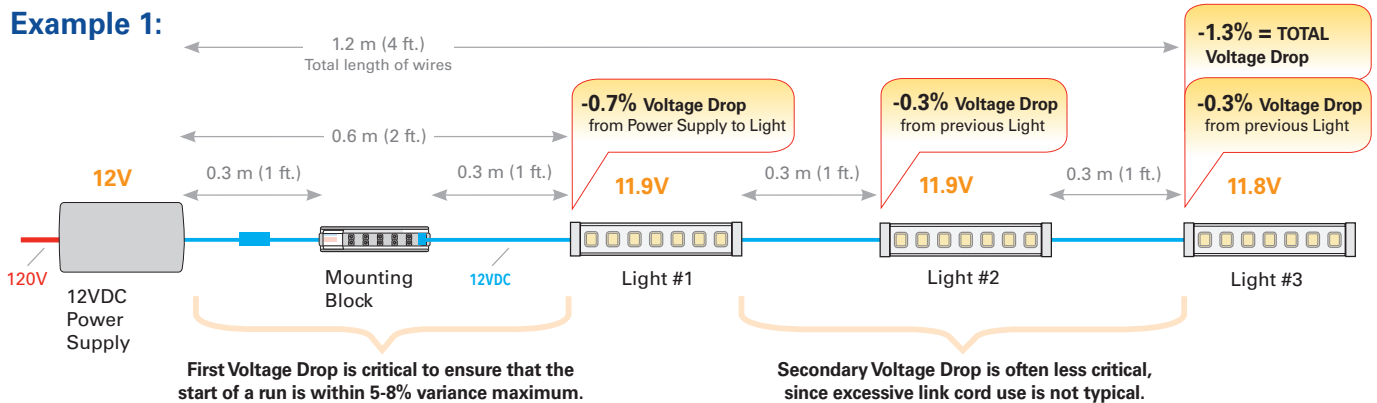

The total Voltage Drop is 1.3% with a variance between Light #1 and Light #3 of 0.6% which is not noticeable.

#### Example 2:

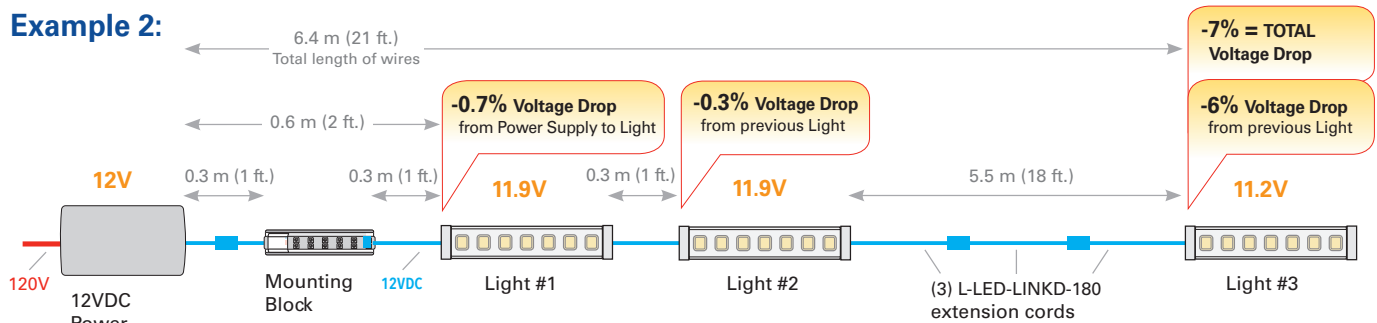

The total Voltage Drop is 7% with a variance between Light #1 and Light #3 of 6.3% which is not noticeable.

#### Example 3:

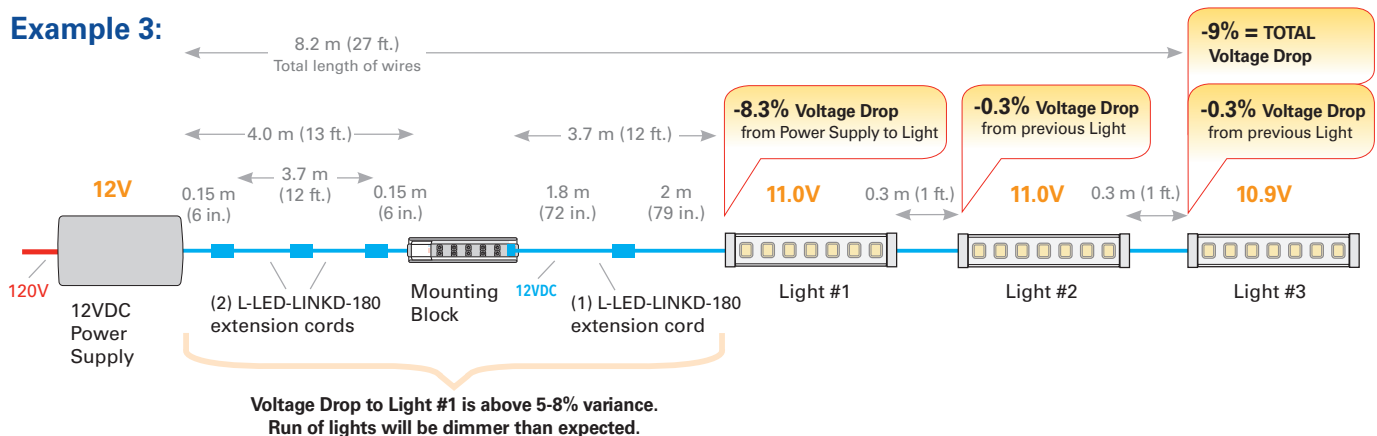

Voltage Drop to Light #1 is above 5-8% variance. Run of lights will be dimmer than expected.

The total Voltage Drop is 9% with a variance between Light #1 and Light #3 of 0.7% which is not noticeable.

## Contents

L-12DCH60X1-1.....	42, 63, 84	L-DC-SLELT60-1.....	42, 63, 84, 150	L-FLXTPE-30RH-1.....	82
L-12DCH60X1-1*.....	154	L-DCE30D-CON-1.....	42, 63, 84, 153	L-FLXTPE-30RS-1.....	82
L-12DCH60X3-1.....	42, 63, 84	L-DCE60D-CON-1.....	42, 63, 84, 153	L-FLXTPE-30RU-1.....	82
L-12DCH60X3-1*.....	154	L-DSL06-1LZ-1.....	45, 159	L-FLXTPE-30RV-1.....	82
L-16CL2-WH50-1.....	176, 179	L-DVCL-153P-WH-1.....	45, 159	L-FLXTPE-35EER-1.....	83
L-1BRL5-1.....	86, 112, 113, 155, 156, 157	L-EQW-1REC-1.....	166	L-FLXTPE-35RU-1.....	82
L-24B2SPKT-2M-1.....	86, 113, 147	L-EUL2-GTD2-1.....	62	L-FLXTPE-48EER-1.....	83
L-24B2SPKT-2M-TEE-1.....	86, 113	L-EUL11W2-806CAL-1.....	62	L-FLXTPE-48RU-1.....	82
L-24B2SPKT-305MM-1.....	86, 113, 147	L-EUL11W2-806WAL-1.....	62	L-FLXTPE-65EER-1.....	83
L-24B2SPKT-3M-1.....	86, 113, 147	L-EUL15W2-1111CAL-1.....	62	L-FLXTPE-65RU-1.....	82
L-24BBEXT-1M-1.....	86, 97, 112, 113, 177	L-EUL15W2-1111WAL-1.....	62	L-FLXTPE-CRV-1.....	82
L-24BBEXT-2M-1.....	86, 97, 112, 113, 177	L-EUL3W2-197CAL-1.....	62	L-FLXTPE-DRV-1.....	82
L-24BBEXT-3M-1.....	86, 97, 112, 113, 177	L-EUL3W2-197WAL-1.....	62	L-FLXTPE-NRV-1.....	82
L-24DCELT15WP-1.....	86, 112, 113, 156	L-EUL4W2-273CAL-1.....	62	L-FLXTPE-WRV-1.....	82
L-24DCELT48-BL-1.....	86, 112, 113, 155	L-EUL4W2-273WAL-1.....	62	L-FPOC-HWB-ADP-BL-1.....	45
L-24DCELT96-1.....	86, 112, 113, 155	L-EUL7W2-502CAL-1.....	62	L-FPOC-HWB-ADP-WH-1.....	45
L-24DCH96X1-1.....	86, 112, 113	L-EUL7W2-502WAL-1.....	62	L-FPOC-LINKA-120-BL-1.....	44
L-24DCH96X1-1*.....	157	L-EULNK2-120-WH-1.....	62	L-FPOC-LINKA-120-WH-1.....	44
L-24DCH96X3-1.....	86, 112, 113	L-EULNK2-15-WH-1.....	62	L-FPOC-LINKA-180-BL-1.....	44
L-24DCH96X3-1*.....	157	L-EULNK2-180-WH-1.....	62	L-FPOC-LINKA-180-WH-1.....	44
L-24VDC3INADP-BL-1.....	171, 174, 175	L-EULNK2-25-WH-1.....	62	L-FPOC-LINKA-25-BL-1.....	44
L-24VDC3INADP-WH-1.....	171, 174, 175	L-EULNK2-60-WH-1.....	62	L-FPOC-LINKA-25-WH-1.....	44
L-24XPKT-2M-BL-1.....	147	L-EXTBTB10-1.....	147	L-FPOC-LINKA-60-BL-1.....	44
L-24XPKT-2M-WH-1.....	147	L-EXTMP-VHB-1.....	147	L-FPOC-LINKA-60-WH-1.....	44
L-4P60-1.....	123, 133	L-FLXCOB12-27RV-1.....	84	L-HWB-BL-T5-1.....	44, 64
L-ADJTKIT-BL-1.....	41	L-FLXCOB12-30RV-1.....	84	L-HWB-BL-T5-S-1.....	44, 64
L-ADJTKIT-NI-1.....	41	L-FLXCOB12-35RV-1.....	84	L-HWB-WH-T5-1.....	44, 64
L-ADJTKIT-WH-1.....	41	L-FLXCOB12-48RV-1.....	84	L-HWB-WH-T5-S-1.....	44, 64
L-BS4PBL-1.....	122, 133	L-FLXCOB12-65RV-1.....	84	L-LED-1EB-CBL-1.....	41
L-CCTEXT-120-1.....	123	L-FLXCOB24-27RU-1.....	86	L-LED-1EB-CNI-1.....	41
L-CCTEXT-60-1.....	123	L-FLXCOB24-30RU-1.....	86	L-LED-1EB-CWH-1.....	41
L-CCTWIRE25-1.....	122	L-FLXCOB24-35RU-1.....	86	L-LED-1EB-WBL-1.....	41
L-CTCL-153P-WH-1.....	45, 159	L-FLXCOB24-48RU-1.....	86	L-LED-1EB-WNI-1.....	41
L-DB1732-1.....	179	L-FLXCOB24-65RU-1.....	86	L-LED-1EB-WWH-1.....	41
L-DC-ELT15WP-CON-1.....	42, 63, 84, 152	L-FLXTPE-12CCT-1.....	122	L-LED-3DSP-CBL-1.....	41
L-DC-ELT6WP-CON-1.....	42, 63, 84	L-FLXTPE-12RGB-1.....	132	L-LED-3DSP-CNI-1.....	41
L-DC-EQ30-1.....	42, 63, 84	L-FLXTPE-24CCT-1.....	122	L-LED-3DSP-WBL-1.....	41
L-DC-EQ60-1.....	42, 63, 84, 152	L-FLXTPE-24RGB-1.....	132	L-LED-3DSP-WNI-1.....	41
L-DC-SLELT30-1.....	42, 63, 84, 150	L-FLXTPE-27EER-1.....	83	L-LED-AGLPR-1016CAL-1.....	62
		L-FLXTPE-27RU-1.....	82	L-LED-AGLPR-1016WAL-1.....	62



L-LED-AGLPR-250CAL-1.....	62	L-LED-SQPR-559CAL-1.....	63	L-LT514W-904W*-1.....	64
L-LED-AGLPR-250WAL-1.....	62	L-LED-SQPR-559WAL-1.....	63	L-LT518W-1204C*-1.....	64
L-LED-AGLPR-406CAL-1.....	62	L-LED-SQPR-864CAL-1.....	63	L-LT518W-1204D*-1.....	64
L-LED-AGLPR-406WAL-1.....	62	L-LED-SQPR-864WAL-1.....	63	L-LT518W-1204W*-1.....	64
L-LED-AGLPR-559WAL-1.....	62	L-LED-STK12-CNI-1.....	60	L-LT525W-1504C*-1.....	64
L-LED-AGLPR-711CAL-1.....	62	L-LED-STK12-WNI-1.....	60	L-LT525W-1504D*-1.....	64
L-LED-AGLPR-711WAL-1.....	62	L-LED-STK22-CNI-1.....	60	L-LT525W-1504W*-1.....	64
L-LED-AGLPR-864WAL-1.....	62	L-LED-STK22-WNI-1.....	60	L-LT53W-267C*-1.....	64
L-LED-DIMCON-BL-1.....	174	L-LED-STK8-CNI-1.....	60	L-LT53W-267D*-1.....	64
L-LED-DIMCON-WH-1.....	174	L-LED-STK8-WNI-1.....	60	L-LT53W-267W*-1.....	64
L-LED-DIMRMT-12V8A-1.....	171	L-LED-STKLNK-120-1.....	60	L-LT54W-343C*-1.....	64
L-LED-DIMRMT-12V8A-U-1*.....	171	L-LED-STKLNK-15-1.....	60	L-LT54W-343D*-1.....	64
L-LED-FLXTPE-BRHO-1.....	82	L-LED-STKLNK-180-1.....	60	L-LT54W-343W*-1.....	64
L-LED-FLXTPE-BROLL-1.....	82	L-LED-STKLNK-25-1.....	60	L-LT57W-571D*-1.....	64
L-LED-FLXTPE-CRHO-1.....	82	L-LED-STKLNK-5-1.....	60	L-LT57W-571W*-1.....	64
L-LED-FLXTPE-CROLL-1.....	82	L-LED-STKLNK-60-1.....	60	L-MALE-AMP-10-1.....	177, 179
L-LED-FLXTPE-DRHO-1.....	82	L-LED-TPELNK-120-1.....	85, 113	L-MF5CRWDR-1.....	178, 179
L-LED-FLXTPE-DROLL-1.....	82	L-LED-TPELNK-15-1.....	85, 113	L-MPOC-4W-120L-CBL-1.....	43
L-LED-FLXTPE-NRHO-1.....	82	L-LED-TPELNK-180-1.....	85, 113	L-MPOC-4W-120L-CNI-1.....	43
L-LED-FLXTPE-NROLL-1.....	82	L-LED-TPELNK-25-1.....	85, 113	L-MPOC-4W-120L-CWH-1.....	43
L-LED-FLXTPE-RRHO-1.....	82	L-LED-TPELNK-5-1.....	85, 113	L-MPOC-4W-120L-WBL-1.....	43
L-LED-FLXTPE-RROLL-1.....	82	L-LED-TPELNK-60-1.....	85, 113	L-MPOC-4W-120L-WNI-1.....	43
L-LED-FLXTPE-WRHO-1.....	82	L-LED-TPELNK-CON90-1.....	85	L-MPOC-4W-120L-WWH-1.....	43
L-LED-FLXTPE-WROLL-1.....	82	L-LED-TPELNK-TEE-1.....	85	L-MPOC-4W-120NL-CBL-1.....	43
L-LED-LINKD-120-1.....	43, 63, 96, 177	L-LED-TPEPKT-2M-1.....	84, 147	L-MPOC-4W-120NL-CNI-1.....	43
L-LED-LINKD-15-1.....	43, 63, 96, 177	L-LED-TPEPKT-2M-TEE-1.....	84	L-MPOC-4W-120NL-CWH-1.....	43
L-LED-LINKD-180-1.....	43, 63, 96, 177	L-LED-WCON-BL-1.....	176, 179	L-MPOC-4W-120NL-WBL-1.....	43
L-LED-LINKD-245-1.....	43, 63, 96, 177	L-LED-WCON-WH-1.....	176, 179	L-MPOC-4W-120NL-WNI-1.....	43
L-LED-LINKD-25-1.....	43, 63, 96, 177	L-LT5-HWBADP-BL-1.....	64	L-MPOC-4W-120NL-WWH-1.....	43
L-LED-LINKD-60-1.....	43, 63, 96, 177	L-LT5-HWBADP-WH-1.....	64	L-MPOC-PKT8-BL-1.....	43
L-LED-LINKD-8-1.....	43, 63, 96, 177	L-LT5-LNK120-BL-1.....	64	L-MPOC-PKT8-WH-1.....	43
L-LED-SMPLNK-120-1.....	61	L-LT5-LNK120-WH-1.....	64	L-N1-12PKT-2M-1.....	96
L-LED-SMPLNK-15-1.....	61	L-LT5-LNK15-BL-1.....	64	L-N1-12V3WM-27K-5M-1.....	96
L-LED-SMPLNK-180-1.....	61	L-LT5-LNK15-WH-1.....	64	L-N1-12V3WM-30K-5M-1.....	96
L-LED-SMPLNK-25-1.....	61	L-LT5-LNK180-BL-1.....	64	L-N1-12V3WM-35K-5M-1.....	96
L-LED-SMPLNK-5-1.....	61	L-LT5-LNK180-WH-1.....	64	L-N1-12V3WM-48K-5M-1.....	96
L-LED-SMPLNK-60-1.....	61	L-LT5-LNK25-BL-1.....	64	L-N1-12V3WM-65K-5M-1.....	96
L-LED-SMPTD4-1.....	61	L-LT5-LNK25-WH-1.....	64	L-N1-24PKT-2M-1.....	97
L-LED-SQPR-1016CAL-1.....	63	L-LT5-LNK60-BL-1.....	64	L-N1-24V3WM-27K-8M-1.....	96
L-LED-SQPR-250WAL-1.....	63	L-LT5-LNK60-WH-1.....	64	L-N1-24V3WM-30K-8M-1.....	96
L-LED-SQPR-406WAL-1.....	63	L-LT514W-904C*-1.....	64	L-N1-24V3WM-35K-8M-1.....	96

L-N1-24V3WM-48K-8M-1.....	96	L-POC-3LEDSFR-NBL-1.....	40	L-S16001WA-1.....	186
L-N1-24V3WM-65K-8M-1.....	96	L-POC-3LEDSFR-NNI-1.....	40	L-S16001WI000-1.....	45, 158
L-N1-BTB-1.....	97	L-POC-3LEDSFR-WAB-1.....	40	L-SD3001WA-1.....	187
L-N1-ENDCAP-1.....	97	L-POC-3LEDSFR-WBL-1.....	40	L-SD300WI000-1.....	45, 158
L-N1-LNK**-1.....	97	L-POC-3LEDSFR-WCH-1.....	40	L-SMPHO12-CNI-1.....	61
L-N1-LNK120-1.....	97	L-POC-3LEDSFR-WNI-1.....	40	L-SMPHO12-WNI-1.....	61
L-N1-LNK180-1.....	97	L-POC-3LEDSFR-WORB-1.....	40	L-SMPHO22-CNI-1.....	61
L-N1-LNK25-1.....	97	L-POC-3LEDSFR-WWH-1.....	40	L-SMPHO22-WNI-1.....	61
L-N1-LNK60-1.....	97	L-POC-4CCT24-BL-1.....	123	L-SMPHO8-CNI-1.....	61
L-N1-UCLP-1.....	97	L-POC-4CCT24-NI-1.....	123	L-SMPHO8-WNI-1.....	61
L-N2-12PKT-2M-1.....	96	L-POC-4CCT24-WH-1.....	123	L-SMR-2LED-BL-1.....	42
L-N2-12V3WM-27K-5M-1.....	96	L-POC-5ADJ-C-1.....	41	L-SMR-2LED-NI-1.....	42
L-N2-12V3WM-30K-5M-1.....	96	L-POC-5ADJ-W-1.....	41	L-SP15WA-30K-1.....	112
L-N2-12V3WM-35K-5M-1.....	96	L-POC-5LEDSCL-CBL-1.....	40	L-SP15WA-40K-1.....	112
L-N2-12V3WM-48K-5M-1.....	96	L-POC-5LEDSCL-CNI-1.....	40	L-SP15WA-50K-1.....	112
L-N2-12V3WM-65K-5M-1.....	96	L-POC-5LEDSCL-CWH-1.....	40	L-SP15WA-65K-1.....	112
L-N2-24PKT-2M-1.....	97	L-POC-5LEDSCL-WBL-1.....	40	L-SP3TCS-1.....	112
L-N2-24V3WM-27K-8M-1.....	96	L-POC-5LEDSCL-WNI-1.....	40	L-SP6TCS-1.....	112
L-N2-24V3WM-30K-8M-1.....	96	L-POC-5LEDSCL-WORB-1.....	40	L-SP8WA-30K-1.....	112
L-N2-24V3WM-35K-8M-1.....	96	L-POC-5LEDSCL-WWH-1.....	40	L-SP8WA-40K-1.....	112
L-N2-24V3WM-48K-8M-1.....	96	L-R1020SWA-1.....	185	L-SP8WA-50K-1.....	112
L-N2-24V3WM-65K-8M-1.....	96	L-R1020WI000-1.....	158	L-SP8WA-65K-1.....	112
L-N2-BTB-1.....	97	L-RDSW-1M-120-BL-1.....	44	L-SP90BTB4-1.....	112
L-N2-ENDCAP-1.....	97	L-RDSW-1M-120-WH-1.....	44	L-SPBTB10-1.....	112
L-N2-LNK**-1.....	97	L-RDSW-1M-BL-1.....	175	L-SPFL15WA-30K-1.....	113
L-N2-LNK120-1.....	97	L-RDSW-1M-WH-1.....	175	L-SPFL15WA-40K-1.....	113
L-N2-LNK180-1.....	97	L-RDSW-2M-120-BL-1.....	44	L-SPFL15WA-50K-1.....	113
L-N2-LNK25-1.....	97	L-RDSW-2M-120-WH-1.....	44	L-SPFL15WA-65K-1.....	113
L-N2-LNK60-1.....	97	L-RDSW-2M-BL-1.....	175	L-SPFL8WA-30K-1.....	113
L-N2-UCLP-1.....	97	L-RDSW-2M-WH-1.....	175	L-SPFL8WA-40K-1.....	113
L-P15SCRWDR-1.....	178, 179	L-RGBCCT-RMT-1.....	123, 132, 170	L-SPFL8WA-50K-1.....	113
L-PINEXT-1.....	177, 179	L-RGBCCT1-CREC-1.....	168	L-SPFL8WA-65K-1.....	113
L-POC-3EQFR-CBL-1.....	42	L-RGBCCT1-CREC-1*.....	123, 132	L-SPLNK120-1.....	112
L-POC-3EQFR-CNI-1.....	42	L-RGBCCT1-PREC-1.....	123, 132, 168	L-SPLNK25-1.....	112
L-POC-3EQFR-WBL-1.....	42	L-RGBEXT-120-1.....	133	L-SPLNK60-1.....	112
L-POC-3EQFR-WNI-1.....	42	L-RGBEXT-60-1.....	133	L-SPLNK8-1.....	112
L-POC-3LEDSFR-CAB-1.....	40	L-RGBWIRE25-1.....	133	L-SPPKT-1M-1.....	112
L-POC-3LEDSFR-CBL-1.....	40	L-RSDIM-**-1.....	172	L-SPPKT-305MM-1.....	112
L-POC-3LEDSFR-CCH-1.....	40	L-RSDS-**-1.....	172	L-SPPKT-3M-1.....	112
L-POC-3LEDSFR-CNI-1.....	40	L-RSDS2-**-1.....	172	L-STKH012-CNI-1.....	60
L-POC-3LEDSFR-CWH-1.....	40	L-RSMOT-NI-1.....	172	L-STKH012-WNI-1.....	60

L-STKHO22-CNI-1.....	60	L-TPEPKT-2M-CCT-1.....	122	L-XLNK-120-**-1.....	147
L-STKHO22-WNI-1.....	60	L-TPEPKT-2M-RGB-1.....	132	L-XLNK-15-**-1.....	147
L-STKHO34-CNI-1.....	60	L-TRANS-MNT-BL-1.....	150, 151, 152, 153, 154, 179	L-XLNK-180-**-1.....	147
L-STKHO34-WNI-1.....	60	L-TR55-UCLP-M-1.....	64	L-XLNK-25-**-1.....	147
L-STKHO8-CNI-1.....	60	L-VHBTPE-1134-1.....	177, 179	L-XLNK-60-**-1.....	147
L-STKHO8-WNI-1.....	60	L-WCLP-WH-1.....	179	L-XPKT-2IN-BL-1.....	147
L-TOOLKIT-1.....	179	L-WI000UWA-1.....	188	L-XPKT-2IN-WH-1.....	147
L-TPE-BTB-CCT-1.....	122	L-WI001UWA-1.....	189	L-XPKT-2M-BL-1.....	147
L-TPE-BTB-RGB-1.....	133	L-WI002UWA-1.....	188	L-XPKT-2M-WH-1.....	147
L-TPELED-24RGB-1.....	132	L-WI004UWA-1.....	189	L-XREC72-BL-1.....	146
L-TPELED-27HER-1.....	83	L-WLD-1REC-1.....	160, 161, 162, 163	L-XREC72-SC-1.....	146
L-TPELED-27SER-1.....	83	L-WLD-1RND-BL-1.....	162	L-XREC94-BL-1.....	146
L-TPELED-30HER-1.....	83	L-WLD-1RND-NI-1.....	162	L-XREC94-SC-1.....	146
L-TPELED-30SER-1.....	83	L-WLD-1WAL-**-1.....	161	L-XRECCBOYY-XX-1.....	173
L-TPELED-35HER-1.....	83	L-WLD-2WAL-**-1.....	161	L-XRECDIMA-XX-1.....	173
L-TPELED-35SER-1.....	83	L-WLD-3RMT-BL-1.....	163	L-XRECECP-BL-1.....	146
L-TPELED-48HER-1.....	83	L-WLD-CCT-WH-1.....	123, 169	L-XRECECP-GY-1.....	146
L-TPELED-48SER-1.....	83	L-WLD-RGB-WH-1.....	132, 169	L-XRM42-155-1.....	147
L-TPELED-65HER-1.....	83	L-WLDS-BL-1.....	165	L-XRND-UCLP-1.....	147
L-TPELED-65SER-1.....	83	L-WLDS-NI-1.....	165	L-XRND72-BL-1.....	146
L-TPELED2-27VER-1.....	83	L-WLDSREC-1.....	164	L-XRND72-SC-1.....	146
L-TPELED2-30VER-1.....	83	L-WM5-BL-1.....	176	L-XRNDRCBOYY-XX-1.....	173
L-TPELED2-35VER-1.....	83	L-WM5-BR-1.....	176	L-XRNDDDIMA-XX-1.....	173
L-TPELED2-48VER-1.....	83	L-WM5-WH-1.....	176	L-XRNDECP-BL-1.....	146
L-TPELED2-65VER-1.....	83	L-X**-DIFF-CL-1.....	146	L-XRNDECP-GY-1.....	146
L-TPELNK-BTB-1.....	85	L-X**-DIFF-FR-1.....	146	L-XSBTB-1.....	85, 113
L-TPELNK120-CCT-1.....	122	L-X**-DIFF-MLK-1.....	146	L-XSQR-UCLP-1.....	147
L-TPELNK120-RGB-1.....	133	L-XANG72-**-1.....	146	L-XSQR72-**-1.....	146
L-TPELNK15-CCT-1.....	122	L-XANG72-SC-1.....	146	L-XSQR72-SC-1.....	146
L-TPELNK15-RGB-1.....	133	L-XANGCBOYY-XX-1.....	173	L-XSQRCBOYY-XX-1.....	173
L-TPELNK180-CCT-1.....	122	L-XANGDIMA-XX-1.....	173	L-XSQRDIMA-XX-1.....	173
L-TPELNK180-RGB-1.....	133	L-XANGCECP-**-1.....	146	L-XSQRECP-**-1.....	146
L-TPELNK25-CCT-1.....	122	L-XANGCECP-GY-1.....	146	L-XSQRECP-GY-1.....	146
L-TPELNK25-RGB-1.....	133	L-XCRV72-**-1.....	146	L-XSQRSWCLP-1.....	147
L-TPELNK5-CCT-1.....	122	L-XCRV72-SC-1.....	146		
L-TPELNK5-RGB-1.....	133	L-XCRVCBOYY-XX-1.....	173		
L-TPELNK60-CCT-1.....	122	L-XCRVDIMA-XX-1.....	173		
L-TPELNK60-RGB-1.....	133	L-XCRVECP-**-1.....	146		
L-TPEPKT-2IN-1.....	84, 147	L-XCRVECP-GY-1.....	146		
L-TPEPKT-2IN-CCT-1.....	122	L-XFL72-SC-1.....	146		
L-TPEPKT-2IN-RGB-1.....	132	L-XFL94-SC-1.....	146		











1-800-227-1171 | [trescolighting.com](http://trescolighting.com)

